

The Alexandrian Corinthian Capital and its Role in the Evolution of the Corinthian Order in Hellenistic, Roman, and Late Roman Architecture

A Comparative Study
(3rd century BC - 7th century AD)

Ahmed M. Bassioni



Access Archaeology



About Access Archaeology

Access Archaeology offers a different publishing model for specialist academic material that might traditionally prove commercially unviable, perhaps due to its sheer extent or volume of colour content, or simply due to its relatively niche field of interest. This could apply, for example, to a PhD dissertation or a catalogue of archaeological data.

All *Access Archaeology* publications are available as a free-to-download pdf eBook and in print format. The free pdf download model supports dissemination in areas of the world where budgets are more severely limited, and also allows individual academics from all over the world the opportunity to access the material privately, rather than relying solely on their university or public library. Print copies, nevertheless, remain available to individuals and institutions who need or prefer them.

The material is refereed and/or peer reviewed. Copy-editing takes place prior to submission of the work for publication and is the responsibility of the author. Academics who are able to supply print-ready material are not charged any fee to publish (including making the material available as a free-to-download pdf). In some instances the material is type-set in-house and in these cases a small charge is passed on for layout work.

Our principal effort goes into promoting the material, both the free-to-download pdf and print edition, where *Access Archaeology* books get the same level of attention as all of our publications which are marketed through e-alerts, print catalogues, displays at academic conferences, and are supported by professional distribution worldwide.

The free pdf download allows for greater dissemination of academic work than traditional print models could ever hope to support. It is common for a free-to-download pdf to be downloaded hundreds or sometimes thousands of times when it first appears on our website. Print sales of such specialist material would take years to match this figure, if indeed they ever would.

This model may well evolve over time, but its ambition will always remain to publish archaeological material that would prove commercially unviable in traditional publishing models, without passing the expense on to the academic (author or reader).



The Alexandrian Corinthian Capital and its Role in the Evolution of the Corinthian Order in Hellenistic, Roman, and Late Roman Architecture

**A Comparative Study
(3rd century BC - 7th century AD)**

Ahmed M. Bassioni

Access Archaeology





ARCHAEOPRESS PUBLISHING LTD
Summertown Pavilion
18-24 Middle Way
Summertown
Oxford OX2 7LG
www.archaeopress.com

ISBN 978-1-80327-239-9
ISBN 978-1-80327-240-5 (e-Pdf)

© Ahmed M. Bassioni and Archaeopress 2022

All rights reserved. No part of this book may be reproduced, stored in retrieval system, or transmitted, in any form or by any means, electronic, mechanical, photocopying or otherwise, without the prior written permission of the copyright owners.

This book is available direct from Archaeopress or from our website www.archaeopress.com

Table of Contents

Preface	3
Introduction	6
Chapter I:	
The Creation of the Alexandrian Corinthian Capital in Context of Hellenistic Architecture	24
Corinthian Capitals of the Hellenistic World (Excluding Egypt)	13
The Alexandrian Corinthian Capital: Typology and Analysis	24
Corinthian, Corinthianized, and Blocked-Out Capitals from the Ptolemaic and Nabataean Kingdoms. 46	
Chapter II:	
Italo-Hellenistic, Late Republican, and Roman Imperial Corinthian Capitals.....	62
Italo-Hellenistic and Roman Republican Corinthian Capitals – Examples from Rome and Italy	52
Augustan Architecture and the Rise of the Canonical Roman Orthodox Corinthian Capital	81
Alexandrian and Egyptian Corinthian Capitals between 1st Century BC and 1st Century AD	86
Post-Augustan Corinthian Capitals until the 4th Century AD	101
Alexandrian and Egyptian Roman Corinthian Capitals	117
Chapter III:	
Late Antique Corinthian Capitals from Alexandria and the Byzantine World	131
Corinthian, Corinthianized, and Corinthian-related Capitals in Late Antique Alexandria and Egypt .	132
The Alexandrian Corinthian Capitals in Byzantine Architecture	152
Conclusion	167
Bibliography	171
Appendices	https://doi.org/10.32028/9781803272399-online



Acknowledgments

I dedicate this humble academic work to the memory of my grandfather; a historian with little luck but of great knowledge. Without him, I would have never been a fan of history or archaeology.

I am grateful to my professors, of both fields. To my supervisor, Prof. Mona Haggag, who believed in my work and challenged my capability of producing a dissertation like no other in the field of Classical archaeology and architecture. To Prof. Sahar Hamouda, Professor of English literature, who believed in me, and my persistence and hard work, for being a literature student who can excel in a totally different field.

I am also grateful for the works of Ronczweski, who was the first to discuss the Alexandrian Corinthian capitals one hundred years before the publication of my dissertation; B. Tkaczow and her marvelous work about the architecture of Kom El-Dikka; J. McKenzie and her masterpiece about Alexandrian architecture that inspired me to challenge the odds and over the same period on a much large scale of land; and finally Prof. P. Pensabene, whose book about Alexandrian architecture was the corner stone of my work and opened my eyes on a world of minute details that widened my perspective of the discussed subject.

“What is now proved was once only imagined.”

— William Blake

List of Figures

Figure 1. A reconstruction of the Corinthian capital from the Temple of Bassae, Greece	18
Figure 2. A reconstruction of a Corinthian capital from the Monument of Lysicrates, Athens, Greece	18
Figure 3. A reconstruction of a Corinthian capital from the Tholos of Delphi, Greece	19
Figure 4. A reconstruction of a Corinthian capital from the Tholos of Olymia, Greece	19
Figure 5. A reconstruction of a Corinthian capital from the Temple of Athena Alea, Tegea, Asia Minor	20
Figure 6. A reconstruction of a Corinthian capital from the Temple of Zeus at Nemea, Asia Minor	20
Figure 7. A reconstruction of a Corinthian capital from the Tholos of Epidaurus, Greece	21
Figure 8. A reconstruction of a Corinthian capital from the Philippium, Macedonia, Greece	21
Figure 9. A sketch of the Corinthian capital of the Temple of Apollo Didyma	25
Figure 10. A Corinthian capital from the temple of Zeus Olbius	26
Figure 11. A sketch of the Corinthian capital of the Temple of Zeus Olympius	26
Figure 12. A sketch of the Corinthian capital from the Hypostyle Hall in Ai-Khanoum	28
Figure 13. A Corinthian capital from the Propylon of Ai-Khanoum	28
Figure 14. A Corinthian capital from the Tomb at Belevi	29
Figure 15. A sketch of the Corinthian capital from the Propylon at Miletus	29
Figure 16. A sketch of the Corinthian capital from the Monument of Laodike	30
Figure 17. A sketch of the Corinthian capital of the Type I Alexandrian Corinthian capital	32
Figures 18-21. Type I Alexandrian Corinthian capitals from the Graeco-Roman Museum in Alexandria (concave helices with cauliculi)	34
Figure 22. The Type I Alexandrian Corinthian capital at the Khartoum Square in Alexandria	35
Figure 23. A Corinthian pilaster from the Mostafa Pasha Necropolis in Alexandria	35
Figures 24-25. Type I Alexandrian Corinthian capital from the Graeco-Roman Museum in Alexandria (concave helices without cauliculi)	35
Figures 26-28. Type I Alexandrian Corinthian capital from the Graeco-Roman Museum in Alexandria (convex helices with cauliculi)	36
Figures 29-33. Free Type I Alexandrian Corinthian capitals/pilasters from the Graeco-Roman Museum in Alexandria	37
Figures 34. An Egyptianized Type I Alexandrian Corinthian capital from the Graeco-Roman Museum in Alexandria	38
Figure 35. A sketch of the Type II Alexandrian Corinthian capital	38
Figures 36-39. Type II Alexandrian Corinthian capitals from the Graeco-Roman Museum in Alexandria	39
Figure 40. An Egyptianized Type II Alexandrian Corinthian capital from the Graeco-Roman Museum in Alexandria	39
Figure 41. A sketch of the Type III Alexandrian Corinthian capital	39

Figure 42. A double Type III Alexandrian Corinthian capital from the Graeco-Roman Museum in Alexandria	40
Type 43. A mixed Type III Alexandrian Corinthian capital from the Graeco-Roman Museum in Alexandria	41
Figure 44. A sketch of the Type IV Alexandrian Corinthian capital	41
Figure 45. A Type IV Alexandrian Corinthian capital from the Graeco-Roman Museum in Alexandria	42
Figure 46A-B. A Type IV Alexandrian Corinthian capital with a Gorgon head from the Graeco-Roman Museum in Alexandria	42
Figure 47. Type IV Alexandrian Corinthian capital with miander collar from the Graeco-Roman Museum in Alexandria	43
Figure 48. A fragment of a Type IV Alexandrian Corinthian capital with a miander collar from the Graeco-Roman Museum in Alexandria	43
Figure 49. A reduced Type IV Alexandrian Corinthian capital with a miander collar from the Graeco-Roman Museum in Alexandria	43
Figure 50. A two-block Type I Alexandrian Corinthian capital from the site of the Alexandrian Sarapeion	50
Figures 51-52. Two Type I Alexandrian Corinthian capitals from the construction site of Club Mohamed Ali, currently at the Graeco-Roman Museum in Alexandria	44
Figures 53-54. Reconstructions of the lower and upper levels of the Thalamegos of Ptolemy IV with their Corinthian capitals	45
Figure 55. A Type I Alexandrian Corinthian capital from the Ptolemaic Basilica at Hermopolis Magna, currently at the Graeco-Roman Museum, Alexandria	46
Figure 56. A Type I Alexandrian Corinthian capital with convex helices from Edfu	47
Figure 57. A Type II Alexandrian Corinthian capital fragment from Edfu	47
Figure 58. A Type IV Floral Corinthian capital fragment from Edfu	47
Figures 59 A-B. A double Type III Alexandrian Corinthian capital from Edfu	48
Figure 60. A Type I.A Free Alexandrian Corinthian capital from the procession at the Temple of Dandara	48
Figures 61-62. Two Type III Alexandrian Corinthian capitals from Dandara	48
Figure 63. A Type III Alexandrian Corinthian capital from Kom Ombo	49
Figure 64. A Type I Alexandrian Corinthian capital with convex helices without caulciuli from the Palazzo delle Colonne in Ptolemais, Cyrenaica	49
Figures 65-66. Two Type I Alexandrian Corinthian capitals from the Palazzo delle Colonne in Ptolemais, Cyrenaica	50
Figure 67. A proto-Italo- Corinthian capital from the Palazzo delle Colonne in Ptolemais, Cyrenaica	50
Figure 68. A reconstruction of the Type III Alexandrian Corinthian capital from the Palazzo delle Colonne in Ptolemais, Cyrenaica	50
Figure 69. A Type II Alexandrian Corinthian capital from the Palazzo delle Colonne in Ptolemais, Cyrenaica	50
Figures 70-71. Reconstructions of the Rotunda of Arsinoe at the Sanctuary of the Gods, Samothrace	51
Figure 72. A reconstruction of the Type I modified Alexandrian Corinthian capital from the Propylon of Ptolemy II at the Sanctuary of the Gods, Samothrace	52

Figure 73. A reconstruction of the Type I Floral Corinthian capital from El-Khazneh at Petra	53
Figure 74. A Type I Floral Corinthian capital from El-Khazneh at Petra	53
Figure 75. An upper capital fragment of a Type I.A Floral Corinthian capital from the Temple of Winged Lions, Petra	54
Figure 76. An upper capital fragment of a Type I.B Floral Corinthian capital from the Temple of Winged Lions, Petra	54
Figure 77. A Type III/Floral Alexandrian Corinthian capital from Petra	54
Figure 78. A reconstruction of the Type II Floral Corinthian capital	55
Figure 79. A Type II Floral Corinthian capital from El-Khazneh, Petra	55
Figure 80. A sketch of the Type I Nabataean/Blocked-Out capital	55
Figure 81. A sketch of the Type II Nabataean/Blocked-Out capital	55
Figure 82. The upper level of El-Deir/The Monastery at Petra with its Type II Nabataean/Blocked-Out capitals	55
Figure 83. A Type I Nabataean/Blocked-Out capital from a site near Wadi Mousa, Jordan	56
Figure 84. Tomb B-6 at Hegra	56
Figure 85. Tomb B-5 at Hegra	56
Figure 86. Tomb B-7 at Hegra	56
Figure 87. Tomb IGN 100 at Hegra	57
Figure 88. Tomb IGN 110 at Hegra	57
Figure 89. A sketch of the Type I Egyptian Composite capital	57
Figure 90. A sketch of the Type II Egyptian Composite capital	57
Figure 91. Helix-influenced Egyptian Composite capital from Alexandria	57
Figure 92. Egyptian Composite capitals from the Temple of Hathor	58
Figure 93. Egyptian Composite capitals from the Pronaos at the Birth House in Philae	59
Figure 94. Egyptian Composite capitals from the Second Eastern Colonnade at the Temple of Isis in Philae	59
Figure 95. Egyptian Composite capitals from the Hypostyle Hall and Eastern Colonnade at the Temple of Horus in Edfu	60
Figure 96. An Egyptian Composite capital from the Outer Hypostyle Hall of the Temple of Horus, Edfu	60
Figure 97. An Egyptian Composite capital from the Front Courtyard Hall of the Temple of Horus, Edfu	60
Figure 98. Temple of Haroeis and Sobek at Kom Ombo	
Figure 99. An Egyptian Composite capital from the Outer Hypostyle Hall of the Temple of Temple of Haroeis and Sobek at Kom Ombo	60
Figure 100. A reconstruction of the Corinthian capital from the Temple of Peace at Paestum	61
Figure 101. A reconstruction of the Italo-Corinthian capital from the Antiquarium at Solanto in Palermo	65
Figure 102. An Italo-Corinthian capital fragment from Taranto	65

Figure 103. A reconstruction of an incomplete (probably an Italo-Corinthian capital) from Porta Nocera	65
Figure 104. An Italo-Corinthian capital from Ravenna	66
Figures 105-6. Two Italo-Corinthian capitals (one incomplete, the other finished and intact) from the House of Augustus at Rome	66
Figure 107. A reconstruction of an Italo-Corinthian capital from the Temple of Vesta at Tivoli	66
Figures 108-9. Two Italo-Corinthian capitals from Rimini	67
Figure 110. An Italo-Corinthian capital from Bologna	67
Figure 111. An Italo-Corinthian capital from Verona	67
Figure 112. An Italo-Corinthian capital from Milan	67
Figure 113. An Italo-Corinthian capital from Aquileia	67
Figure 114. A reconstruction of an Italo-Corinthian capital from the Temple of Jupiter at Pompeii	68
Figure 115. A reconstruction of an Italo-Corinthian capital from the Basilica at Pompeii	68
Figure 116. An Italo-Corinthian capital from the Sanctuary of Apollo at Pompeii	69
Figure 117. A reconstruction of an Italo-Corinthian capital from the Sanctuary of Apollo at Pompeii	69
Figure 118. A reconstruction of an Italo-Corinthian capital from the House of the Faun at Pompeii	70
Figures 119-120. A reconstruction of two Italo-Corinthian capital from Boscoreale	70
Figure 121. A Second-Style Wall-Painting of a tholos with Corinthian capitals, Oecus 43, House of Labyrinth, Pompeii	71
Figure 122. A Second-Style Wall-Painting of a tholos with Corinthian capitals, Cubiculum 16, Villa of the Mysteries, Pompeii	71
Figure 123. A Second-Style Wall-Painting of a tholos with Corinthian capitals, Cubiculum M, Villa of Fannius Sinistor	72
Figures 124-125. Two Type IV Alexandrian Corinthian capital from Second-Style Wall-Painting styles at Pompeii	72
Figure 126. A set of Type IV Alexandrian/Proto-Composite capital from Second-Style Wall-Painting style at Boscoreale	72
Figure 127. A Late-Hellenistic Corinthian capital from the Round Temple by the Tiber, Rome	75
Figure 128. An Augustan Corinthian capital from the Round Temple by the Tiber, Rome	76
Figure 129. A lower drum of a Corinthian capital from Temple B, Largo Argentia, Rome	76
Figure 130. A reconstruction of a Corinthian capital from the Sanctuary of Fortuna Pirimigenia, Palestrina	76
Figure 131. A reconstruction of a Corinthian capital from the Temple of Castor and Pollux, Cori	77
Figure 132. Corinthian capitals from the Temple of Venus Genetrix, Rome	77
Figure 133. Denarius, 78 BC, Rome. RRC 385/1	79
Figure 134. Denarius, 43 BC, Rome. RRC 487/2b	79
Figure 135. Denarius, 43 BC, Rome. RRC 487/1	79
Figure 136. Denarius, AD 68-9, Gaul and Spain. RIC I second edition, Civil Wars 128a	79

Figure 137. A Palm-Leaf capital from the Tomb at Mylasa	81
Figure 138. A reconstruction of a Palm-Leaf capital from the Tower of Winds, Athens	81
Figure 139. A reconstruction of a Corinthian capital from Porticus Metelli, Rome	82
Figure 140. A reconstruction of a Corinthian capital from the Temple of Apollo Palatinus, Rome	83
Figure 141. Corinthian capitals from the Temple of Apollo Sosianus, Rome	83
Figure 142. A reconstruction of a Corinthian capital from the Temple of Mars Ultor, Rome	84
Figure 143. A reconstruction of a Corinthian capital from the Temple of Castor, Rome	84
Figure 144. An Italo-Corinthian capital from the Monument of Obulaccus, Sarsina	85
Figure 145. An Italo-Corinthian capital from the Pian di Bezzo Necropolis, Sarsina	85
Figures 146-147. Two Italo-Corinthian capitals from Villa A Oplontis, Boscoreale	86
Figure 148-9. Two Italo-Corinthian capitals from the Temple of Venus, Pompeii	87
Figure 150. A Corinthian capital from the Maison Carrée, Nîmes, France	88
Figure 151. A reconstruction of a Floral Corinthian capital from the Temple of Diana, Nîmes, France	88
Figure 152. A Corinthian capital from the Temple of Diana, Ébora, Portugal	88
Figure 153. A reconstruction of a Corinthian capital from the Temple of Sulis Minerva at Bath, England	89
Figure 154. A Corinthian capital from Templo Romano, Cordoba, Spain	89
Figure 155. Corinthian capitals of the Arch at Rimini, Italy	89
Figure 156. Corinthian capitals of the Arch at Aosta, Turin, Italy	90
Figure 157. Corinthian capitals of the Arch at Susa, Turin, Italy	90
Figure 158. Corinthian capitals of the Arch at Sergii, Pula, Coratia.....	90
Figure 159. Corinthian capitals of the Arch at Barà, Spain	91
Figure 160. Monuent of the Julii and the Arch, Glanum, Saint-Rémy-de-Provence, France	91
Figure 161. A Corinthian capital from the Odeion of Agrippa, Athens, Greece	92
Figure 162. A reconstruction of the Temple of Rome and Augustus at Ancyra, Asia Minor	92
Figure 163. A set of Corinthian caputals from the Temple of Jupiter-Baal, Baalbek	93
Figure 164A-B. Two Corinthian capitals and a Corinthian pilaster from the Temple of Bel, Palmyra	94
Figure 165. A Floral capital from Villa Medici, Rome	95
Figure 166. A Floral capital from the National Roman Museum	95
Figure 167. A Floral capital from the Museum of Naples	95
Figure 168. A capital from the Museum of Aquileia	95
Figure 169. A Floral capital reused at the Basilica of St. Clemente, Rome	95

Figures 170-171. Two Floral capitals from the Roman Antiquarium	95
Figures 172-174. Type III Floral/Alexandrian Corinthian capitals from Pompeii	95
Figure 175. A two-blocked Floral Corinthian capital from Seville, Spain	95
Figure 176. A Type IV Alexandrian capital from the Temple of Mars Ultor, Rome	95
Figure 177. A Type IV Alexandrian/Floral Corinthian capital from Pompeii	95
Figure 178. A sketch of Type IV Alexandrian/Floral Corinthian capital from the Arch at Susa, Italy	95
Figures 179. A sketch of Type IV Alexandrian/Floral Corinthian capital from the Lateran Museum, Rome	95
Figure 180. A sketch describing the design of helices used for Floral capitals in Rome	97
Figures 181-184. Several Floral Corinthian capitals from the Augustan period	97
Figures 185-187. Type I Alexandrian Corinthian capitals from the Graeco-Roman Museum, Alexandria	99
Figures 188-190. Type II Alexandrian Corinthian capitals from the Graeco-Roman Museum, Alexandria	99
Figure 191. A Type III Alexandrian Corinthian capital from the Graeco-Roman Museum, Alexandria	100
Figure 192. A Proto-Asiatic Corinthian capital from Hermopolis Magna	100
Figure 193. A two-block Blocked-Out capital from the Temple of Augustus, Philae	101
Figure 193A. A Blocked-Out capital from the Graeco-Roman Museum, Alexandria	101
Figure 194. A Type III Alexandrian Corinthian capital from Philae	101
Figure 194A. A sketch of a Type III Alexandrian Corinthian capital from Armant, Egypt	101
Figure 195. A medallion with a representation of the Roman Capitolium with Corinthian capitals	103
Figure 196. A fragment of a Corinthian capital unearthed at the site of the Roman Capitolium	103
Figure 197. A relief of the Emperor Marcus Aurelius and the Roman Capitolium in the Background	103
Figures 198-199. A Corinthian capital and two Corinthian pilasters from the Colosseum, Rome	104
Figure 200. A Corinthian capital from the Temple of Deified Vespasian, Rome	104
Figure 201. A Corinthian capital from the Forum of Nerva	105
Figures 202-204. Two Corinthian cpaitals and a Corinthian pilaster from the Pantheon, Rome	105
Figure 205. Corinthian capitals from the Canopus representation at Hadrian's Villa, Tivoli	107
Figure 206. A Corinthian capital from the Temple of Deified Hadrian, Rome	107
Figure 207. Temple of Faustina and Antoninus Pius, Rome	107
Figure 208. An Asiatic Corinthian capital from the Forum of Ostia	107
Figure 209. An Asiatic Corinthian capital from Brindisi, Italy	108
Figure 210. A sketch of two Corinthian capitals from the Baths of Diocletian, Rome	108
Figure 211. A <i>spoila</i> Corinthian capital from the Arch of Constantinople, Rome	109

Figures 212-213. Corinthian pilasters and a Corinthian capital from the Palace of Diocletian at Split, Croatia	109
Figure 214. A Corinthian capital from the Library of Hadrian, Athens	110
Figure 215. A Corinthian capital and a pilaster from the Gate of Hadrian, Athens	110
Figure 216. Corinthian capitals from the final version of the Olympieum, Athens	110
Figure 217. A reconstruction of a Corinthian capital from the monument of Philopappus, Athens	111
Figure 218. Corinthian pilasters from the Numphaeum of Herodes Atticus, Olympia, Greece	111
Figure 219. Two Corinthian capitals from the Temple of Deified Trajan, Pergamon	111
Figure 220. A Corinthian capital and a pilaster from the Temple of Hadrian, Ephesus	111
Figure 221. A Corinthian capital from the Celsus Library, Ephesus	112
Figure 222. A Corinthian capital and a pilaster from the Gate of Hadrian, Ephesus	112
Figure 223. A Corinthian capital from Temple N1, Side, Asia Minor	112
Figure 224. Corinthian capitals from the Imbriogon, Cilicia, Asia Minor	113
Figure 225. Two Corinthian capitals and a pilaster from Temple Tomb 1, Cilicia, Asia Minor	113
Figure 226. Corinthian capitals and a pilaster from the Temple of Baachus, Baalbek	113
Figures 227-229. Two Corinthian pilasters and a capital from the Temple of Bel, Palmyra	114
Figure 230. A Corinthian capital from the Sanctuary of Zeus, Jerash, Jordon	114
Figure 231. A Corinthian capital from the Sanctuary of Artemis, Jerash, Jordon	114
Figure 232. Corinthian semi-capitals from the Arch of Hadrian, Jerash, Jordon	114
Figure 233. A reconstruction of a Corinthian capital from Bostra	115
Figure 234. A Corinthian capital from the Thermal Basilica, Tyre, Lebanon	115
Figure 235. A Corinthian capital from the Byzantine Martyrium, Tyre, Lebanon	115
Figure 236. A Corinthian capital from the Temple of Venus, Baalbek	115
Figures 237A-B. A Corinthian capital and a pilaster from the Arch of Septimius Severus, Lepcis Magna, Lybia	117
Figure 238. Two Corinthian capitals from the Basilica of Septimius Severus, Lepcis Magna, Lybia	117
Figure 239. A Corinthian capital from the Severan Basilica, Lepcis Magna, Lybia	117
Figures 240-244. Reconstructions of Palm-Leaf capitals from Lepcis Magna (Lybia), Athens (Greece), Smyrna (Asia Minor), Pergamon and Tripolitania (Lybia)	117
Figure 245. A reconstruction of the Type I.A Free Corinthian capital from Alexandria	119
Figures 246-248. Type I.A Free Corinthian capital from Alexandria, Dandara, and Edfu (Egypt)	119
Figure 249. A reconstruction of the Type I.B Free Corinthian capital from Alexandria	119
Figures 250-251. Type I.B Free Corinthian capital from Hermopolis Magna and Alexandria (Egypt)	119

Figure 252. A reconstruction of Type I.C Free Corinthian capital from Alexandria	120
Figures 253-254. Two Type I.C Free Corinthian capital from Luxor and Alexandria (Egypt)	120
Figures 255-256. Two Type III Alexandrian Corinthian capitals from Dandara and Philae	121
Figures 257-273. Several Asiatic Corinthian capitals of different designs from Alexandria	121-124
Figures 274-276. Roman coins with representations of the Roman phase of the Alexandrian Sarapeion	125
Figure 277. A fragment of an acanthus leaf of a Corinthian capital from the site of the Alexandrian Sarapeion	126
Figure 278. The capital of the Column of Diocletian (Pompey's Pillar) at the site of the Alexandrian Sarapeion	126
Figures 279-281. Several Asiatic Corinthian capitals from the Roman Baths at Kom El-Dekka, Alexandria	127
Figure 282. An Egyptianized Type III Alexandrian Corinthian captital at Kom El-Shuqaffah Necropolis, Alexandria	127
Figure 283. Main monuments of the Roman version of the Forum of Hermopolis Magna, Egypt	128
Figures 284A/B-285. Corinthian capitals from the Forum at Hermopolis Magna, Egypt	129
Figure 286. Type I Asiatic-Based Corinthian capital, Graeco-Roman Museum, Alexandria	134
Figure 287. Type I Asiatic-Based Corinthian capital, Coptic Museum, Cairo	134
Figures 288. Type I Asiatic-Based Corinthian capital, Graeco-Roman Museum, Alexandria	135
Figure 289-290. Type I Asiatic-Based Corinthian capital, St. Mina/Abo Mina, Alexandria	135
Figures 291-292. Type II Asiatic-Based Corinthian capital, Graeco-Roman Museum, Alexandria	135
Figure 293. Type II Asiatic-Based Corinthian capital, St. Mina/Abo Mina, Alexandria	135
Figure 294. Type II Asiatic-Based Corinthian capital, Graeco-Roman Museum, Alexandria	135
Figure 295. Type II Asiatic-Based Corinthian capital, St. Mina/Abo Mina, Alexandria	135
Figure 296. Type III Asiatic-Based Corinthian capital, St. Mina/Abo Mina, Alexandria	136
Figure 297. Type III Asiatic-Based Corinthian capital, Graeco-Roman Museum, Alexandria	136
Figure 298. Type III Asiatic-Based Corinthian capital, reused at the Mosque of El-Nasser ibn Qalawon, Cairo	136
Figures 229-300. Type III Asiatic-Based Corinthian capital and lower fragment, St. Mina/Abo Mina, Alexandria	136
Figure 301. Locally produced Asiatic-Based Corinthian capital from Fayoum, Graeco-Roman Museum, Alexandria	137
Figure 302. Locally produced Asiatic-Based Corinthian capital from Bawit, Louvre Museum, Paris	137
Figures 303-305. Wide-Trapezoid Four-Leaf Capitals, Graeco-Roman Museum, Alexandria	138
Figure 306. Narrow-Trapezoid Four-Leaf Capital, Coptic Museum, Cairo	139
Figure 307. Narrow-Trapezoid Four-Leaf Capital, Qalawon Complex, Cairo	139
Figure 308. Narrow-Trapezoid Four-Leaf Capital, Graeco-Roman Museum, Alexandria	139
Figures 309-310. Narrow-Trapezoid Four-Leaf Capitals, Graeco-Roman Museum, Alexandria	139
Figure 311. Narrow-Trapezoid Four-Leaf Capital, Coptic Museum, Cairo	139

Figures 312-313. Wide-Trapezoid Four-Leaf Capitals, Graeco-Roman Museum, Alexandria	140
Figure 314. Narrow-Trapezoid Four-Leaf Capital, Wadi Natrun, Fayoum	140
Figures 315. Simplified Four-Leaf Capital from Bawit, Louvre Museum, Paris	140
Figure 316. Simplified Four-Leaf Capital from Bawit, Graeco-Roman Museum, Alexandria	140
Figure 317. Simplified Four-Leaf Capital from Saqqara, Coptic Museum, Cairo	140
Figure 318. Cylindrical-form Four-Leaf capital from Bawit, Coptic Museum, Cairo	140
Figure 319. Cylindrical-form Four-Leaf Capital, Graeco-Roman Museum, Alexandria	140
Figure 320. Cylindrical-form Four-Leaf Capital, Apa-Geremais Monastery, Saqqara	140
Figure 321. Cylindrical-form Four-Leaf Capital, Kom Obmo Basilica	141
Figure 322. Cylindrical-form Four-Leaf Capital, Apa-Geremais Monastery, Saqqara	141
Figure 323. Cylindrical-form Four-Leaf Capital, Temple of Hathor, Dandara	141
Figures 324. Alexandrian-Influenced capital, Sultan Hassan Madrasa	142
Figures 325. Alexandrian-Influenced capital, Bawit	142
Figures 326. Alexandrian-Influenced capital, Saqqara	142
Figures 327-329. Alexandrian-Influenced capital, Graeco-Roman Museum	142
Figure 330. Alexandrian-Influenced capital, Coptic Museum	142
Figures 331-334. All-Acanthus capitals from Hermopolis Magna	143
Figure 335. All-Acanthus capital, Coptic Museum, Cairo	143
Figure 336. All-Acanthus capital from Bahnasa, Graeco-Roman Museum, Alexandria	143
Figures 337-339. All-Acanthus capitals, Graeco-Roman Museum, Alexandria	143
Figure 340. Impost block from Kom El-Dikka, Alexandria	144
Figure 341. Impost capital from Mosque of El-Nasser ibn Qalawon, Cairo	144
Figure 342. Impost capital, Graeco-Roman Museum, Alexandria	144
Figure 343. Impost capital, Coptic Museum, Cairo	144
Figure 344. Basket capital, Louvre Museum, Paris	144
Figure 345. Melon capital, Coptic Museum, Cairo	144
Figure 346. Bizonal capital with Ram Heads, Graeco-Roman Museum, Alexandria	145
Figure 347. Bizonal capital with Ram Heads, Coptic Museum, Cairo	145
Figure 348. Bizonal capital with vegetal decorations, Coptic Museum, Cairo	145
Figure 349. Bizonal capitals with two Eagles, Coptic Museum, Cairo	145
Figure 350. Bizonal capital with anthropomorphic representations (Green Man), Graeco-Roman Museum, Alexandria	145

Figure 351. Palm-Leaf capital with acanthus collar, Graeco-Roman Museum, Alexandria	146
Figure 352. Simplified Palm-Leaf capital, Wadi Natrum	146
Figure 353. Palm-Leaf capital, Church of St. Sabas, Alexandria	146
Figures 354-355. Wind-Blown capital, Coptic Museum, Cairo	146
Figure 356. Interior of the White Monastery, Sohag	147
Figure 357. Stelae of Apa Shenoute, the Metropolitan Museum	147
Figure 358. Upper niche on the interior of the White Monastery, Sohag	147
Figures 359-370. Capitals and pilasters from the interior of the Red Monastery, Sohag	148-150
Figures 371-372. A Basket and a Melon capital from the Monastery of Apa Apollo in Bawit, Louvre Museum, Paris	151
Figures 373-374. Two Basket capitals from the Monastery of Apa Jeremiah in Saqqara, Coptic Museum, Cairo	151
Figures 375-376. Two Palm-Leaf capitals from the Monastery of Apa Jeremiah in Saqqara, Coptic Museum, Cairo	152
Figures 377. An Asiatic-Based Corinthian capital from the garden of Hagia Sophia, Constantinople	155
Figure 378. A reconstruction of the Asiatic-Based Corinthian capital of the Column of Marcian, Constantinople	155
Figure 379. The Asiatic-Based Corinthian capital of the Column of Aelia Eudoxia, Constantinople	155
Figure 380. An Asiatic-Based Corinthian capital from the Church of Theotokos Kyriotissa, Constantinople	156
Figure 381. An Asiatic-Based Corinthian capital from Basilica A, Macedonia, Greece	156
Figure 382. An Asiatic-Based Corinthian capital from the so-called Sultan Cistern, Constantinople	156
Figure 383. Four-Leaf capital from the garden of Hagia Sophia, Constantinople	157
Figure 384. Four-Leaf capital from the Basilica Sant'Apollinare Nuovo, Ravenna, Italy	157
Figure 385. Four-Leaf capital from the Basilica of St. Demetrius, Thessaloniki, Greece	157
Figure 386. A Wind-Blown capital from Antioch	158
Figures 387-388. Two Wind-Blown capitals from Thessaloniki	158
Figure 389. A Wind-Blown capital from Classe, Ravenna	158
Figure 390. An Impost capital from Alexandria	159
Figure 391. An Impost capital from Ravenna	159
Figures 392-394. Impost capitals and blocks from the Basilica of St. Vitale, Ravenna	159
Figures 395-396. Two Basket capitals from Hagia Sophia, Constantinople	160
Figure 397. A Basket capital from Basilica B, Philippi, Greece	160
Figure 398-399. Two Melon capitals from Hagia Sophia, Constantinople	161
Figure 400. A Melon capital from the Church of Theotokos Kyriotissa, Constantinople	161
Figure 401. A Melon capital from Little Hagia Sophia, Constantinople	161

Figure 402. A Melon capital from the Basilica of St. Vitale, Ravenna 161

Figure 403. A reconstruction of a Four-Leaf capital from Suvodol, Serbia..... 161

Figure 404. A reconstruction of a Four-Leaf capital from the Cruciform Church, Caricin Grad, Serbia 161

Figure 405. A reconstruction of a Four-Leaf capital from the Domed Church in Konjuh, Republic of North Macedonia ... 161

Figure 406. A reconstruction of a Bizonal capital with bird figures from Hagia Sophia, Constantinople 162

Figure 407. A reconstruction of a Bizonal capital with Pegasus figures, Hippodrome of Constantinople 162

Figure 408. A Bizonal capital with anthropomorphic representations (Green Man), Istanbul Archaeology Museum 162

Figure 409. A Bizonal capital with ram heads, Church of St. Demetrius, Thessaloniki 162

Figures 410-412. Three Bizonal capitals with eagle representations, Thessaloniki..... 163

Figure 413. A Bizonal capital with Griffin representations at the Euphrasian Basilica in Poreč, Croatia 163

Figure 414. A Type IV Alexandrian Corinthian pilaster from the Basilica of St. Vitale, Ravenna 163

Figure 415. A Type I Alexandrian Corinthian pilaster, Basilica A, Philippi, Greece 163

Figure 416. Alexandrian-Based Corinthian pilaster, Myrelion Church, Constantinople 163

Figures 417-419. Three Alexandrian-Based Corinthian pilasters, Basilica of Bishop Philip, Stobi, Republic of North Macedonia 164

Figure 420. A Palm-Leaf capital from the Basilica of St. Demetrius, Thessaloniki 164

Appendices: Maps.....<https://doi.org/10.32028/9781803272399-maps>



Appendices: Catalogue.....<https://doi.org/10.32028/9781803272399-catalogue>



Preface

The Corinthian capital design is one of the most decorative capitals in the history of architecture. Monuments spanning from the Classical period until modern day are decorated with these elegant capitals. They are still being used for both interior and exterior decorations, for public buildings and private residences. For more than a century, researchers were convinced – some of them still do – that since it was originated in Greece, it also evolved in Greece and spread into the Roman provinces.

The evolution of the Corinthian capital had taken many forms across the centuries. Each territory or kingdom had adapted certain models, which were suitable to their architectural taste. It is assumable that in the modern day, it is the canonical design from the early decades of the Roman Empire that is still being used worldwide.

The aims of this study are:

- Highlighting the Classical versions of the Corinthian capitals that were adapted in the Hellenistic period.
- Tracing the rise and evolution of the Corinthian capitals through Antiquity (the Classical, Hellenistic, Roman and Late Roman/Byzantine periods) in comparison to the Alexandrian versions of the Corinthian capital.
- How the Alexandrian capital, with its four Hellenistic types, played the prototypical role as a main influence; to be the base of the canonical Roman Orthodox capitals, and Late Roman/Byzantine capitals.
- The influence of the Alexandrian capitals on other Hellenistic territories.
- Raising the “Atiochean Question” about the origin of the Olympeion, its Hellenistic source of influence, and how it was mistakenly praised as the prototype for the capitals of the Roman Capitolium's third phase.
- Raising the “Regillian Question” and the relation between the Late Republican period (Sanctuary of the Great Gods), its conquests in the Eastern Mediterranean, and how Samothrace's Arsinoeion influenced the canonization of the Roman Orthodox Corinthian capital.
- The continuation of the usage of the Alexandrian models throughout Egypt during the Roman Imperial period, paralleling the Roman Orthodox and later Asiatic capital designs.
- The Early Byzantine period and how Alexandria (presented through the discoveries across Egypt) had an indirect influence in presenting several designs of the Corinthian and Corinthianized capitals across the Byzantine territories until the Arab Conquest and the fall of Egypt in AD 641.

This study will focus thoroughly on analyzing several examples of the Corinthian capitals at hand with a very accurate description of its motifs. Central helices, corner volutes, acanthus collars, fleuron, calyces, cauliculi and abacus will be the focus of this study. Each element will be analyzed regarding its proportions to the capital, design, origin of design and influences.

Ratios provided by Vitruvius and the analysis provided by Jones will be the cornerstone for basing the analysis and comparisons. Most capital at hand will be put on comparison with other examples and with the Vitruvian canon regarding the Corinthian capital. Also, studies provided by Pensabene in 1993, McKenzie in 2007 and Tkaczow in 2010 will efficiently support this comparative study, as references to the architectural discoveries in Alexandria and Egypt.

Previous Studies

The following references had discussed the Corinthian capital through different eras, locations/sites and aspects, each from their own perspective(s). However, each reference had tackled the Corinthian order partially. Almost all references had focused on the same Classical Corinthian capitals examples. Also, it

appears that most references had neglected the presence of a Hellenistic Alexandrian style. Mainland Greece and Asia Minor were the main focus for their examples regarding the Hellenistic architecture.

Sir Fletcher's *A History of Architecture* (1905) was among the very first to give examples; unfortunately, they were very basic. However, these examples were detailed in analyzing the capitals. Robertson's *A Handbook of Greek & Roman Architecture* (1929) had discussed examples of the Corinthian capitals in Greece, Asia Minor and Southern Italy, while focusing on the Athenian temple of Olympian Zeus. Fyfe's *Hellenistic Architecture* (1936) was probably the first to discuss Hellenistic monuments outside the Hellenic domain of Greece and Asia Minor. However, his focus was on Levantine coast. Dinsmoor's *Ancient Greece* (1950) had discussed examples similar to those already discussed by Robertson, with focus on the Athenian temple of Olympian Zeus. Lawrence's *Greek Architecture* (1996) was no different from Dinsmoor and Robertson regarding Hellenistic examples from Greece and Asia Minor.

As a result, the previous references had thoroughly given almost the same examples regarding the Classical Corinthian capital; however, very few details about the Hellenistic period, with focus on Mainland Greece and Asia Minor. The only common point of discussion is that these references had acknowledged the relation between the Athenian temple of Olympian Zeus and its effect on the architecture of the Roman temple of Jupiter Capitolinus as a Hellenistic element and its effect and spread through the Roman Imperial Period – a theory that was and still common among scholars, although Siwicki's *Architectural Restoration and Heritage in Imperial Rome* (2020) had refuted the theory entirely, which shall be discussed in details in Chapter II. Therefore, this is the first missing link between the Classical and Hellenistic Corinthian capitals in terms of Alexandria and its influence over the Athenian Temple of Olympian Zeus, which will lead to the second link regarding Roman architecture in the following chapters.

Winter's *Studies in Hellenistic Architecture* (2005), the 11th chapter 'From Greek Structure to Roman Ornament: The Columnar Order in Hellenistic Times' was the only proper reference that traced the evolution of the Classical Corinthian capitals to Hellenistic Corinthian capitals in regards to the Seleucid and Ptolemaic kingdoms, as well as mentioning the importance and influence of the Alexandrian architecture. However, Winter's study of Classical examples was just a surface-level study and was not detailed.

Judith McKenzie, through her two books, played one of the most important roles regarding the study of Alexandrian Hellenistic architecture. McKenzie's *The Architecture of Alexandria and Egypt* (2007) is probably the main of two references in this study, along with Pensabene's (1993). This book forms a link with the previous sources on Classical architecture and how it affected Alexandrian Hellenistic architecture. Although McKenzie discusses the Corinthian capital across the Hellenistic, Roman and Late Roman period, the connection is not very focused, with few examples regarding Late Roman capitals and fewer regarding Roman capitals. McKenzie's *Architecture of Petra* (1990) played the missing link between Nabataean and Pompeian architecture, with Alexandria as a source of Influence. Via this study, we could trace the influence of Alexandrian Hellenistic architectural presence in Pompeii prior to the Roman Annexation of Egypt.

The two books of Barbara Tkaczow: *The Topography of Ancient Alexandria* (1993) and *Architectural Styles of Ancient Alexandria: Elements of Architectural Decorations from Polish Excavations at Kom El-Dikka* (2010) will be base for examples regarding the three periods of Ancient Alexandria.

Roman architecture researchers seem to focus on Etruscan and Italo-Hellenistic architecture starting from the examples in Magna Graecia and jump directly to the temple of Jupiter Capitolinus as the new source of influence, without mentioning the evolution of the Hellenistic Corinthian capital. MacDonald's *The Architecture of the Roman Empire* (1982) focuses on the imperial architecture, mainly the Parthenon and Hadrian's contributions. Sear's *Roman Architecture* (1982) and its newly published second edition (2021) conclude the beginning of the Corinthian influence from the Late Republic period and onto the example of Jupiter Caitolinus with a hint referring back to the Athenian Temple of Olympian Zeus. Stamper's *The Architecture of Roman Temples* (2005) seems to be focusing more in Imperial Architecture and the rise of the Orthodox capital without a reference to the origin rather than a hint to the Olympian Zeus temple. Stamper's

article in *A Companion of Roman Architecture* traces and focuses on the rise of the Roman Orthodox Corinthian capital.

It seems that few researchers had studied the Italo-Hellenistic Corinthian capitals and its influence over Roman architecture, along that of the Capitoline/Olympian capital. Even when it comes to the latter example, they seem to use the Capitoline capital as a cornerstone without referring to its origins and evolution.

Coptic capital evidences from all over Egypt will be put to comparison. Gabra's *Coptic Monasteries* (2002) is a guideline study for Coptic churches and monasteries across Egypt. Meinardus, *Two Thousand Years of Coptic Christianity* (2002) is another guideline mentioning some churches and capitals with reference to Corinthian capitals.

Jackson's *Byzantine & Romanesque Architecture*, Vol. 1 & 2 (1975) and McKenzie's *Architecture of Alexandria* (2007) show examples of capitals from Constantinople and various cities across Europe under Byzantine influence respectively. However, none traces the origins of the capitals, except for McKenzie and on a surface level – when it comes to Late Roman capitals.

As for the third chapter, the problem with Byzantine monuments is an artistic problem. Due to the nature of Christianity and its main impose over the Roman Empire, the focus shifted on Christian figures and iconography more than and rather than its architectural marvel. The importance of columnar orders – as a study – has reduced, although the artistic representations did not whither or reduce. Capitals had improved and new sub-orders emerged (i.e. basket and imposed). It is the problem of researchers that they neglected studying such architectural elements.

Also, one of the most important books is Pensabene's "Reportorio d'arte dell'Egitto Graeco-Romano." *Elementi architettonici di Alessandria e di altri siti egiziani*. Serie C: 3 (1993). Although being almost 30 years old to our date, this book and its catalogue hosts one of the largest numbers of architectural fragments unearthed in Alexandria and Egypt. It is considered essential to this study, where it would be very difficult to trace the Corinthian capital evolution in Egypt if not for it.

Introduction

The Rise of the Corinthian Order in Classical Greece

In order to discuss the evolution of the Corinthian capitals in Hellenistic Alexandria and how its influence had spread across the Mediterranean for nearly 10 centuries and beyond, it is best to recall the earliest Classical models. These Classical models were either abandoned, or altered regarding their designs, or adapted into the Hellenistic period. It is important to highlight which models were taken into consideration, which motifs were blindly adapted and which were changed across the centuries.

The Story behind the Creation of the Corinthian Capital

The Corinthian order is one of the three Classical orders that emerged in Ancient Greece. It is described as the most decorative of the three Classical orders. Vitruvius describes the Corinthian order only as a capital order, since the columns and bases used for this capital order are Ionic, along with the entablature which could either be Doric or Ionic, at least during its earlier forms.

The description on the prototypical Corinthian capital, according to Vitruvius, is firstly based on the story of the death of a Corinthian young maiden. The maiden's nurse gathered her favorite objects in a basket and placed them, accidentally, over an acanthus plant root. The artist and bronze sculptor Callimachus of Corinth had witnessed the maiden's grave, which by then the acanthus plant had grown over the basket "and in the course of its growth reached the angles of the tile, and thus formed volutes at its extremities."¹ This had inspired Callimachus to design the first model of the Corinthian capital.

Architecturally speaking, the Corinthian capital consists mainly of a "deep bell", a double collar of acanthus leaves, eight leaves for each side, two corner volutes and two small, interior, central helices; the abacus as a common element of all capitals, and both the cauliculi and calyces, which were found in few cases, are presented in eight, a pair on "ribbed sheath", each of the four sides of the capital.²

Vitruvius gives the measurements of the prototypical Corinthian capital, which shall be the base of measurement for the evolution of the upcoming versions of the Corinthian capitals through Antiquity – see p. 14. For Vitruvius, the acanthus leaf's height "is to be equal to the diameter of the lower part of the column." The width of the abacus is twice its height and its shape is diagonal. The four sides of the abacus are to be extremely carved inwards. The necking's diameter is to be equal to that of the column.³

The earliest appearance of the Corinthian order is uncertain among scholars. However, they shall be divided according to their singular and multiple appearances, on the interior, as well as one case on the exterior.

Classical Corinthian Temples and Monuments

The first or earliest appearance ever mentioned was inside the naos of the Temple of Apollo Epicurius in Bassae, Arcadia, built in the 430–429 BC.⁴ Although the interior of the temple was of the Ionic order, there stood at the end of the naos, at the southern end, a singular column with a single Corinthian capital.⁵

¹ Vitruv, *De Archit.* Book IV, Intro., par. 1, 9 & 10.

² Vitruv, *De Archit.* Book IV, Intro., par. 11; Fletcher 1905: 26.

³ Vitruv, *De Archit.* Book IV, Intro., par. 11.

⁴ Fletcher 1905: 87; Dinsmoor 1950: 154, note 2; Robertson 1929: 136.

⁵ Fletcher 1905: 75; Boardman 1989: 126.

The Bassae's capital (Figure 1) is described as "an isolated, extraordinary example," According to Dinsmoor, at the south of the naos. It had small corner volutes at each corner with flat spirals supporting the abacus, and a double collar of acanthus leaves under it. Each side has a set of eight acanthus leaves, divided upon two rows – twenty tiny leaves in total.⁶ The acanthus leaves, however, were low, exposing part of the bell, which was covered with painted leaves.⁷ Robertson assumes the leaves by the angles to be "water-lily leaves;" a note worth considering, since water plants tend to appear in further Corinthian developments.⁸



Figure 1. A reconstruction of the Corinthian capital from Bassae (Dinsmoor)

There are four pairs of cauliculi, emerging out and over the acanthus leaves, two on each side. Each cauliculus has an inner, large volute that springs outwards, commonly known as the inner helix, with plain stems. The floral decoration, a palmette, is found beneath the abacus, "wholly in the bell", right in the middle and above the inner helices, with a small stem below the leaves. The abacus is sharply concave,⁹ with meander painting on it.

The second appearance of the Corinthian capital comes about 100 years after that at Bassae. It appeared in multiple repeats, rather than a single capital. The appearance happened in three places contemporarily to one another in the 4th century BC; the capitals from the Athenian Monument of Lysicrates, the Tholos of Delphi and the Tholos of Epidauros.

The Monument of Lysicrates at Athens is a circular monument dedicated to Lysicrates c. 335-4 BC,¹⁰ who won a choral contest. Although not typically a tholos, it shows further development of the Corinthian capital.¹¹ The monument is surrounded by six projecting columns crowned with Corinthian capitals.¹² The appearance of the Corinthian capital (Figure 2) at the Monument of Lysicrates is rather interesting. Unlike the temple of Apollo at Bassae, which was single and on its interior, the Corinthian capitals of the Monument of Lysicrates are six in number, on the exterior¹³. The exterior usage of Corinthian capitals on round building will not appear again until the Late Roman Republican Period.¹⁴



Figure 2. A reconstruction of a Corinthian capital from the Lysicrates Monument (Dinsmoor)

There are also changes not only in the location of the capitals, but also in the design itself. The capitals are half-shaped, resembling the ones adapted later at the Hellenistic Temple of Apollo Dydimaeus.¹⁵ The double collar of acanthus leaves still existed; however, the upper row was elevated than the lower one, showing taller leaves. The cauliculi are presented in a more rich and extravagant manner.¹⁶ Between the acanthus leaves of the upper row are "flowers like poppies" embedded between the acanthi. The leaves of the lower row are "rush-like, long and slender, and curved over the tip;" a feature what would appear as a Late Greek ornament. These leaves are placed instead of acanthi at

⁶ Dinsmoor 1950: 158.

⁷ Robertson 1929: 140.

⁸ See p. 33-4.

⁹ Fletchers 1905: 85; Robertson 1929: 140; Dinsmoor 1950: 158; Lawrence 1983: 135; Boardman 1989: 126, 127; Chitham 2005: 34; McKenzie 2007: 84.

¹⁰ Dinsmoor 1950: 237; Richter 1982: 41.

¹¹ Fletcher 1905: 87; Richter 1982: 41; Lawrence 1983: 140.

¹² Fletcher 1905: 87 – 88; Robertson 1929: 144; Lawrence 1983: 140.

¹³ Dinsmoor 1950: 237.

¹⁴ See the Round Temple by the Tiber in Chapter II, p. 75-76.

¹⁵ Fletcher 1905: 88; see p. 19.

¹⁶ Chitham 2005: 34.

the lower row.¹⁷ Another interpretation of the poppies and lower row, a water plant, as mentioned by Dinsmoor, of the collar of being "a lower row of sixteen lotus leaves" and the upper acanthus one is decorated with an "eight-petalled flower resembling an Egyptian lotus" between each two acanthi leaves.¹⁸

The Tholos of Delphi at the Sanctuary of Athena Pronaia was built between 390–380 BC. The tholos, currently at the ruins of Marmaria, was decorated with ten "Corinthian half-columns" on its interior wall.¹⁹ The outer columns were Doric, assuming that although presented in multiple numbers, the Corinthian capitals were treated as an interior form of decoration in Delphi.

Based on the sketch provided by McKenzie, the capital (Figure 3) is decorated with double row of small acanthus leaves surrounds the lower part of the capital. Corner volutes extend inwards, forming back-to-back inner helices.²⁰ The leaves of the collar are sometimes acanthus, other times, a water plant; of a "rotary or wind-blown motion". The central helices do not emerge from the acanthus collar; however, they are connected with the corner volutes in S-shaped scrolls, known as "lyre patterns."²¹

We could state that the Corinthian capital from the Tholos of Delphi had developed from an earlier capital from Olympia (Figure 4), which has two corner volutes coiling inwards into interior, back-to-back helix, topped with a palmette. However, this capital has no acanthus collar. The same Olympian capital will affect early Hellenistic capital designs in Egypt, Nabataea and Southern Italy.²² This is due to the inclination of the volute stems – unlike the capital from Delphi that has almost straight stems – and the absence of the acanthus collar; both are features of the Type IV Alexandrian Corinthian capital.²³

Concerning the central fleuron, Chitham believes that the capitals of the Monument of Lysicrates were the first to introduce the palmette at the center of the abacus. However, presented sketches²⁴ about the Temple of Bassae (Figure 1) shows the existence of a plant-like ornament, typically a palmette, above the helices and directly beneath the abacus. The palmette was also introduced at the capital of the Tholos of Delphi.²⁵ However, the Tholos of Epidauros²⁶ had a rosette placed instead of the palmette.²⁷

The Temple of Athena Alea at Tegea (Figure 5), built in the second quarter of the 4th century BC, 345–335 BC, by Skopas the sculptor.²⁸ The naos of the temple was surrounded by fourteen half Corinthian columns on the



Figure 3. A reconstruction of a Corinthian capital from the Tholos of Delphi (McKenzie)



Figure 4. A reconstruction of a Corinthian capital from the Tholos at Olympia (McKenzie)

¹⁷ Lawrence 1983: 140.

¹⁸ Fletcher 1905: 88; Dinsmoor 1950: 238.

¹⁹ Robertson 1929: 141–142; Petras 1981: 22–23.

²⁰ McKenzie 2007: 84.

²¹ Dinsmoor 1950: 234.

²² McKenzie 2007: 84, 86.

²³ See Type IV of the Alexandrian Corinthian capitals, p. 38–40.

²⁴ Sketches are attributed to Karl Haller von Hallerstein; see Chitham 2005: 34.

²⁵ Cockerell 1860: pl. XV (under Phigaleia); Dinsmoor 1950: 211 – 212, Figures 8 & 9; Chitham 2005: 34; Winter 2006: 223.

²⁶ See next page.

²⁷ Lawrence 1983: 140.

²⁸ Robertson 1929: 143; Lawrence 1983: 144; Norman 1984: 169 – 170, 170 footnote 3.

According to Pausanias, the temple is referred to as temple number 3, built by the great sculptor Skopas, to be distinguished from the two prior temple; an Iron age temple and an Archaic temple (395 BC).

lower level and half Ionic columns on the upper floor.²⁹ Same positioning and closely related capitals were found at the Temple of Nemean Zeus³⁰ (Figure 6) and the temple at Bassae (Figure 1), but with replacing Ionic with Corinthian capitals. The usage of Corinthian capitals could perhaps be an early development of the interior decoration and appearance for the Corinthian temple on the inner naos of temple; a development of the example from Bassae.

Regarding the capital at Tegea (Figure 5), it is described as "a rich, lush example of the Corinthian order." The base of the capital was decorated by a double collar of "shaggy" acanthus leaves; six leaves per row. Two cauliculi emerge from the acanthus collar as the two corner volutes spring out from the cauliculi, according to the reconstruction provided. This was the first appearance for the cauliculi.³¹ Interestingly, the corner volutes are decorated with an acanthus leaf each.³² Moreover, it shows the replacement of the central helices and the fleuron or palmette by another central acanthus leaf, extending upwards towards the abacus, decorating the bell, above the central leaf from the upper row of the collar.³³ The leaves of the cauliculi are bent, probably in resemblance of the removed helices. Same description is applicable to the capital from the Temple of Zeus at Nemea.



Figure 5. (left) A reconstruction of a Corinthian capital from the Temple of Athena Alea (Piet de Jong)



Figure 6. (right) A reconstruction of a Corinthian capital from the Temple of Zeus Nemea (Miller)

The final example, which is a contemporary of the Monument of Lysicrates is the Tholos of Epidauros, built in c. 340 BC. It is described as a circular, marble-made, roundhouse near the temple of Asclepius. The design of the tholos is to be surrounded, on the external, by Doric columns and "slim Corinthian columns engaged on the interior walls"³⁴; fourteen fully erected Corinthian columns on the interior, unlike the half columns at the Tholos of Delphi.³⁵ It is a typical Corinthian capital with "two tiers of acanthus", surmounted by "fully developed" volutes.³⁶

The so-called Epidauran capital (Figure 7) is different from the previous examples, since the helices emerge directly from the acanthus collar, rather than from the cauliculus.³⁷ "The helices and corner volutes spring

²⁹ Robertson 1929: 144; Norman 1984: 176.

³⁰ Lawrence 1983: 144.

³¹ Dinsmoor 1950: 219; the capital is originally described by Dugas and Clemmensen, while the reconstruction is attributed to Piet de Jong.

³² Robertson 1929: 144.

³³ Robertson 1929: 144; Lawrence 1983: 144; Norman 1984: 177.

³⁴ Boardman 1989: 138.

³⁵ Robertson 1929: 144; Dinsmoor 1933: 235; description is provided by the authors, based on that of Pausanias.

³⁶ Chitham 2005: 34.

³⁷ McKenzie 2007: 84 – 85.

together from the one leaf which is wrapped around them."³⁸ This feature will be known in Hellenistic Syria and Egypt.³⁹

However, other characteristics remain the same, like the double acanthus leaves. The fleuron is neither resting on the central helices nor on the abacus. It hangs from the lowest lip of the abacus, suspended above the helices.

What is more special about this capital is that it shall play a great role in Hellenistic Alexandria, adapted, labeled as Type I of the Alexandrian Corinthian capitals – for example, El Khartoum Column's capital in Alexandria⁴⁰ – and result in the development of the other three types, which will be thoroughly discussed in the next section – see the first three types of the Alexandrian Corinthian capitals in Chapter I.

One additional example, which is considered to be the closest of the previous ones to the Hellenistic Age, is the Philippeion in Olympia. It was built by Philip II, king of Macedonia, in 339 BC and finished by his son, Alexander the Great. The tholos-like building was decorated with nine semi-detached Corinthian columns on the interior.⁴¹ The naos of the building was housing five statues of the house of Philip, including his and Alexander's.

The capital of the Philippeum (Figure 8) resembles that from Tegea. The central helices are removed, as well as the central fleuron, and replaced by an acanthus leaves. Cauliculi emerge from the acanthus collar and corner volutes spring out of them. The only two differences are the proportions, being higher, like the capitals from the Temple of Apollo at Bassae, and "the small leaves round the bare upper part of the bell... according to Pausanias, held together at the top by a bronze poppy, which formed a central finial".⁴² The rest of the capital is carved with "tall, upright" leaves to resemble the painted leaves from the Temple of Apollo at Bassae.⁴³ Similar examples will appear in Nabataea and at the Temple of Augustus in Philae, where the exposed part of the kalathos is either decorated with carved floral motifs or painted motifs, respectively – see the Nabataean Kingdom in Chapter I, p. 52ff, and Augustan Egypt in Chapter II, p. 97ff.

The Vitruvian Proportions

Moreover, the proportions (ratios) presented by Vitruvius⁴⁴ are worth considering. However, studying these proportions requires both an analytical study and accurate statistical measurements of the proportions of each capital. A similar mathematically statistical and analytical study was applied by Mark W. Jones regarding the "Designing of the Roman Corinthian Capital."⁴⁵

Although Jones' study will be essential for this research, especially in the second chapter regarding Roman capitals, this statistical study will not be the focus of this research, but rather as a supporting theory for the evolution of the Corinthian capital. Therefore, comparisons amongst proportions will be applied regarding

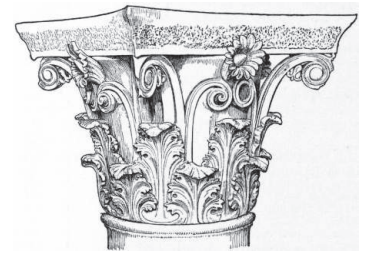

Figure 7. A reconstruction of the Corinthian capital from the Tholos of Epidauros (Wikimedia)

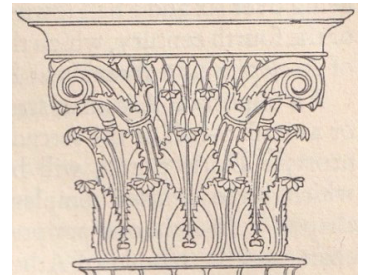

Figure 8. A reconstruction of the Corinthian capital from the Philippeum (Robertson)

³⁸ McKenzie 2007: 85.

³⁹ Robertson 1929: 144.

⁴⁰ Ronczewski 1927: 5; see p. 30, Figure 22.

⁴¹ Dinsmoor 1950: 236.

⁴² Dinsmoor 1950: 236.

⁴³ Robertson 1933: 144–145.

⁴⁴ Vitruv., *De Archit.* Book IV, Intro., par. 11-12.

⁴⁵ Jones 1991: 89–150.

only the following elements discussed by Jones: height of capital, height of abacus, height of kalathos/bell, diameter/height of fleuron and height of leaf range.

The other remaining analytical details of Jones' study require more depth that needs direct access to each capital at sites or museums, as well as funds for travelling to such sites, or even permissions for the storehouses of Museums, or more, by examining the examples from the Graeco-Roman Museum, which is still at this time being under reconstruction; all previous propositions are, unfortunately, unavailable. Therefore, only the following proportions must be taken into consideration.

The suggested Vitruvian proportions⁴⁶

- Height of abacus = diameter of fleuron = $1/7$ h. of the capital.
- Height of kalathos = $6/7$ h. of the capital.
- Height of leaf range = $2/3$ of h. of kalathos.
- Relative height of leaf range = $1/3$ of h. of kalathos.
- $1/3$ of the h. of kalathos is dedicated to volutes and helices.

The Artistic Classifications of both Mainland Greek and Anatolian designs of the Corinthian Capitals

Moreover, another analytical method – rather artistic than being mathematical – presented by Herbert Abramson,⁴⁷ is also a supporting theory about differentiating between the Hellenistic capitals – either Mainland Greek or Anatolian. This theory reflects the elements which were used, omitted, adapted or modified, according to period and/or location, as follows:

Mainland Type of Corinthian Capitals

- Most Mainland Greek Corinthian capital elements/features are presented through the Classical capital of Bassae (Figures 1, 2 7, 8).
- A double collar of acanthus leaves (Figures 2, 3, 7, 8).
- The lower row leaves are carved in S-shape (Figures 1, 3, 8).
- The double collar from the Bassae's prototype covered one third ($1/3$) of the capital (Figures 1, 3); however, the Epidauran tended to cover half ($1/2$) of the capital (Figures 2, 7, 8).
- Each acanthus leaf consists of six leaflets/sections (Figures 2, 7).
- Each leaflet/section consists of five triangular, teeth-like leaves (Figure 2) – excluding the Epidauran's three-leaf sections (Figures 7, 8).
- The lowest teeth-like leaf of a section overlaps the top teeth-like leaf of the section below it; thus forming a small almond-like or bud-like sinus (Figures 2, 3) – excluding the large Epidauran sinuses (Figure 7).
- The stems of the helices and volutes emerge side by side (Figures 1, 2, 7).
- The stems of the corner volutes are deeply carved inwards (concaved) (Figures 1, 2, 7).
- The volutes coil inwards, forming a flattened-like spiral surface (Figures 3, 4).
- Central helices are of average or large in size (Figures 1, 2, 3, 4, 7).
- No cauliculi were presented – although the first cauliculi presented were from the Monument of Lysicrates at Athens (Figure 2) and the Temple of Athena Alea at Tegea (Figure 5) (both c. 335 BC), and the calyx from the latter example.

Anatolian Type of Corinthian Capitals

- A double collar of acanthus leaves, where the lower row leaves do not form the S-shaped leaves from Mainland (Figures 5, 6).

⁴⁶ Vitruv., *De Archit.* Book IV, Intro., par. 11 & 12; Jones 1991: 89.

⁴⁷ Abramson 1974: 5–8.

- The double acanthus collar and the cauliculi totally cover 1/2 of the capital (Figures 5, 6 8).
- Each acanthus leaf consists of four leaflets/sections (Figures 5, 6).
- Each section consists of three triangular teeth-like leaves (fleur-de-lis pattern) – an Epidauran feature (Figures 5, 6, 8).
- The lowest and highest teeth-like leaves overlap like the Mainland type; however, they form a large sinus – an Epidauran feature (Figures 5, 6, 8).
- The stems of the corner volutes overlap those of the central helices (Figures 2, 7).
- The stems of the corner volutes are also carved inwards, but not as deep as the Mainland type (Figures 5, 6, 8).
- Helices are small and thin in size (Figure 7).
- Helices emerge from the fluted cauliculi towards the lower tip of the abacus (Figures 5, 6, 8).
- Corner volutes coil outwards like a spiral lobe (Figures 5, 6, 7, 8).
- Adaptation of the cauliculi and calyces from the Classical examples of Athens (Figure 2) and Tegea (Figure 5); Mainland Greek feature.

Therefore, after discussing the early Classical examples of the Corinthian capitals from both Mainland Greece and Anatolia, the following will be about tackling their developments, starting with Alexander the Great's reign. We can conclude that the previously mentioned types of capitals fall under the concept of free capitals, where the artists were not bound by a certain prototype. It was these very artists that created the prototypes for the following centuries. However, their contribution will be reduced to almost nothing, compared to what is to follow, produced and adapted from Hellenistic Alexandria. The influence of Hellenistic Alexandria will take over the Mediterranean throughout the Hellenistic, Roman and Byzantine periods. Even cities that did not fall under Hellenistic kings will be affected by the Alexandrian models, resulting in the abandoning of the Classical Corinthian free capitals and favoring the Alexandrian Hellenistic ones.

Chapter I

The Creation of the Alexandrian Corinthian Capital in Context of Hellenistic Architecture

Introduction

In order for one to understand the concept behind the development of the Corinthian capitals within the Hellenistic Period, it is essential to understand the initial adaptation of the Classical capitals, the evolution underwent by these capitals and the external cultural factors of the surrounding environments.

The Hellenistic Corinthian capital had undergone three stages of evolution within the Hellenistic Period. Each stage reflects different perspectives and certain elements of the capital regarding size, shape, and proportions. It is suitable to divide them as follows, in order to facilitate the tracing of the Corinthian capital development within the Hellenistic Period:

- i. The development of the Corinthian capital within the Hellenic domain (Mainland Greece and Asia Minor).
- ii. The adaptation of the Classical Epidauran and Double-Volute models in Alexandria, specifically, and in Egypt, generally, leading to the rise of the four types of Alexandrian capitals.
- iii. The impact of the Alexandrian Hellenistic capitals over the architecture of the Hellenistic Kingdoms of the East (the Levantine Coast under the Seleucid Kingdom, the Nabataean Kingdom, and the Greek Kingdoms of Central Asia) and/or the development of their own version of the Corinthian capitals.
- iv. The originality of the development of the Corinthian capitals in the city of Alexandria and how it differs and/or influences the rest of the Ptolemaic domain and other Hellenistic regions.

Based on the introduction regarding the Classical Corinthian capitals, the Vitruvian proportions, and the classifications of capitals from both Mainland Greece and Anatolia, it was the Epidauran capital, and the Double Volute capital in certain examples, that were adapted, modified and underwent developments during the Hellenistic Period. The Epidauran capital became the first prototype for the Corinthian capitals for nearly the following ten centuries, regarding the period covered in this study.

This study does not focus on every Hellenistic Kingdom. However, mentioning these regions reflect the mentality of the artist and how it differed from both the Alexandrian and the Egyptian one. Unfortunately, examples at hand are few; however sufficient for a brief understanding of the Hellenistic Corinthian capital. Moreover, one must take into consideration the important role of the city of Athens in the future development of the Corinthian architecture. From a geographical perspective, Athens had served as a so-called neutral territory outside the domain of the Hellenistic kings. Their contributions, also in other Hellenic regions, is considered symbolic and a display of power. Although only one example is adapted from Athens, its role is quite critical and sufficient.

Corinthian Capitals of the Hellenistic World (Excluding Egypt)

Regarding the examples of Corinthian capitals from the Hellenistic domain, they mostly succeed the date of the rise of Alexandria under its first kings. However, one must study these examples and how they adapted the Epidauran capital, before proceeding into studying the Alexandrian capitals and how they influenced the Athenian Temple of Zeus Olympius from an Alexandrian perspective.

This section will discuss three main building types across the Hellenistic world: temples, tombs and monuments. Although some temples/monuments share the same territory, they shall be divided as

mentioned accordingly, as well as chronologically. Their chronological order might help revealing the evolutions and/or differences within each Hellenistic Corinthian Capital.

Temples in Asia Minor and Mainland Greece

Temple of Apollo, Didyma

The *Didymaion* near Miletus in Asia Minor could be considered the earliest Hellenistic temple constructed, since it was built in the time of or by Alexander the Great himself. It was built on the site of a previous temple in 333 BC. The Corinthian capitals of the *Didymaion* were not of free-standing columns, but rather pilasters; a pair at the back doors of the 'intermediate room, facing the steps.⁷⁴⁸ There were nine pilasters on each side of the inner *naos*;⁴⁹ hence three doors on each side.



Figure 9. A sketch of the Corinthian capital of the Temple of Apollo Didyma (Dinsmoor)

The description of the capital (Figure 9) is that the central helices are coiling inwards, facing each other, wrapped with and emerging from the cauliculi and lifting up the fleuron, presented in the shape of a palmette. The cauliculi and the emerging central helices are too small, revealing much of the surface of the kalathos. Moreover, the stem both the cauliculi and central helices are curved inwards and seem to be somehow 'undeveloped.'⁵⁰

Based on Abramson's description of the Anatolian Corinthian type, the lower half of the capital is completely covered with a double row of acanthus leaves. The sections of the acanthus leaves; however, abide to the Mainland style of the quadruple rather than the triple leaflet patterns of Anatolia. The corner volutes overlap the stem of the helices, which is wrapped in cauliculi. Both the cauliculi and calyces are small; undeveloped. Corner volutes are coiling outwards, in opposite direction of the kalathos, and their stems are carved inwards.

Based on Jones' calculations, the height of the capital = c. 1.76m, and the height of the acanthus collar = c. 0.94m, at c. 0.47% as height of leaf range.⁵¹ Therefore, the double collar of acanthus leaves is close to, but less than, the average height, covering almost half (1/2) the capital.

This temple and its capitals did not get the enough or detailed analysis, even described as being an unsuccessful attempt of executing a Corinthian capital.⁵² On the contrary, the architects seem to be affected by, if not they being Alexandrian architects.⁵³ Therefore, we could consider this design of capitals as yet an incomplete representation and an initial step towards the creation of the Normal Corinthian capital.

Temple of Zeus Olbius, Diocaesarea

Another early Hellenistic temple lies in the ancient city of Diocaesarea in Cilicia, Asia Minor. It was constructed between 306–281 BC at the order of Seleucus I Nicator, the founder of the Seleucid Empire.⁵⁴ However, some researchers attribute it to Antiochus IV Epiphanes, due to his religious propaganda and his grand contribution in the construction of temples;⁵⁵ a more convincing theory regarding the latter king. Probably, it was constructed c. 150 BC.⁵⁶

⁴⁸ Robertson 1929: 152, 153

⁴⁹ Dinsmoor 1950: 232.

⁵⁰ Fletcher 1905: 85; Dinsmoor, 1950: 232; Lawrence 1996: 154; Winter 2005: 11.

⁵¹ Jones 1991: 144.

⁵² Dinsmoor 1950: 280.

⁵³ Winter 2005: 28; Williams 1974: 405–414.

⁵⁴ Dinsmoor 1950: 280.

⁵⁵ Lawrence 1983: 160; Williams 1974: 405.

⁵⁶ See note 43 in Williams 1974: 409.

The capital of the Zeus Olbuis (Figure 10) has a set of unique interlocking central helices. The helices emerge from thickened, fluted cauliculi and coil inward facing each other. The central fleuron was replaced by "mere knob;" however, we can notice the presence of two lesser fleuron behind each of the coiling helices. The double acanthus collar covers about half (1/2) the bell. It is a rare feature that matches the Vitruvian proportion regarding the acanthus leaves.⁵⁷



Figure 10. A Corinthian capital from the Temple of Zeus Olbuis (Winter)

Therefore, it is probable that is based on Abramson's Anatolian style description, that the acanthus collar covers the lower half of the capital entirely. The curved cauliculi seem more developed than those of the *Didymaion*, but not the calyces. The stems of the corner volutes, wrapped in cauliculi, overlap the cauliculi of the central helices. Although not small as the *Didymaion*, the central helices are still small in size compared to the Mainland prototypes, as well as the calyces, compared to that of Tegea. Corner volutes have a flattened spiral surface (a Mainland feature), although the visible part of the stem is slightly curved (an Anatolian feature) – see p. 22-3.

Based on the detailed description provided by Williams, it seems that the capitals from the Temple of Zeus Olbuis were either a failed attempt⁵⁸ or a work in progress for the development of the Corinthian capital by adapting the Alexandrian style.⁵⁹ In addition to the example from Didyma, we can conclude that both examples were pre-orthodox Corinthian capitals.

Temple of Zeus Olympius, Athens

The Olympeion in Athens is one of the most important Hellenistic temples within the Hellenic domain. It is agreeable among researchers –mentioned in the list of previous studies – that it was not only the main source of influence to Roman architecture, but rather a reflection of the Ptolemaic Corinthian capitals, especially the capital from the Propylon of Ptolemy II in Samothrace – see p. 51.



Figure 11. A sketch of the Corinthian capital of the Temple of Zeus Olympius (Dinsmoor)

Although it was not the first attempt, or will it be the last, to construct the Temple of Zeus Olympius in Athena, Antiochus IV had ordered its construction by the Roman architect Cossutius⁶⁰ in 174 BC⁶¹ on the site of an older Doric temple. However, it was left unfinished, until its completion by Emperor Hadrian. In 86 BC, the Roman Tyrant Sulla marched to Athens to subdue a revolt. By observing the temple, Sulla ordered either the transformation of few capitals or one capital (Figure 11), which will be modeled, for the construction of the Temple of Jupiter Capitolinus in Rome; a theory to be later refuted and/or highly criticized in Chapter II, see p. 77-80.

⁵⁷ Lawrence 1983: 160; Winter 2005: 223; Williams 1974: 409.

⁵⁸ Lawrence 1983: 160; Dinsmoor 1950: 280.

⁵⁹ Winter 2005: 223, 324 n. 30: on the Alexandrian elements presented at the capital of the temple of Zeus Olbuis, presented by Borker. Moreover, the interlocking helices seem to be a direct Alexandrian feature. Also, this point of view supports the theory of the dominance of the Alexandrian architectural styles on other territories.

⁶⁰ Vitruvius mentions Decimus Cossutius, the Roman architect of great skill and taste, was assigned by King Antiochus IV, two hundred years after the last foundations of the Temple of Zeus Olympius were laid, to resume work, which is described as of "large dimensions, and of the Corinthian order and proportions" and "one of the rare specimens of magnificence;" see: Vitruv, *De Archit.*, Book VII, Intro., par 15, 17.

⁶¹ Vitruv, VII, *praef.* 15 and *Inscr. Att.* III, 561; Dinsmoor 1950: 280; Lawrence 1983: 159.

The design of the capital is the closest we can get to the pre-orthodox or pre-normal Corinthian capital. It is considered the first attempt that both the central helices and corner volutes emerge from the same "fluted and twisted cauliculi". The cauliculi reach the lower part of the corner volutes, appearing as a third row of leaves. The fleuron is placed over the abacus only, without any parts extending over the bell; however, its stem emerges from the central upper acanthus leaf. Therefore, it matches Vitruvian proportions of the fleuron.⁶² The acanthus collar reaches the half of the bell.

The Olympeion case is slightly different from the previously mentioned two Anatolian temples. The Olympeion is considered one of the missing links between the Architecture of the Hellenistic domain of Alexandria and that of Rome. However, to link the Olympeion and Alexandria first, this must be done in the light of the Epidauran capital and the features adapted from the Anatolian Corinthian type.

The Olympeion's capital seems like a combination of both Mainland and Anatolian styles; however still tilting the scale in favor of the Mainland style. The double acanthus collar is of an Anatolian nature, since it covers the lower half of the capital entirely. Each leaf consists of four sections, each of three teeth-like leaves. Lower and higher teeth-like leaves of adjacent leaves overlap; however they form smaller sinuses, like the Mainland type. The leaves of the lower row of the acanthus collar forms an "S" shape;⁶³ a Mainland feature. Moreover, the design of the acanthus leaves appear to be mostly Alexandrian, which will be discussed in the next section regarding Alexandria.

Fully developed cauliculi and calyces are presented – closer to the Classic Mainland type and more developed than the Hellenistic Anatolian adaptation. The helices and volutes emerge from the same cauliculi, side by side, where helices tend to reach the lower tip of the abacus, and the cauliculi tend to widen by the top; both are Anatolian features. Helices are of average size. The central helices, an element provided in most Corinthian capitals, are separated by a space, rather than being attached, as well as the stem of the fleuron. This feature is more Alexandrian, rather than Epidauran, since the Epidauran capital lacks the fleuron's stem.⁶⁴ As for the corner volutes, they have a flattened coiling surface and deeply carved, concave stems; both are Mainland features.

According to Jones, the height of capital = c. 1.90m, and the height of the bell = c. 1.60m; therefore, the height of the abacus = c. 0.30m, which is very close of being seventh (1/7) of the total height of the capital. As for the acanthus collar, since the height of leaf range = c. 0.57m, and since the presented height is 0.51m;⁶⁵ therefore, we can assume that the acanthus collar covers about two thirds (2/3) of the bell and half (1/2) of the total height of the capital. Based on previous calculations, we can deduce that the remaining third of the kalathos is dedicated to the helices, volutes and cauliculi. It is probable that on this prototype that Vitruvius had defined his proportions for the Orthodox Corinthian capital.

Seleucid Monuments and Tombs

Examples of Corinthian Capitals from Ai-Khanoum

The city of Ai-Khanoum in Afghanistan, probably the ancient city of Alexandria on the Oxus, is an ancient Hellenized city. Although the region was under Seleucid control and was established as a Hellenistic region, Greeks had reached this region prior to the conquest of Alexander. After the ruling of the Seleucid dynasty, local Greeks revolted, establishing their own kingdom, later known as the Graeco-Bactrian Kingdom in c. 250 BC. This period is mostly neglected by researchers, since art in the Graeco-Bactrian Kingdom takes a shift towards Central Asian and Indian art. Buddhism had affected the local art, even Greek rulers tended to

⁶² Lawrence 1983: 159.

⁶³ Abramson 1974: 5.

⁶⁴ Fraser 1921: 13–16.

⁶⁵ Jones 1991: 144

convert to Buddhism over time. However, Seleucid influence was clear over the architecture of Ai-Khanoum.⁶⁶ The study of the fusion of the Buddhist art along with the Seleucid art is a topic rarely discussed which deserve to be considered by future researchers.

Before discussing the following examples, one should mention that they are not the only monuments from Ai-Khanoum. There are at least three more designs of the Corinthian capital. However, they reflect the Buddhist culture. The fusion of the Central Asian, Indo-Buddhist and Hellenistic cultures require a deeper study, probably a study on its own. Therefore, I would only refer to the examples that reflect the Hellenistic design of the Hellenic domain, rather than every Corinthian capital example.

Hypostyle Hall (of a Gymnasium)

The first capital of Ai-Khanoum (Figure 12) is an example from the hypostyle hall of an unknown building – probably a gymnasium,⁶⁷ presented as a normal Corinthian capital. Since this territory was under Seleucid rule and, by that time, was still under Seleucid influence, the Anatolian type of Corinthian capital will be put into consideration. Bernard presents the proportions of the capital as: total height = 1.10m, height of kalathos = 0.92m and height of abacus = 0.14m. Therefore, this capital follows the Vitruvian ratio of 1:7, as seventh (1/7) the total height = c. 0.157m.

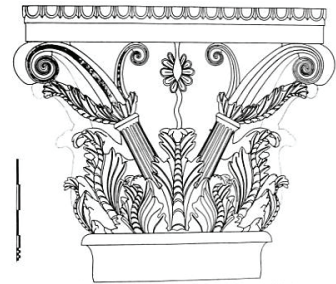

Figure 12. A sketch of the Corinthian capital from the Hypostyle Hall (Bernard and Le Berre)

The acanthus collar is presented as a double collar of overlapping acanthus leaves. The acanthus collar covers half of the kalathos. The acanthus leaves are presented in a rough S-shape with extreme bending; a Mainland feature. Each leaf is presented with a rough and thick vein. The sections of the acanthus leaves stand at triple leaflet sections with three teeth-like leaves for the upper two section and one tooth-like leaf for the lower one. It follows neither of the two types. Each leaf has seven sinuses.

Central helices and corner volutes emerge from the same calyx, wrapped with cauliculi. The stem of the volute overrides that of the helix, which is an Anatolian feature. Helices are separated with a space and the fleuron, which lies under the abacus; a Mainland feature.⁶⁸ Corner volutes have a flattened coiling surface, while their stems are divided into three sections. The middle one is carved inwards.

Propylon of Ai-Khanoum

The second capital (Figure 13) from the Propylon of Ai-Khanoum, although it seems more like a prototypical Corinthian capital, it is rather a distorted version with an exaggeration of motifs. It is also an avant-garde capital for the Late Antique models found in Alexandria.⁶⁹ The central helices and fleuron were omitted. Volutes emerge directly from the acanthus collar. The acanthus collar is not double but rather a quadruple collar. Similar capitals will adapt the same design with lesser numbers of acanthi in the Late Roman period – see Four-Leaf and V-shaped volutes capitals in Chapter III.



Figure 13. A Corinthian capital from the Propylon of Ai-Khanoum (Bernard)

The number of leaves around the kalathos 4:8:8:4. The lower row is presented by a much widened leaf that covers the face of the kalathos from one angle to the other. The third row had two leaves of each side, mounting the lower, widened

⁶⁶ Winter 2005: 230.

⁶⁷ Martinez-Sève 2014: 276.

⁶⁸ Bernard 1968: 111–151.

⁶⁹ We must consider how the trade routes established between the Roman Empire and the East played an important role in the Roman culture, especially in Egypt, since Egypt was the main port towards the East via the Red Sea.

leaf. The third row also has two leaves placed between the third row leaves and the tip of the fourth row leaf. The upper row is a single leaf of a modest sized leaf.⁷⁰

Examples of Corinthian Capitals from Asia Minor

Tomb at Belevi

The Tomb at Belevi was built by Antiochus II in c. 246 BC,⁷¹ near Smyrna. It was executed in the same style and highly influenced by the monument of Halicarnassus.⁷² It was a fusion of both the Hellenistic Doric and "Proto-Corinthian" styles. It was a close-like representation of the interior of the Temple of Athena Alea at Tegea,⁷³ see Figure 9.

Although not much was mentioned about the capital of the Tomb at Belevi, the capital (Figure 14) seems to resemble the normal type of the Corinthian capitals. The capital is circled with a double collar of acanthus leaves. The leaves are of average sides with sharp teeth-like leaves. Each leaf – based on personal observation – consists of four sections, and each section of three teeth-like leaves; thus resembling the Anatolian type.



Figure 14. A Corinthian capital from the Tomb at Belevi (Abramson)

From the acanthus collar, rises two, fully grown calyces, where the cauliculi are shown by the corners of the capitals. From the calyx, the helices and volutes rise side by side; a Mainland feature. The stems of the volutes are slightly carved inwards, while the volutes themselves coil and rise above the kalathos, forming a prominent lobe. As for the fleuron, its position is rather different from previous example. The fleuron is neither placed on the abacus nor underneath it, but rather its upper half on the lower lip of the abacus and its lower half on the exposed part at the very top of the kalathos. Its stem rises from the middle acanthus leaf of the upper row, connecting the fleuron with the acanthus collar.

Moreover, based on Jones's calculations, the height of the capital = c. 1.12m, height of kalathos = c. 0.91m, making the height of the abacus = c. 0.21m. The height of leaf range = c. 43%, making the acanthus collar covering about less than half of the kalathos, thus about almost two thirds (2/3) the capital.

The Propylon at Miletus

The Propylon of the Bouleuterion of Miletus, along with the Council House itself, was built by Antiochus IV between 175–164 BC. It was described of being with 'rich Corinthian forms.' The capitals of the Propylon were carved in the exact manner like the capital of the Temple of Zeus Olympius in Athens (Figure 11), but rather in a smaller size and a more simplified manner of details; however, the central helices and the fleuron were of a different manner.

The capital (Figure 15) is covered with a one-row collar of acanthus leaves. The acanthus collar covers half of the kalathos. Above the acanthus collar is a single acanthus leaf, from which both the corner volutes and central helices emerge.⁷⁴ However, the restoration done by Robertson shows the presence of cauliculi and developed calyces. The stems of the volutes overlap those of the helices. Central helices are minute in size. Also, the acanthus collar is a double collar of

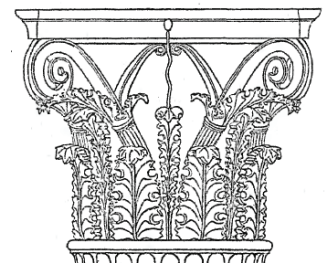

Figure 15. A sketch of a Corinthian capital from the Propylon at Miletus (Robertson)

⁷⁰ Bernard 1968: 133–137.

⁷¹ Lawrence 1983: 151.

⁷² Dinsmoor 1950: 329.

⁷³ Fyfe 1936: 53; Dinsmoor 1950: 329, 330; Fedak, 1990: 80, 81, 86.

⁷⁴ Dinsmoor 1950: 287, 296.

elongated leaves, especially the upper leaves, which stretch from the upper rim of the column towards almost half of the kalathos, and are half the width of the leaves of the first collar.⁷⁵

Moreover, proportions provided by Jones show that its height = 0.78m, height of kalathos = 0.68m, making the height of the abacus = 0.10m. Relative height of leaf range = c. 40% of the height of the kalathos, less than seventh (1/7) the Vitruvian height of the abacus.⁷⁶

Laodike Monument, Miletus

The Laodike Monument is a 'double Corinthian portico' in the city of Miletus,⁷⁷ erected in c. 259 BC.⁷⁸ Probably, the capital of the Laodike Monument was contemporary to the construction of the Bouleuterion and its Propylon – see above, p. 29-30. It was named after Laodike, wife of Antiochus III or wife of Antiochus IV, since both married from the same Pontian dynasty, ranged the date from 261–246 BC and 223–187 BC.⁷⁹

The capital of the Laodike Monument (Figure 16) has similar proportions of the capitals of the Propylon and the Tomb of Belevi. The capital is surrounded with a double collar of acanthus leaves. Each leaf is made up of four sections, and each section of three teeth-like leaves; an Anatolian feature. Emerging from the acanthus collar, strangely, seven cauliculi with calyces; a group of two adjacent cauliculi placed at each corner of the capital.

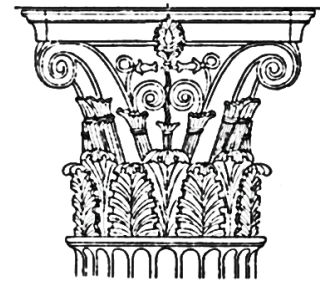

Figure 16. A sketch of a Corinthian capital from the Laodike Monument (Abramson)

In the middle of the capital are three separate cauliculi, where the central helices emerge, as well as two coiling flowers from between the helices and the volutes. The corner volutes and their stems are slightly carved inwards; however, the volutes coil in a flattened surface manner. They emerge from three cauliculi each; the two double cauliculi at the corners and the two central cauliculi along the helices and the coiling flower. Moreover, there is a central small cauliculus, where the stem of the fleuron grows towards almost the lower lip of the abacus. The fleuron lies on the entire abacus and the upper part of the kalathos.

The Zeus Olympius Capital: a Universal Seleuco-Epidauran Reflection

Before addressing Alexandria and its major role, the core of this study, it is suitable – after discussing various examples from the Hellenistic Seleucid Empire – to link all the previous examples and how they were summarized in the capital from the Temple of Zeus Olympius from Athens. Also, how the far-distanced Graeco-Bactrian Kingdom was influenced by the Seleucid culture, preserving the Hellenic culture, at least before being overtaken by the Indo-Buddhist culture.

Nevertheless, Mainland, Anatolian and what we know about the Indo-Buddhist styles will be put into comparison to identify how the Seleucid style had spread and which had the stronger impact over the Zeus Olympius capital.

It is highly probable that the capital from the hypostyle hall of Ai-Khanoum shares the acanthus collar of the temple of Tegea and the Zeus Olympius, which is the first Mainland feature. The acanthus leaves are of six sections each, divided into five teeth-like leaves; a Mainland feature. The Anatolian style calyx is presented in a fully developed manner, crowning the cauliculus. Two cauliculi emerge from the collar. The fleuron is adapted from the Epidauran capital; however, its positioning is directly and only above the abacus, like the

⁷⁵ Robertson 1929: 70.

⁷⁶ Jones 1991: 144.

⁷⁷ Dinsmoor 1950: 288.

⁷⁸ Jones 1991: 144.

⁷⁹ See Abramson, 1974: 8, note 38.

square knob from the Zeus Olbius example. The previously mentioned example places the fleuron underneath or partially above the abacus; thus an Anatolian style. The closest example that resembles a fleuron above the abacus is the Classical Monument of Lysicrates, which has a palmette instead of a fleuron. The stem of the fleuron appears to be an Anatolian feature, save for the Didymaion's capital. The volutes and helices rise side by side, not overlapping. The stems of the corner volutes are slightly carved inwards, while the volutes themselves and coiling inwards, forming a flattened surface; Anatolian and Mainland features respectively. The abacus is deeply carved inwards with prominent edges.

As a result, the general overview of the capital of the Zeus Olympius seems to look like a Mainland-influenced capital. However, the result of comparison is almost identical; in favor of the Mainland style, but highly influenced by the Anatolian one. The acanthus collar is a common feature in all capitals – save for the Ai-Khanoum hypostyle capital. The collar covers half of the kalathos. Mainland features were presented in the design of the acanthus leaves and their sections, the Epidauran fleuron, the Lysicrates positioning of the fleuron, the stem of the fleuron, volutes and helices emerging side by side, slightly carved volutes, and coiling volutes. The Anatolian style was presented through the cauliculi and calyces, though the latter was presented developed, while in many cases of the Anatolian type was presented small and undeveloped, and the flat-surfaced volutes. Cauliculi tend to widen towards the top. Therefore, the Mainland features tend to appear on elements that are worth noticing and first to be recognized, while the Anatolian features appeared on lesser details that requires a more professional view of the capital.⁸⁰

The Antiochean Question or the Origin of the Zeus Olympius Capital

It is noticeable by now that the greatest contributor to Seleucid architecture was Antiochus IV. However, the real question is that what inspired the architects of Antiochus IV in developing an Epidauran-like capital?

The acanthus collar is Epidauran, and the cauliculi and calyces were primarily introduced through the Temple of Athena Alea at Tegea. However, the Zeus Olympius capital seems to be rather more developed than just being influenced by local Mainland art, even it was partially evolved through Anatolian art. The remaining of the answer to the Antiochian question lies in the development of the Alexandrian Corinthian capitals under the Ptolemies and how it affected Samothrace – see p. 51-52, the Levant region and the Nabataean Kingdom, since all four existed since the 3rd century BC. Moreover, the real designer of the temple was Cossutius, who was of Roman origins. Therefore, another question is raised about the inspiration that influenced Cossutius to construct the Temple of Zeus Olympius in such manner – a topic which will be traced in Chapter II.⁸¹

The Alexandrian Corinthian Capital: Typology and Analysis

During the same time, when the Seleucid Empire and especially in the reign of Antiochus IV were concerned with grandiose constructions, the Ptolemies in Egypt were not idle. They were rather more active and more productive regarding architectural evolution. The city of Alexandria was the seat of their power, establishing it as a hub for both commerce and education.

Under the Ptolemies, Alexandrian architecture was divided into two architectural styles, which I shall be naming them the Standard/Classical Alexandrian Architecture and the Baroque Architecture periods. The latter did not replace the prior, but rather co-existed alongside; however, Baroque Architecture appeared in a later period.⁸² The Baroque architecture was more concerned with pediments and modillions, thus preserving the Alexandrian Hellenistic capital designs.

⁸⁰ Bernard 1968: 119–125.

⁸¹ See p. 110, Figure 216.

⁸² McKenzie 2007: 83.

The Alexandrian Hellenistic Corinthian capitals were divided into four types. The first three types were based on the Epidauran capital,⁸³ while the fourth type was based on the classical ‘Double-Volute’ capital from Olympia.⁸⁴ The distinguishing element among the first three examples is the central helices; their orientation and direction. However, the fourth is easily recognizable, where central helices are omitted.

According to McKenzie, the design of the Alexandrian Corinthian capital does not present the cauliculi and calyces, where the volutes and helices emerge directly from the collar – save for the Type IV. Her perspective is almost accurate; however, by observing the central helices, it appears that the cauliculi emerge along the helices towards the top of the kalathos, before it coils. Sometimes it appears fluted, while others are not. As for the calyx, it is very small and undeveloped. Both cauliculi and calyx are part of the stem of the stems of the central helices, making them almost unnoticeable. However, not all cases were presented with a wrapping cauliculus.

Unlike the Hellenic Realm, Alexandria does not fall under the category of being a common excavation site. Examples of capitals discovered within Alexandria somehow differ from the rest of Egypt or any other region that was under Ptolemaic rule. Examples from other territories that are similar to Alexandria came to happen after the development of the Alexandrian style. However, the Ptolemaic domain is divided into three sections: Alexandria, Ptolemaic Egyptian, and other territories under Ptolemaic influence or came into contact with the Ptolemies. The latter is divided into two sub-categories, which I shall discuss later in this chapter.

In order to submit the Alexandrian Corinthian capitals to both mathematical and artistic categories, to reveal their characteristics, each discovered piece will be submitted to an analytical study. Almost each capital and each element presented will be analyzed separately, then in relation to the entire capital, then the capital to other capitals. However, not every fragment discovered was a complete capital. Half capitals and fragments of capitals were discovered. Based on the data provided by Both Patrizio Pensabene and Barbara Tkaczow, the examples at hand will be linked to the standards of the Alexandrian Corinthian capital provided by Both McKenzie and Ronczewski. Graeco-Roman Museum Annuals by Adriani, Botti and Breccia will shed light over early discoveries regarding the Corinthian capitals. I shall be dividing the fragments closely according to the division provided by Tkaczow in her two books regarding the topography of Alexandria and the Polish excavations held in Kom El-Dekka, and the detailed subcategorizing according to Pensabene.⁸⁵

The Four Types of the Alexandrian Corinthian Capitals in Regards of Anatomy, Designs and Proportions

Type I Alexandrian Corinthian Capital

Type I of the Alexandrian Corinthian capitals (Figure 17) is very likely based on the Epidauran type (Figure 7). The double central Helices emerge directly from the acanthus collar without the presence of a cauliculus or a calyx, according to some researchers. However, very thin and small cauliculi and undeveloped calyces wrap around the stems of the helices as parts of them, difficult to identify. Each helix springs from one acanthus leaf. The two central volutes coil inwards in face of each other.⁸⁶ The fleuron is placed directly on the abacus, where its stem emerges from a central, upper leaf placed behind the central acanthus leaf of the upper row of the collar.

Type I Alexandrian Corinthian is the first, oldest, most-used design in Ptolemaic Alexandria, with ties until the 6th century AD – see Chapters II and



Figure 17. A sketch of the Type I Alexandrian Corinthian capital (McKenzie)

⁸³ Ronczewski 1927: 4; Ronczewski discussed that even capitals adapted from the Epidauran design were treated in an original, creative and local way of design.

⁸⁴ McKenzie 2007: 86.

⁸⁵ Pensabene 1993: 114, 115.

⁸⁶ McKenzie 2007: 86.

III for adaptations. Based on the previously mentioned prototypical design of the Type I capital, we can recognize through analyzing unearthed capitals, that Type I capitals were not all presented in the same manner. Type I capitals can be subdivided based on the design of corner volutes and the cauliculi of the corner volutes and central helices; Free and Normal capitals. Moreover, Free (non-canonized) Type I capitals were the most used type in Ptolemaic Alexandria; starting from the 3rd century BC, while the Normal capitals came to exist by the Roman period.

Free Type I capitals are recognized based on the style of volutes and helices, mainly, as well as other proportions. Free capitals have their helices away or slightly close to the abacus, but never touching or intersecting with its base. The volutes, with or without cauliculi, emerge directly and independently from the acanthus collar, without any form of support.⁸⁷

Free Type I capitals are subdivided into two subcategories, mainly distinguished via the corner volutes designs as follows (see cat. no. 1-32):

The first subcategory (Figures 18–34) has water plants for volutes. The subcategory itself is divided into three sectors, based on the design of the helix; they are divided into groups with: grooved helices wrapped with cauliculi, convex helices wrapped with cauliculi, and grooved helices without cauliculi. This subcategory resembles mostly the Epidauran type.

Regarding the upper section of the capital, both helices are separated from the abacus with an exposed space of the kalathos. However, this type differs from the Epidauran type by hosting the coiled stem of the fleuron's calyx on the top of the kalathos, rather than the fleuron itself – unlike the Epidauran type – in which the fleuron lies on the abacus. Although this type resembles the Epidauran type, the grooved, *non-cauliculated* examples are the most close to the Epidauran type, mostly noted on the capital from Khartoum Square (Figure 22).

Regarding the lower part of the acanthus collar, the Alexandrian type had adapted both the Mainland and the Anatolian designs of the acanthus leaf. On the one hand, the capitals with concave helices had adapted the Mainland design of three sets of leaflets with five teeth-like endings. On the other hand, capitals with convex helices had adapted the Anatolian type of acanthus leaves with two sets of leaflets and three teeth-like endings.

Based on the categorization presented by Pensabene, we can divide the first subdivision of the Free Type I capitals into three sectors as follows:

Concave central helices with cauliculi

This design of capitals has concave central helices wrapped with cauliculi (Figures 18–21). Figure 18 is considered the clearest example of this group. By analyzing examples at hand we can conclude that the following:

- Helices are always presented away from lower lip of the abacus (Figure. 19); however, there is an exception where the helices are slightly close to the abacus (Figure 18).
- The helices emerge from the calyces mounting the fluted cauliculi (Figure 18).
- The fleuron is placed directly on the abacus or mostly on the abacus with its lower calyx or supporting leaves on the highest point of the abacus (Figures 18-20).
- The stem of the fleuron is either presented emerging from the acanthus collar and twisted by the lower lip of the abacus (Figure 18) or presented hidden behind a straight acanthus leaf (Figure 19).
- Corner volutes are presented as water leaves with medium-sized coils (Figure 18) or slightly enlarged coils (Figure 21)

⁸⁷ Pensabene 1993: 112, 113, 115.

- The acanthus collar leaves are presented in sets of three leaflets with open, almond-shaped sinuses (Figures 18).

Figure 18: A Type I Corinthian capital. The left volute, right most corner of the abacus and acanthus leaves' tips are broken. The capital consists of a double acanthus collar; six leaves for the lower row while seven at the upper row. Acanthus leaves form concave, with open sinuses. Lower row leaves are divided into seven sectors, while the upper are five. Central helices are wrapped with thin, fluted cauliculi and semi-developed calyces. Two lesser fleuron emerge with thin stems from behind the central volutes and from the same calyx. Corner volutes emerge from the corner leaves; however, the leaves are not acanthus, but rather water plant leaves. The central fleuron is placed within the height of the abacus. Its stem coils around itself and emerges from the central upper acanthus leaf.⁸⁸



Figure 18. A Type I Alexandrian Corinthian capital from the Graeco-Roman Museum, Alexandria (Pensabene)



Figures 19-21. Type I Alexandrian Corinthian capitals from the Graeco-Roman Museum, Alexandria (Pensabene)

Concave central helices without cauliculi

This design of capitals (Figures 22–25) appears to be like the previous one, only noticeable that the helices are deprived of the cauliculi and calyces. The two clearest examples are the capital of Khartoum Square (Figure 22) and a pilaster from Mostafa Kamel Tombs (Figure 23).

⁸⁸ For more, see Pensabene 1993: 352, cat. no. 180.

- Central helices are presented away from abacus (Figures 22, 24), with exception of being slightly close to the abacus (Figure 23) or very close (Figure 25)
- The helices emerge directly from the acanthus collar (Figures 22, 23, 25), where Figure 24 has reduced helices.
- The fleuron is placed directly on the abacus or mostly on the abacus with its lower calyx or supporting leaves on the highest point of the abacus (Figures 22, 23, 25).
- The stem of the fleuron is always visible, presented as a straight line (Figures 22, 23), except for Figure 25, which is partly visible, with a semi cruciform-like leaves.
- Corner volutes are of water plants. All ending coils from Alexandria are broken (Figures 22–25). Other similar examples with presented endings are found in Upper Egypt – see below, p. 47–9.
- The acanthus collar leaves are presented in both sets of doubles (Figure 22) and triples (Figures 23–25), with opened sinuses (Figures 22–25).

Figure 22: The Capital from the Khartoum square is worth noting and requires an analysis of its own. Although it follows the same standards of the subcategory mentioned above, it is one of the oldest capitals, dating to the 3rd century BC or even the 4th century.⁸⁹ It is also carved out of basalt; one of the strongest materials used to sculpt a capital, of which a very few and handful number of basalt capitals are found. Features of the capital are not presented at great depth, but rather on a shallow level; probably due to the hardness of basalt. Moreover, it was perfectly carved in the Epidauran manner, unlike other examples of exaggerated ratios. The acanthus leaves of this capital falls to less than the height of the kalathos, unlike the Epidauran one. It covers two fifth (2/5) the kalathos, rather than half. This capital is ‘much slender and the volutes rise much higher above the acanthus crown;’ a reflection of Alexandrian craftsmanship. Therefore, the Khartoum capital is rather more of a modified model of the Epidauran one.⁹⁰

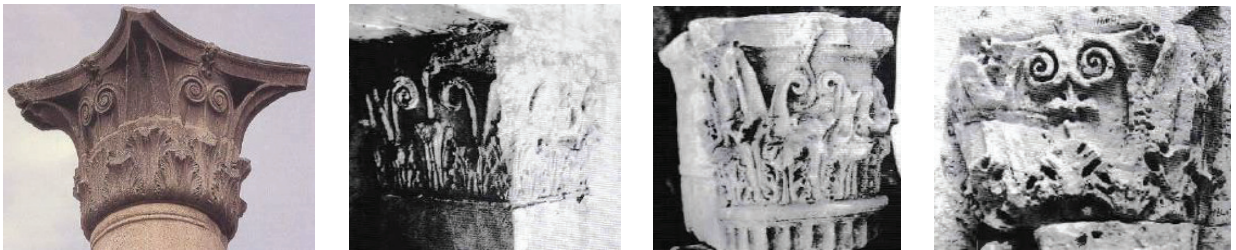

Figure 22. (left) A Type I Alexandrian Corinthian capital from El-Khartoum Square, Alexandria (McKenzie)

Figure 23. (middle left) A Type I Alexandrian Corinthian pilaster from Mostafa Pasha Necropolis, Alexandria (Pensabene)

Figures 24-25. (Middle right & right) Type I Alexandrian Corinthian capitals from the Graeco-Roman Museum, Alexandria (Pensabene)

Convex central helices with cauliculi

This type of capitals (Figures 26–28) matches the first one, only the design of helices changes from being concave into convex. By considering Figure 26 as a prototypical example for this group, and also by analyzing other capitals and fragments of the same type, we conclude:

- Central helices are presented in closer to the abacus than the previous types (Figures 26–28).
- The helices are presented in convex motif, wrapped with fluted cauliculi and emerge small calyces mounting the cauliculi (Figures 26–27), except for Figure 28, where the cauliculi and calyces are replaced with *acanthized* or palm-tree motif cauliculi.

⁸⁹ Ronczewski 1927: 6; Ronczewski sites Diebruck regarding the dating of the capital.

⁹⁰ For more, see Ronczewski 1927: 6, 8; Pensabene 1993: 357, 358, cat. no. 203.

- The fleuron is placed directly on the abacus in few cases or mostly on the abacus with its lower calyx or supporting leaves on the highest point of the abacus (Figures 26, 28).
- The stem of the fleuron is partly visible between the coils of the helices and its lower part is covered with a straight acanthus leaf emerging from the acanthus collar over the central leaf (Figures 26-27), except for Figure 28, where the stem emerges directly from the collar without the presence of the straight acanthus leaf.
- Corner volutes are of water plants (Figures 26, 28).
- The acanthus collar leaves are presented in triple sets of leaflets (Figures 26, 28).

Figure 26: Type I Corinthian capital. Central helices and corner volutes emerge from the same leaf. Helices are wrapped with very thin fluted cauliculi, which is difficult to notice. The coiling ends of the helices have wrapping calyces. The volutes are of water plants. The capital has a double acanthus collar. The lower row has three sets for leaves, and forms widely-opened sinuses. Central fleuron rests on the abacus and upper part of the bell. Two lesser fleuron rests between the angles formed of the volutes with the lower lip of the abacus. The central fleuron's stem is covered behind the straight acanthus leaf emerging from behind the upper central leaf of the collar.⁹¹



Figures 26-28. Type I Alexandrian Corinthian capitals from the Graeco-Roman Museum, Alexandria (Pensabene)

The second subcategory of the Type I capitals also falls under the 'Free' type of capitals. This subdivision is mainly marked with the cauliculi wrapping around the corner volutes, different from the ones of the central helices. Helices are also wrapped with cauliculi. This design was adapted from the Laodike of Miletus and the Philippeion capitals, regarding the volutes – see above. This design was later adapted on the Italo-Corinthian capitals,⁹² forming a bridge between the early Roman designs and the Alexandrian one – see below Italo-Hellenistic Corinthian capitals in Chapter II, p. 63-7.

Unlike these examples, which have fully developed calyces, the Alexandrian adaptation of the side cauliculi has copied the small-leafed calyces of the central helices for the volutes. The central area between the helices and the acanthus collar is covered with a flattened, straight acanthus leaf, as well as other identical leaves covering the corner areas between the corner volutes; also a latterly-adapted Sicilian feature. The design of the acanthus collar had varied; however, it seems that this design did stick to the three endings of the leaflets rather than the five ones.

By observing examples at hand, we can deduce that this subcategory (Figures 29–32) has a variety and a wide range of changing of motifs, excluding the convex helices and their fluted cauliculi:

- Central helices are presented very close to the abacus (Figures 29–32).

⁹¹ For more, see Pensabene 1993: 355, cat. no. 190.

⁹² Pensabene 1993: 119.

- The helices are presented in convex motif, wrapped with fluted cauliculi and emerge small calyces mounting the cauliculi (Figures 29–31).
- The fleuron is placed partly on the abacus and partly on the kalathos (Figures 29–31).
- The stem of the fleuron is either presented emerging from the acanthus collar directly (Figures 29–30) or partly appearing between the coiling helices and the rest of it is hidden behind the straight acanthus leaf (Figure 31).
- Corner volutes are wrapped with fluted cauliculi. They are presented as either attached to the helices' cauliculi (Figures 29, 31) or slightly diverging from it (Figure 30).
- Corner volutes of each side pair at a certain area on the corners of the capital. The cauliculi pairs at these corners are either presented close with a wide acanthus leaf appearing behind the pair (Figure 32) or presented afar from each other, with a straight acanthus leaf appearing between them (Figure 29).
- Acanthus leaves of this type are presented in triple sets with open sinuses (Figures 29–32).

Figure 29: Type I Alexandrian Corinthian capital. A double acanthus collar of eight flat leaves. Sinuses are formed in a triangular shape. Leaves of the upper row are folded. Both volutes and helices are wrapped with fluted cauliculi, each, and wrapping calyces. Corner volutes are separated with a flattened acanthus leaf emerging from the collar towards right below the abacus.⁹³



Figures 29-31. Type I Alexandrian Corinthian capitals from the Graeco-Roman Museum, Alexandria (Pensabene)



Figures 32-33. Type I Alexandrian Corinthian capital and a fragment from the Graeco-Roman Museum, Alexandria (Pensabene)

Another type for the Type I capitals is the ‘Normal’ Corinthian capitals. Although not much examples were found regarding the Normal Type I capitals, they are dated to the Roman period – see Chapter II, p. 97-9.

Moreover, there is a unique example for Type I capitals with its central helices interlocked (Figure 33). This capital could be categorized under the ‘Free’ capitals with water plant volutes. However, Pensabene had distinguished it as a Corinthianized capital rather than being originally Corinthian. I would differ, since the capital matches the standard designs of the Corinthian capital, except for the interlocking helices, which is a free style of sculpting regarding ‘Free’ capitals. Within Type I Alexandrian capitals is a unique and rare example of an Egyptianized Corinthian capital:

⁹³ For more, see Pensabene 1993: 366, 367, cat. no. 241.

Figure 34: An Egyptianized Type I Corinthian capital. The lower part consists of a collar of papyri bundle. Above the bundle is a double collar; the lower row is papyri and the upper is acanthus. Two smaller leaves emerge from the middle acanthus leaf and form sinuses. The volutes are water plants. Central helices are wrapped with lotus-shaped cauliculi. Beneath the helices is another papyrus leaf growing from the upper acanthus leaf, and in front of it is the stem of the fleuron. Above the abacus are traces of the Egyptian winged sun-disk. Two lesser fleuron are placed at the corner between the lower lip of the abacus and the volute.



Figures 34. Egyptianized Type I Corinthian capitals from the Graeco-Roman Museum, Alexandria (Pensabene)

Type II Alexandrian Corinthian Capital

Type II (Figure 35) is opposite to Type I in regards of the helices. Although the helices also spring directly from the acanthus collar, they spring outwards, opposite to each other and they are back to back.⁹⁴ Their backs are attached to each other. Unlike Type I, both helices spring from the same central leaf of each side. Moreover, there is no upper central acanthus leaf. The fleuron is placed directly on the abacus, while its stem emerges from between the backs of the helices.



Figure 35. A sketch of the Type II Alexandrian Corinthian capital (McKenzie)

Type II capitals (Figures 36–40) are easier to distinguish from Type I, since they have a standard design of the central helices growing from the same leaf, with back-to-back stems. However easier to identify, they are much fewer in number. The sectors of this type vary, but each section includes a handful of examples (also see cat. no. 33-43, 45).

Regarding the upper section of the capital, all helices have the same design. However, helices might grow directly from the acanthus collar or both helices wrapped with a single cauliculus and emerging from the same calyx. The calyx is always small in size and not fully developed. The volutes differ in their type as designs. They are either presented as wrapped in fluted cauliculi or floral cauliculi or water plant volutes, or supported with flattened, straight acanthus leaf at each corner.⁹⁵

Although all presented Type II capitals are corroded, we can identify the number of leaflets based on the number of sinuses. This type has adapted the Mainland design of the acanthus leaf. Each leaf has three sets of leaflets. Each leaflet consists of five teeth-like endings. Fleuron seem to be placed fully on the abacus, with its stem hidden behind and growing from between the two helix stems.

By observing examples at hand, we can deduce the following as the various motifs presented on Type II capitals in Alexandria:

- Central helices are presented very close to the abacus (Figures 36, 37, 39).
- The helices are presented with their stems back to back. The helices are either presented emerging directly from the acanthus collar (Figure 36) or growing from one cauliculus mounted with one calyx (Figure 37), or emerging from two independent cauliculi (Figure 39).
- The fleuron is placed directly on the abacus (Figures 36, 37, 39).
- The stem of the fleuron is hidden between the backs of the cauliculi and appears by the top of the kalathos with the calyx of the fleuron right under the lower lip of the abacus (Figures 36, 37, 39).

⁹⁴ McKenzie 2007: 86.

⁹⁵ Pensabene 1993: 119.

- Corner volutes are wrapped with cauliculi. However, the cauliculi are either presented as water plant (Figure 36) or *acanthized* (Figure 37) or fluted (Figure 38).
- Corner volutes are either shown as pairs (Figures 39) or separated with a straight acanthus leaf at the corners of the capital (Figure 37).
- Acanthus leaves are presented with double sets of leaflets and opened sinuses (Figures 36–40).

Figure 36: A double Type II Alexandrian Corinthian capital. Abacus is damaged and corner volute endings are broken. Double acanthus collars wrap both capitals. Sinuses are almond-shaped and opened. Central helices are wrapped with cauliculi and calyces. Central fleuron is placed between the abacus and helices on the kalathos. The stem of the central fleuron emerges from between the helices. The capital matches Figures 23, 24 and 28 regarding the style (except for the helices) and Figures 38 and 39 in regards of the acanthus design.⁹⁶

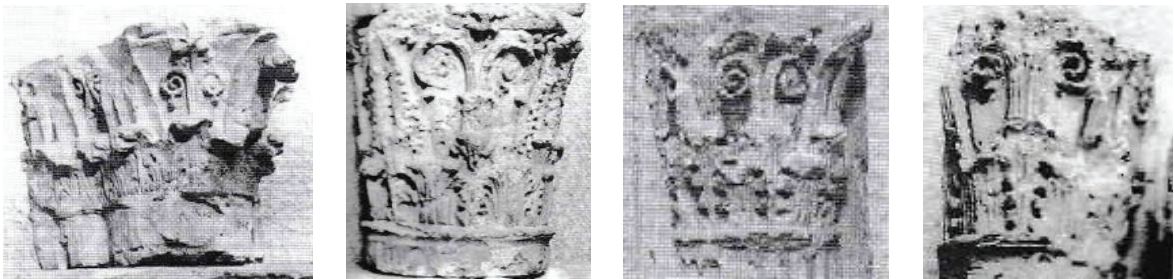

Figures 36-39. Type II Alexandrian Corinthian capitals from the Graeco-Roman Museum, Alexandria (Pensabene)

Like Type I, there is another unique and rare Egyptianized version of the Type II Corinthian capital:

Figure 40: A Type II Egyptianized Corinthian capital. Around the capital is a double collar of papyri leaves for the lower row and acanthus for the upper row, with open sinuses. Above the central acanthus leaf is three-leaf palmette-shaped calyx of which the cauliculi rise. The central leaf of the palmette forms the stem of the fleuron; the latter is placed on the abacus. Another papyrus is placed between the helices. The helices are concaved and separated by a large papyri leaf extending from the palmette leaf placed on the upper collar towards the abacus. Corner volutes are wrapped with cauliculi and appear as pairs by the corners.



Figures 40. Egyptianized Type II Corinthian capital from the Graeco-Roman Museum, Alexandria (Pensabene)

Type III Alexandrian Corinthian Capital

Type III Alexandrian Corinthian (Figure 41) is considered, according to some scholars, as a derivation of Type II. Both Helices are presented springing from the acanthus leaves collar, back to back and the helices spin outwards.⁹⁷ However, the back-to-back helices emerge from two different acanthus leaves on the sides of the central leaf, leaving a gap at the lower sides of the stems. The use of the side helices are that of Type I. The fleuron is placed on the abacus, while its stem emerges from a central upper acanthus leaf emerging from behind the central leaf of the upper row of the acanthus collar. Thus, I would prefer to refer to it as a mix of both Types I and II.

This type was widely used that it came second to Type I. I shall be discussing only one example, since one design had appeared in Alexandria. Other variations from Upper Egypt will be discussed later. This type had mainly started to appear from



Figure 41. A sketch of the Type III Alexandrian Corinthian capital (McKenzie)

⁹⁶ For more, see Pensabene 1993: 373, cat. no. 270.

⁹⁷ McKenzie 2007: 86.

the middle of, or preferably, by the end of the 2nd century BC, with the same design extending throughout the 1st century AD.⁹⁸ It was widely used in Upper Egypt rather than Alexandria. However, it was still used in Alexandria nonetheless. This type is identified by the two designs of its helices. In both designs, the central helices are presented in the direction of Type II but with the lower parts of the stems apart from each other and each stem emerging from a different leaf, like Type I. In other words, they can be identified as 'lyre-form' in design (also see cat. no. 46-50).

There are two categories regarding each of the main three distinguishing elements of the capital. Corner volutes are wrapped with fluted cauliculi in both cases. One case has a flattened, straight acanthus leaf supporting the corners and the other one is without, but rather a double cauliculi for the volutes. Also, the first category has its helices back-to-back, with a space left between their stems.

Leaves of the acanthus collar are presented in both round and triangular ending forms. Both the round edged and the triangular edged had adapted the Anatolian pairing of two pairs of leaflets per leaf, as well as the triple leaf endings from the same Anatolian design. Central helices are always wrapped with cauliculi and emerging from small calyces coiling around the helices. The helices are always presented in a convex design, unlike Type I which had both the concave and convex design.⁹⁹

The other form has the backs of the two central helices interlocked. They match the previous form regarding the acanthus collar and the division of lobes and the form of leaflets. All capitals of this form have double cauliculi for the corner volutes.

Although most of this design is found in Upper Egypt, there are few examples unearthed in Alexandria. These examples will show how this lyre-form capital came to exist and how it will be adapted or differ from those found in Upper Egypt and later in the Roman period (detailed analysis of the capitals are applicable to all examples, without need of mentioning each capital along with every point:

- Central helices are presented slightly close to the abacus.
- Central helices are presented in a lyre-form. There are other examples with debatable dates ranging between the Late Ptolemaic period and the early Roman decades from the 1st century AD. I shall present them in Chapter II along the rest of the Roman examples of how they formed a transactional bridge between the two eras – see p. 101.
- Fleuron is presented directly on the abacus.
- The stem of the fleuron emerges directly from the acanthus collar, passing through the coiling helix backs and up towards the fleuron.
- Corner volutes are presented as double pairs at the corners, wrapped in fluted cauliculi.
- Leaves of the acanthus collar vary between double sets of triplets.

Figure 42: A double Type III Alexandrian Corinthian capital, referred to as lyre-motif. Abacus is damaged. Spiral endings of volutes are broken. Both capitals are surrounded with a double acanthus collar, with sets of fours for the lower row leaves and sets of threes for the upper row. Volutes and helices emerge separately. Corner volutes are wrapped with thick, fluted cauliculi, while the central helices are wrapped with thin cauliculi and small calyces. The corners of the capitals are covered with straight acanthus leaves, one for each corner. All sinuses of the acanthus leaves are opened and almond-shaped. The stem of the abacus' flower rises from between the helices.¹⁰⁰



Figure 42. A double Type III Alexandrian Corinthian capital, Graeco-Roman Museum, Alexandria (Pensabene)

⁹⁸ Date is based on the dating of capitals and fragments presented by Pensabene.

⁹⁹ Pensabene 1993: 113.

¹⁰⁰ For more, see Pensabene 1993: 370 & 371, cat. no. 256.

Figure 43: A mixed capital with motifs, which combines Type I, Type II and Type III of the Alexandrian Corinthian capital. The double leaf collar consists of two vine leaves per side for the lower row and acanthus leaves for the upper and the remaining of the lower row. Sinuses are almond-shaped and opened. The corners are covered with spear-head like leaves. The lower part of the helices stem emerge from the same leaf, resembling Type II capital, while the rest of the helices are curved or 'lyre-shaped' resembling Type III.¹⁰¹



Figure 43. A mixed Alexandrian Corinthian capital, Graeco-Roman Museum, Alexandria (Pensabene)

Type IV Alexandrian Corinthian Capital

Type IV Alexandrian Corinthian capital (Figure 44) is unique and different from the previous three ones. It is not related to the Epidauran capital, but rather to the Double Volute capital from Greece – i.e. the capital from Olympia and, sometimes to, the capital from the Tholos of Delphi. The capital of such type consists only of the two external volutes, which continue to spring inwards, replacing the helices and cauliculi from the previous types. Unlike the first three types, about the doubtfulness of the cauliculi and calyces, we are certain about their omission and replacement. The double acanthus leaves collar is also removed; however, it is sometimes either replaced by a 'necking band' of rosettes, or totally omitted or left blank.¹⁰²



Figure 44. A sketch of the Type IV Alexandrian Corinthian capital (McKenzie)

This type (Figures 45-48) might be the most unique but the least lucky of all the four types. It started to develop by the late 2nd century BC, although the conception of the double S-shaped volutes had existed in Greece long before – Double Volute and Delphi capitals – see p. 19, and cat. no. 51-59.

In absence of the helices, cauliculi, calyces and the acanthus collars, the main of the capital of this type becomes the volutes and the fleuron. The simplest recognizable motif is the band surrounding the capital, which replaces the acanthus collar. The examples at hand show that it was either left empty, replaced with a band of rosettes of fives and fours, or carved with a meander motif, regarding one example. There are two examples where the fleuron is replaced with a flying gorgon face. There is always one acanthus leaf at each corner to support the volutes. These acanthus leaves share both the elongated, opened sinuses and the enclosed, round sinuses. Here, the adaptation of Mainland or Anatolian acanthus design is not related to the number of leaflets.¹⁰³

Regarding the double S-shaped volutes, they are presented either in a whirl-like motif, or a semi-finished/incomplete design, wrapped with cauliculi and emerging from semi-developed calyces, or with a spear-tip-like coiling motif, which is sometimes presenting the two volutes interlocked.¹⁰⁴

Although Type IV capitals are presented with fewer motifs than the previous three types, each capital could be unique in its design. The following analyzing of the capitals reflects their motifs:

- In absence of helices, the inward coiling volute is presented far from the abacus (Figures 45–47).
- Inner volutes are presented in a convex manner. They are either wrapped with cauliculi (Figures 45, 47) or designed like spears' tips (Figure 46).
- The fleuron is presented as a cruciform fleuron between the inner volutes and lower lip of the abacus (Figure 45) or replaced with a gorgon face motif (Figure 46).
- One acanthus leaf is presented at each corner to support the extending corner volute (Figures 46, 47).

¹⁰¹ For more, see Pensabene 1993: 377; cat no. 294.

¹⁰² McKenzie 2007: 86.

¹⁰³ Pensabene 1993: 120.

¹⁰⁴ Pensabene 1993: 114.

- The bottom of the capital is either wrapped with a meander motif (Figure 48), or a band of rosettes (Figure 46), or left blank (Figure 45), or dental-like motif (Figure 48).

Figure 45: A Type IV Corinthian capital. Abacus, left side volute and the part of the fleuron are missing. Two acanthus leaves are placed at the corners each, mounted by the fluted cauliculi of the volutes. The volutes emerge from calyces. There are traces of lesser fleuron rising from behind the coiling volutes. The central fleuron is cruciform-like. Its stem rises from between the double S-shaped volutes.¹⁰⁵



Figure 45. A Type IV Alexandrian Corinthian capital, Graeco-Roman Museum, Alexandria (Pensabene)

Figures 46A-B: A Type IV Corinthian capital. Most of the abacus, half of the right side and the upper left side are broken. Two acanthus leaves are placed at the corners each. The acanthus leaves are divided into four sets of leaflets each. The sinuses presented are wide, round, deep and enclosed. Above the acanthus leaves are the thin stems carrying fluted cauliculi; the latter are thin by the edges of the capital and gets wider by the center. Two grown calyces emerge from the cauliculi, and from them grow another cauliculi with other calyces, but smaller in size. From the second, smaller calyces emerge two stems with two leaves of a flower placed at the corners between the non-fluted stem and the lower lip of the abacus. In the middle between the center volutes is a winged figurine of the gorgon, prominent with deep details. The other side of the capital is the same, save for the gorgon's face. The center volutes are interlocked like some examples of the Type III capitals. The volutes of the side are of the same surface, without fluted cauliculi or calyces. The emerging fleuron are replaced with thin coiling stems. There is a band of rosettes surrounding the capital, replacing the acanthus collar. The frontal side has five rosettes, while the sides have four rosettes.¹⁰⁶

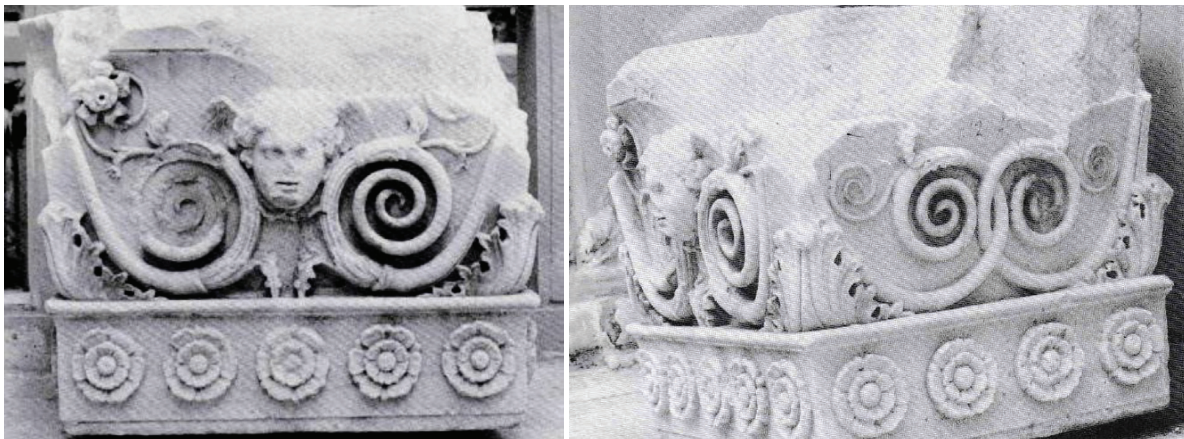

Figure 46A-B. A Type IV Alexandrian Corinthian capital, Graeco-Roman Museum, Alexandria (Pensabene)

Figure 49: It is a Type IV reduced capital. The capital is very simplified, with reduced motifs. The inner volutes are presented as bulk, with shallow fluted cauliculi. The abacus and lower part are totally blank. There are slight traces of a fleuron. The supporting leaves by the corner are very blunt and sharply curved. There are no traces to identify the type of the leaf. There is a small square in between the inner volutes; probably to represent the stem of the fleuron or another anonymous motif.¹⁰⁷

¹⁰⁵ For more, see Pensabene 1993: 380 & 381, cat. no. 305.

¹⁰⁶ For more, see Pensabene 1993: 382 & 383, cat. no. 316.

¹⁰⁷ For more, see Pensabene 1993: 383, cat. no. 319.



Figure 47-49. Type IV Alexandrian Corinthian capitals, Graeco-Roman Museum, Alexandria (Pensabene)

Buildings Decorated with Corinthian Capitals in Alexandria

In this section, I shall be discussing capitals attributed and accredited to temples and monuments erected by Ptolemaic kings. These buildings had few capitals unearthed in-situ by archaeologists, or mentioned via historians through their sources, who witnessed them firsthand.

The Sarapeion

The Sarapeion was built by Ptolemy III Euergetes I, according to the temple's foundation plaques. It was the most important sanctuary in Alexandria, dedicated to the Graeco-Egyptian god Sarapis. The temple had witnessed various stages of development throughout both the Ptolemaic and Roman periods, especially the latter.¹⁰⁸

Although the function of the temple does not concern us, it was essential to mention the sanctuary itself, since it was held by Corinthian columns from the 3rd century BC.¹⁰⁹ The presented capital from the Ptolemaic period is of the Type I Alexandrian Corinthian capitals.



Figure 50. A Type I Alexandrian Corinthian capital, Sarapeion, Alexandria (McKenzie)

Figure 50: It is an upper part of a Type I capital with overly-large helices. The helices are concave and wrapped with an *acanthized* calyx. The remaining part of the right volute appears to be a water-plant-like. The central helices have a straight acanthus leaf underneath them with curved leaflets. The lower drum of the same capital shows the double acanthus collar and the fluted cauliculus of the right helix. The leaves of the acanthus are of triple sets of leaflets. The leaflets form almond-like enclosed sinuses.

The Temple of Sarapis, Isis, Ptolemy IV Philopater & Arsinoe III

Although the available evidences about this temple are uncertain, only foundation plaques and probably a couple of capitals refer to the temple.¹¹⁰ It was built by Ptolemy IV and Arsinoe III in the second half of the 3rd century BC. Its location was on the main East-West Street.¹¹¹

Figures 51-52: Two Corinthian capitals attributed to this temple. They belong to the free, convex helices category of the Type I Alexandrian capitals with convex helices – see p. 36-7 – since they were unearthed during the foundation of Club Mohamed Ali, Currently El-Horeya Cultural Center, the same or a very nearby location where the temple once stood. Such early dating for the temple reflects the variety of motifs

¹⁰⁸ McKenzie 2007: 53 – 55.

¹⁰⁹ McKenzie & Gibson 2004, p. 86; Tkaczow, Barbara 2008: 41.

¹¹⁰ McKenzie 2007: 64.

¹¹¹ Adriani 1966: 253.

presented on Corinthian capitals from the early years of Alexandria for using convex helices rather than the Epidauran concaved helices.¹¹²



Figures 51-52. Type I Alexandrian Corinthian capital, Graeco-Roman Museum, Alexandria (McKenzie)

The Thalamegos of Ptolemy IV Philopator

The Thalamegos or the Floating Palace of Ptolemy IV was one of the grandest boats to roam the waters in Antiquity. It was a two-storey palace with a banquet hall and many bedrooms.¹¹³ The ship was originally designed for sailing inland waters. It consisted of a double bow and twin stern. It also reflects the closest image we can get for a Ptolemaic palace.¹¹⁴ What matters to us is the dining room and the temple or shrine dedicated to the Greek goddess Aphrodite, since both were decorated with Corinthian capitals.

The dining room (Figure 53) was surrounded with a row of Corinthian columns, on three sides of the room. These capitals were covered in gold and ivory. Such capitals match the design of Figure 13 from the Type I Alexandrian Corinthian.¹¹⁵ On the second floor was the 'rotunda-shaped,' temple-like 'shrine of Aphrodite' (Figure 54), decorated also with Corinthian columns.¹¹⁶ It is the earliest recorded temple to be executed in the manner of a tholos.¹¹⁷ The latter is reflected in both the architecture of Petra and the Second-Style Wall Paintings of Pompeii – see Petra in p. 52-5 and Pompeii in p. 68-72.

¹¹² Pensabene 1993: 355, 356. Capitals from the Temple of Sarapis and Isis is identical to Figure 26.

¹¹³ McKenzie 2007: 62.

¹¹⁴ Pfrommer 1999: 93, 94.

¹¹⁵ Pfrommer 1999: 103; Athenaeus, *Deipnosophistae* V.III, 429.

¹¹⁶ Athenaeus, *Deipnosophistae* V.III, 430; McKenzie 2007: 62.

¹¹⁷ Pfrommer 1999: 110.

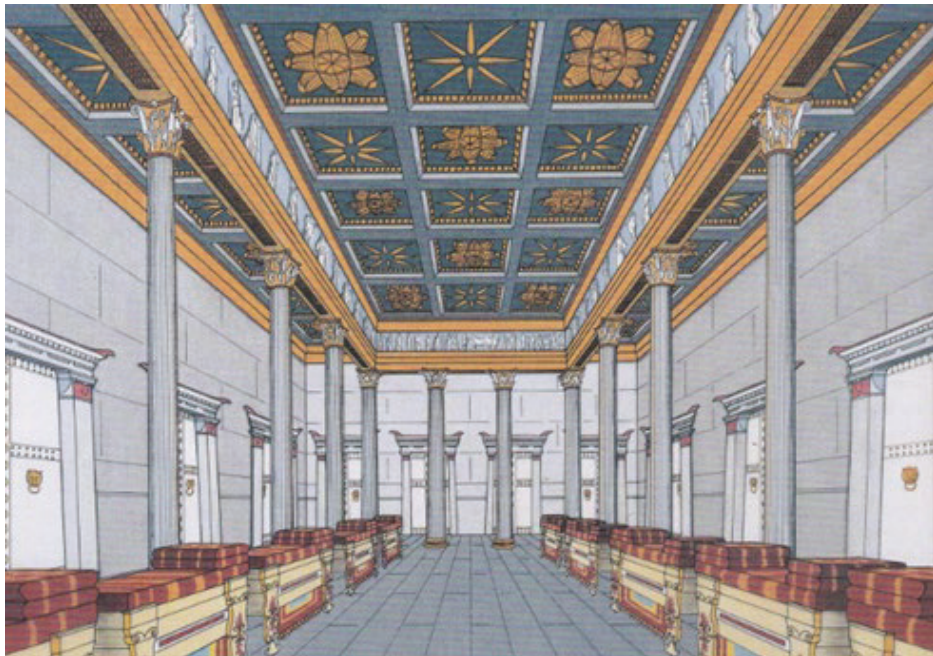

Figure 53. A reconstruction of the Dining Hall of the Thalamegos, lower floor (Pfrommer)

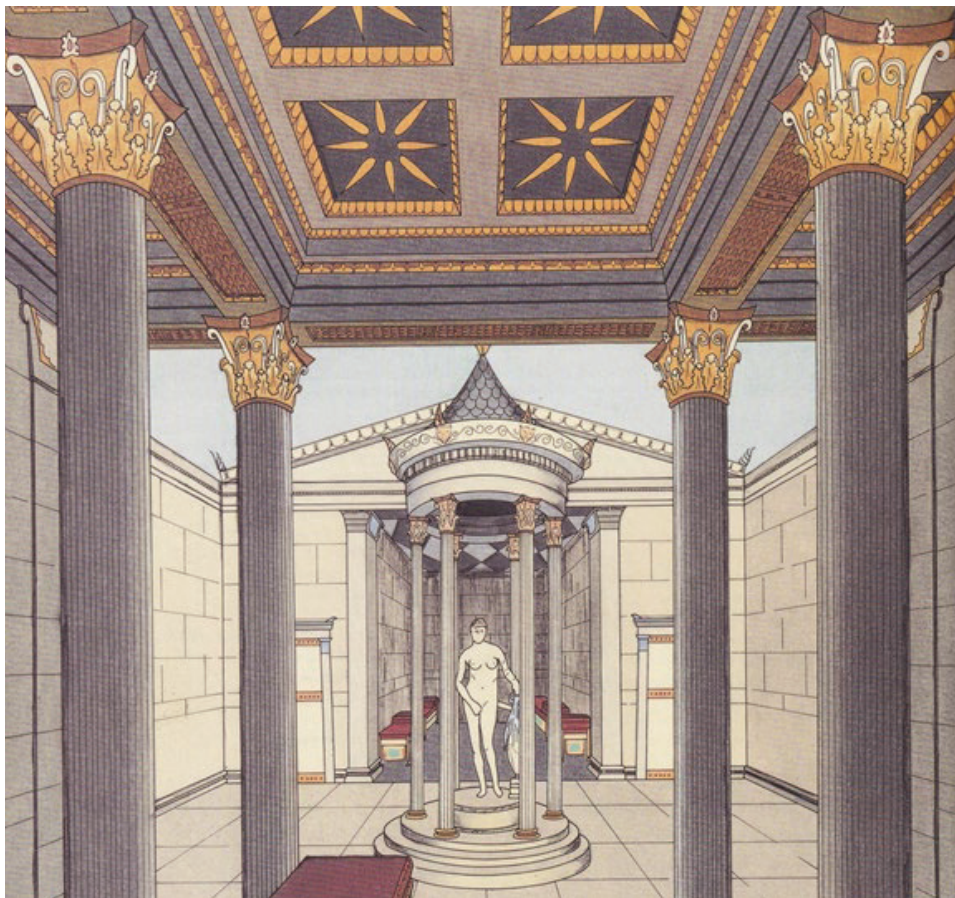

Figure 54. A reconstruction of the Shrine of Aphrodite at the top of the Thalamegos (Pfrommer)

Corinthian, Corinthianized, and Blocked-Out Capitals from the Ptolemaic and Nabataean Kingdoms

Aside from Alexandria, the Ptolemaic influence had reached to Upper Egypt, North-Eastern Libya, Southern Jordan, and the Island of Samothrace in the Aegean Sea. Some territories were under direct influence, others acted as vessel states, and others were contemporary and under an indirect influence. However, the architecture of these territories was not an identical reflection of that of Alexandria.

One must highlight that the city of Hermopolis Magna (Ashmunein) is another important turning point in this study. Hermopolis is no less than Alexandria; however, it began to flourish in the Roman period. The architecture of this city will go parallel along that of Alexandria in the second and third chapters and how it reflects and affects other Roman/Byzantine cities.

*Examples of Ptolemaic Corinthian Capitals from Other Areas in Egypt*¹¹⁸

Hermopolis Magna

Under the Ptolemies, Hermopolis Magna (Al-Ashmunein) did not have great attention like it did in the Roman times. The only important construction in the city was the Ptolemaic Sanctuary. Like the Sarapeum of Alexandria, it was built by and dedicated to Ptolemy III.¹¹⁹ However, it was dedicated to the rural cult of the Ptolemaic kings and queens. This one was in honor of the ‘Sibling Gods’, Ptolemy III and his sister/wife Berenike.¹²⁰

The most ‘elegant’ and important building is probably the portico or the stoa building of the city. It consists of sixteen Corinthian capitals, including Figure 55. The design of these capitals is somehow an early-like design of the Corinthian capitals, as it resembles those of the 4th century BC, like those ‘from the Monument of Lycrates or the tholos of Epidaurus.’¹²¹

Figure 55: A Type I Corinthian capital from the stoa of Hermopolis. The capital has a unique shape and differs from the common Type I capitals from Alexandria. The kalathos is barrel-like. The upper part of the capital shows lower parts of the volutes in a water-plant-like design; concaved and without helices. The volutes of each side pair at the corner of the capital. The central helices are short. They are wrapped with a pair of cauliculi and calyces emerging directly from the acanthus collar. Each calyx has a smaller cauliculus with a smaller calyx growing from it and wrapping around the helices. Both pairs are fluted. The fleuron is placed directly under the abacus. Its stem emerges directly from the central leaf of the upper row of the acanthus collar. The leaves of the fleuron grow only downwards from the petal, while the top is a kalathos-like leaf. From the petal grows two simplified cauliculi with a double-leaf calyx, each on one side. From each calyx grows a lesser helix towards the corner volute. The lower part of the capital shows the double acanthus collar. The leaves of the lower row consist of triple sets of leaflets with semi-closed, round sinuses. The upper row has leaves with double sets of leaflets with the same design of sinuses.



Figure 55. A Type I Alexandrian Corinthian Capital from the Sanctuary at Hermopolis Magna, Graeco-Roman Museum (McKenzie)

¹¹⁸ See cat. no. 60-72.

¹¹⁹ Wace, Megaw & Skeat 1959: 4, 5.

¹²⁰ McKenzie 2007: 56.

¹²¹ Wace, Megaw & Skeat 1959: 8; see p. 10 & 13; Figures 2, 7.

Edfu

The city of Apollinopolis Magna or Edfu in Aswan was an important city since the Old Kingdom. It became an important trading center in the Ptolemaic period, a site for a Roman fort in the Roman period and hosted a garrison in the Byzantine period.

The highlight of the city is the Ptolemaic temple of Horus, the falcon god. It is located probably in the middle of the ancient town. The temple was rebuilt by several of the Ptolemaic kings, starting from 237 BC, the outer hypostyle hall was constructed under Ptolemy VIII in 140–124 BC and the ‘forecourt and pylon’ in 116–71 BC.¹²² This might be the most interesting building in Upper Egypt regarding the Ptolemaic period, since the Temple of Horus was designed using Types I, II and III.

Figure 56: This capital is a Type I Corinthian capital, adapting the free style of capitals from Alexandria of the convex volutes without cauliculi and water plants for volutes. It matches Figure 18 in all its decorations, except for the sinuses of the acanthus leaves between its leaflets – see above. In Figure 18 the sinuses are opened, while in this capital they are enclosed, with an almond-shape design.

Figure 57: This Type II fragment is an adaptation of the Alexandrian Style. It matches Figure 37 regarding the central cauliculus and calyx, and Figure 40 regarding the double non-fluted cauliculi of the volutes by the corners of the capital – see p. 39. However, regarding the latter, in Figure 40, the double fluted cauliculi are held by a single acanthus leaf, while in Figure 58, each cauliculi are held by an acanthus leaf itself, resulting in a pairing design by all elements of the corner.

Figure 58: A fragment of a Floral capital. The capital, since being dated between the late 3rd and early 2nd centuries AD, is highly assumable to be the prototype for the Floral capitals from Nabataea– see below p. 53; Figure 73-74. The volutes are replaced with vine leaves and grapes. What remains of the central decorations are heart-shaped vine leaves with floral motifs.



Figures 56-58. Alexandrian Corinthian Capital/fragments from Edfu, in-situ (Pensabene)

Figures 59A-B: A double Type III Alexandrian Corinthian capital. The left capital (Figure 59A) matches Figure 58 above. However, the other capital resembles Figure 61 from Dandara – see next. It is probable that this design of interlocking Type III capitals had not appeared in Alexandria, thus making it a free style adaptation from the artists of Edfu, creating a new design for this capital.¹²³ But, Interlocking helices had appeared in Alexandria within Type I capitals, which serve both purposes as being an adaptation, regarding the motif itself, and a free style motif by the local artists.

The other/right capital (Figure 59B) has a parallel corner volutes wrapped in cauliculi, which is opposite to the non-interlocking design. It is as if the artist had cross-mixed the two designs for Type III capitals

¹²² Bagnall & Rathbone (eds.) 2008: 227, 228, 230; McKenzie 2007: 130.

¹²³ Pensabene 1993: 378, cat. no. 296.

regarding few of their motifs. Also, by observing the double corner volutes, we can see that both capitals have their double cauliculi wrapped in vine motifs.



Figures 59A-B. A double Type III Alexandrian Corinthian Capital from Edfu, in-situ (Pensabene)

Dandara

The city of Dandara in Qena has been famous throughout both the Pharaonic and Ptolemaic eras. However, it became more famous in the late phase of the Ptolemaic period for its temple of the goddess Hathor. There is a depiction of Ptolemy XV Caesarion and his mother Cleopatra VII on the external walls of the temple. The construction of the temple was held between 125 BC and AD 60. The temple of Hathor in Dandara has an architectural relation with that of Horus in Edfu regarding the main temple.¹²⁴

Although most of the capitals from Dandara are dated to the Roman period, there is one capital that can be attributed to the Ptolemaic period. It is probable that this capital was from an earlier construction of the temple of Hathor, which was later reconstructed in the same manner in the Roman period.

Figure 60: A Type I Corinthian executed in the manner of the Epidauran capital. Although being of the Type I category, there are slight differences from the Alexandrian and Epidauran designs. Between the central helices – and rising from the acanthus collar – are two X-shaped stems, emerging and reaching towards the abacus and the corner volutes. They extend above the helices and end with a lesser fleuron each.¹²⁵ This type of capitals will appear on Dandara frequently under Augustus with both identical and slightly different imitations – see p. 120-1, Figure 255; and p. 57-60, Figures 90-94.

Figures 61-62: Both indicate the usage of **Type III** capitals. They were executed in the two helices design of the Alexandrian style. Figure 62 shows the normal back-to-back helices with their stems separated. Figure 61 shows the central helices with interlocking stems and the double fluted volutes by the corner of the capital.¹²⁶

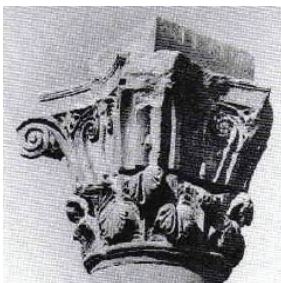

Figures 60-62. Alexandrian Corinthian Capitals from Dandara, in-situ (Pensabene)

¹²⁴ Bagnall & Rathbone (eds.) 2008: 209, 211 & 212.

¹²⁵ Ronczewski 1927: 10; Pensabene 1993: 362, cat. no. 223.

¹²⁶ Pensabene 1993: 372, 373, cat. no. 269, 273.

Kom Ombo

The town of Kom Ombo hosts a temple complex dedicated to both Sobek and Horus the Elder (known as Haroeris). The temple was built originally under Ptolemy VI Philometor, extended under Ptolemy XII but was finished in the 3rd century AD.¹²⁷

Figure 63: The capital is an adaptation of the standard Type III Alexandrian, like Figure 59a from Edfu and Figure 42 from Type III Alexandrian Corinthian capitals – see p. 40. We can also see traces of the central fleuron's stem between the helices, and a small calyx on a very thin and reduced cauliculus emerging from the acanthus collar.



Figure 63. Alexandrian Corinthian Capitals from Kom Ombo, in-situ (Pensabene)

Ptolemaic-Influenced Corinthian Capitals outside of Egypt

Palazzo delle Colonne in Ptolemais, Cyrenaica

Palazzo delle Colonne or Palace of the Columns was constructed somewhere in the 2nd or 1st century BC in Ptolemais, Cyrenaica under either Ptolemy VIII or Ptolemy IX. The palace was decorated with Type IV Alexandrian Corinthian and several Type I Alexandrian Corinthian capitals. The façade was decorated with the Type I capitals.¹²⁸

Figure 64: A Type I Corinthian capital. The capital is in a perfect condition. The helices and volutes emerge directly from the acanthus collar. The volutes rise over the helices and they are of water plants and are supported by S-shaped acanthus leaves; each at a corner of the capital. The helices are convex with a deep groove in the middle of their stems towards the abacus, then wrapped with very small calyces. The fleuron is oversized and is placed directly above the abacus. There are two lesser fleuron placed between the helices and the volutes. The acanthus collar is of double rows. Each leaf consists of triple sets of leaflets with fleur-de-lis endings. The sinuses and almond shaped and opened.



Figure 64. Alexandrian Corinthian Pilaster from Ptolemais, Palazzo delle colonne (Pensabene)

Several variations of the Type I Alexandrian Corinthian capitals were used throughout the palace. Within the several sections of the palace, the small oecus hosted several designs of Corinthian capitals as pilasters, half columns and free-standing columns. The architectural design was used within the Pompeian Second-Style Wall Painting – see p. 71-2; hence reflected the Alexandrian style in Pompeii through the Palazzo delle Colonne (Figures 65–67). These capitals reflect the traditional Alexandrian style, where they follow the Type I Alexandrian style of having cauliculi-wrapped volutes (Figure 65) or water plant volutes (Figure 66). They are decorated with vine leaves (Figure 65) or standard acanthi (Figure 66). Also, Figure 65 shows interlocking helices; an Alexandrian feature. Figure 66 shows concaved volutes, emerging from behind two vertical acanthi, who act as cauliculi.¹²⁹ Also, Figure 65 resembles Figure 42 from Alexandria, with both helices in lyriiform and emerging from the same acanthus leaf and the vine-designed leaves of the lower collar.

Interestingly, the free-standing columns were decorated with unusual capitals. Figure 67 shows features that will be later adapted within the Italo-Hellenistic capitals from Sicily and Southern Italy; i.e. Pompeii. Both Figures 66 and 67 show a large, six-petal fleuron; one of the distinguishing features of the Italo-Corinthian capitals Figure 67 has its fleuron at the center of the abacus, which is the standard positioning for the Italo-Hellenistic capitals – see p. 63-7.

¹²⁷ Bagnall & Rathbone (eds.) 2008: 232 & 233; McKenzie 2007: 131.

¹²⁸ McKenzie 2007: 95.

¹²⁹ Rekowski 2020: 157 – 160, 163, 265, 166.



Figure 65-67. Alexandrian Corinthian capitals from Ptolemais, Palazzo delle colonne (Pensabene)

Iraq El-Amir, Jordan

Qasr Al-Abd or 'Palace of the Slave' was built by Hyrcanus in the early 2nd century BC in Iraq El-Amir in modern-day Jordan. Since Hyrcanus was an ally to the Ptolemies, he was affected both politically and culturally. The palace was designed using Type II and Type III Alexandrian Corinthian capitals.¹³⁰

Figure 68: The Type III capital from Qasr Al-Abd shows the Ptolemaic influence, but rather with slight differences. The acanthus leaves form a double collar; however the design of the leaves is unlike the Alexandrian one, or even the Epidauran. The design of the leaf takes the shape of a beehive with no sinuses between the leaflets. The latter is formed of triple endings but not the fleur-de-lis design, and with visible leaf stems. The volutes are of water leaves normally. The fleuron is placed directly on the abacus, limited by its height. Its stem emerges directly from the acanthus collar as a straight line towards the abacus. However, the central helices are rather a bit strange. The cauliculi and their calyces resemble those of Hermopolis, regarding the design, but adapt the Type III Alexandrian separation by their base. The helices themselves are thin and small like the helices from the Anatolian Didymaion, and far from close to the Alexandrian style.

Figure 69: It shows three Type II capitals; a capital, a pilaster and the acanthus collar of a capital, probably of the same design. Strangely, These Type II capitals are very Alexandrian in their design. Unlike the Type III capitals, the design of these capitals was adapted without imposing any changes. The acanthus collar is formed of S-shaped leaves with triple fleur-de-lis leaflets and open sinuses. The volutes are water plants. The helices emerge from the same cauliculus and calyx. It is assumable that these Type II capitals were probably carved by an Alexandrian artisan, while the Type III capitals were either done by a local craftsman or carved as free style capitals.



Figure 68. (left) A reconstruction of an Alexandrian Corinthian capital from Iraq El-Amir (McKenzie)



Figure 69. (right) An Alexandrian Corinthian capital, upper level of the southern façade, Iraq El-Amir (universis.art)¹³¹

¹³⁰ McKenzie 2007: 95.

¹³¹ <https://universes.art/en/art-destinations/jordan/iraq-al-amir/qasr-al-abd/corinthian-capitals>

Sanctuary of the Gods, Island of Samothrace

Like King Antiochus IV, but actually prior to him, Ptolemy II had made contributions in the Hellenic realm of Greece, precisely at the fourth-century-BC Sanctuary of the Gods on the Island of Samothrace. The reason behind this is ambiguous; however it might be a continuation of the work done by the Macedonian Governor Lysimachus. It was Lysimachus who built a Rotunda for his daughter Arsinoe before marrying her to Ptolemy II, making her Arsinoe II of Egypt. The Rotunda was built in the early 3rd century BC, and then later followed by the construction of the Propylon of Ptolemy II.

The tower-like construction by Lysimachus was constructed as a Rotunda for his daughter Arsinoe (Figures 70-71). It was built between 289 and 281 BC as the first ever Corinthian building constructed on the island of Samothrace. The interior of the Rotunda (Figure 71) is decorated with semi-column Corinthian capitals. Interestingly, there are many similarities between the Corinthian capitals of the Rotunda and the capitals from the temples of Athena Alea at Tegea and/or of Zeus at Nemea; see figures 5-6.¹³²

Figure 70: The Type I capitals from the Rotunda of Arsinoe resemble much of the Epidauran and Philippeon capitals, but with further developments. The acanthus leaves are from the latter; five sets of leaflets with opened sinuses. The volutes and helices are very much Epidauran, but they are wrapped with cauliculi and calyces, of which the calyces resemble those from Hermopolis. The fleuron is a copy of the Epidauran one, regarding design and position, on the lower lip of the abacus and the top of the bell. The stem of the fleuron emerges directly from the acanthus collar as a straight line – see the Propylon of Ptolemy II, Figure 72.

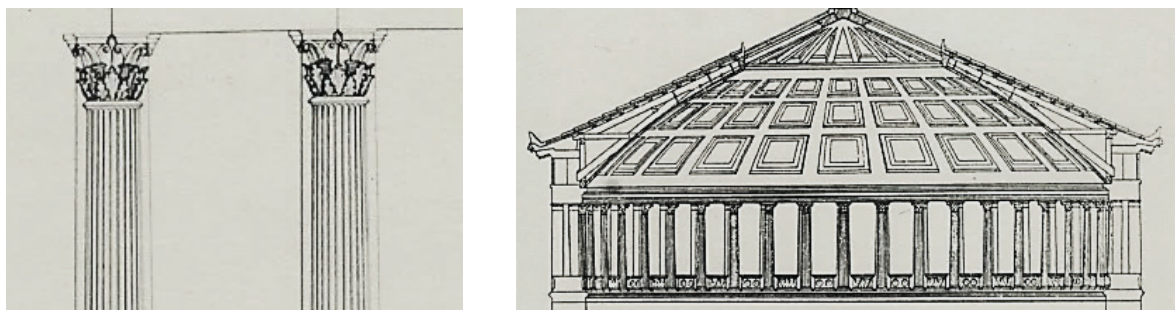

Figures 70-71. A reconstruction of the Rotunda of Arsinoe (Oberleitner)¹³³

The Propylon of Ptolemy II was built between 285 BC and 281 BC; probably a couple of years after the Rotunda of Arsinoe II. The design was probably adapted from the Northern Propylon of Epidaurus.¹³⁴ It was constructed as the gateway that leads inside the Sanctuary of Samothrace. Like the Propylon of Athens, it was constructed using dual orders; Ionic order on the exterior/eastern façade and Corinthian on the interior/western façade.¹³⁵

Figure 72: The capital used for the Propylon of Ptolemy II is as close as an adaptation of the capital used for the Rotunda of Arsinoe II. The only two differences resemble in the middle leaf emerging from being the central leaf from the upper collar. Also, the type of leaves used seems to be vine rather than acanthus leaves. They are carved of triple sets of leaflets with five endings. The fleuron is rather different and larger than the one from the Rotunda.

¹³² Frazer 1982: 191, 197 – 201.

¹³³ Oberleitner 1978: 140, Figure 129.

¹³⁴ Frazer 1921: 199, 201.

¹³⁵ Maniatis et al. 2012: 272.

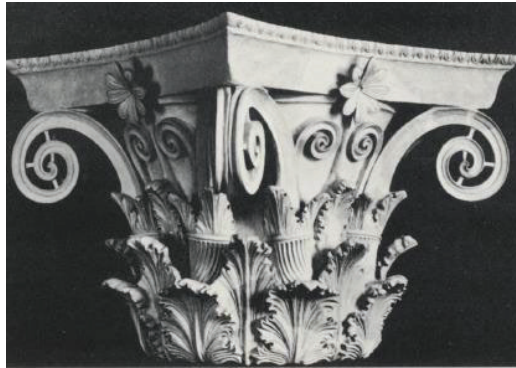

Figure 72. A digital reconstruction of the Corinthian capitals design from the Propylon of Ptolemy II, Sanctuary of the Gods, Samothrace (Maniatis)

The Antiochean Question: The Zeus Olympius Capital as an Indirect Ptolemaic Influence

Therefore, and as discussed earlier in this chapter, the capital from the Athenian temple of Zeus Olympius has a Seleuco-Epidauran influence; there is also another indirect influence from Alexandria. Accordingly, and since the Propylon of Ptolemy II predates the Antiochean design of the Corinthian capital of the Temple of Zeus Olympius, and since Samothrace is close to Anatolia and Macedonia – considering the latter to be the origin of post-Alexander architecture, we could partly add another point in answering the Antiochean question earlier mentioned in this chapter, that the Alexandrian architecture had its influence on Antiochus IV, but it might rather be an indirect influence – through the Propylon of Samothrace – rather than a direct one, which could be a possibility as well.

Petra and the Rise of the Nabataean and Floral Capitals

In order to understand how Petra became influenced by Alexandrian architecture, one must understand the relation between the Nabataean and the Ptolemaic Kingdoms, and in turn, the relation between the Ptolemaic Kingdom and Herod the Great, king of Judaea, who was the first to characterize and modify the Ptolemaic architectural culture into Judaea and the Transjordan region.¹³⁶ If the relation with the region of Iraq Al-Amir was political, then the relation with the Nabataean Kingdom was merely economical.

The Nabataean Kingdom (Southern Jordan and North of the Arabian Peninsula) was a wealthy country, known for its monopoly for incense oils, in regards to trading with Alexandria. The nation became recognizable between the 1st century BC and the 1st century AD. Due to trade routes created between the Ptolemaic and the Nabataean Kingdoms, the Ptolemaic Kingdom had architectural influences over the Nabataeans.

The Nabataeans had adopted various designs of the Alexandrian capitals: Types I, II and IV. Regarding Type I capitals, they were known as ‘Floral capitals’, and since Type I capitals were still regarded as ‘Free’ capitals rather than ‘Normal’ or ‘Orthodox’, which emerged with Roman imperialism. The Nabataeans had adapted the usage of Corinthian capitals regarding façades, *tholoi*, and most curiously the placement of a large Corinthian capital as the top of the pediment's façade or the *tholos*, holding an urn.¹³⁷

The Nabataean capitals are derived from the Alexandrian capitals as follows: Type I Nabataean and Type II Nabataean, which are both ‘blocked-out’ and the Floral capitals. Type I Nabataean is the blocked-out version of the Floral capital, and by observation, we can conclude that Type II Nabataean is the blocked-out version of Type IV. The blocked-out capitals are simply an outline design of the adapted Alexandrian capitals without

¹³⁶ Peleg-Barkat 2014: 142.

¹³⁷ McKenzie 2007: 96–97

any details or decorations. However, researchers had come to a conclusion that Nabataean capitals are a term that should be used for blocked-out capitals found on Nabataean sites only.

Type I Floral Capitals

This type of capitals consists of two blocks; the lower block is carved to form the acanthus collar, while the upper block is carved to form the corner volutes and the central floral motifs. The design of this capital is not a Nabataean invention, but rather a development of a development. It was adapted from a similar capital found in Edfu (Figure 58) – see Edfu, p. 47 – on a building with Type I Floral and Type III Floral capitals, dated to the 2nd or 1st centuries BC. Futuristic influences will appear in Italy and Iberia – see p. 94-98.



Figure 73. A reconstruction of the Type I Floral Corinthian capital design from El-Khazneh, Petra (McKenzie)

The Type I Floral capital (Figure 73), like the capital from Edfu (Figure 58), ‘has vegetal decoration with flowers, used in the same way as the decoration on the Type I floral capitals of Petra.’ The capital of Edfu is a decorative adaptation from the Type III Alexandrian capital, where both the Edfu and Petra capitals have vine leaves motifs, and the latter has grapes hanging off the volutes. Regarding capitals from the Nabataean Kingdom, Type I Floral capitals were presented in Petra, on both the Khazneh and the Temple of the Winged Lions.¹³⁸

Regarding El-Khazneh, the most famous monument in Petra, it was built c. late 1st century BC. Regardless the building itself, the façade is a combination of Alexandrian features and Nabataean modifications of Ptolemaic architecture. The façade consists of two levels; the first level is supported by Type I Floral capitals, while the upper is supported by Type II Floral supporting the pediment and the tholos – see Type II Floral below, p. 54.¹³⁹

Figure 74: Like all the capitals supporting the lower level of the Khazneh, this capital is an example of the Type I Floral capital. The lower part of the capital consists of a double acanthus collar with S-shaped leaves. Each leaf consists of three leaflets with three endings and opened sinuses. The upper part of the capital consists of corner volutes only, with quad-central floral decorations in the middle. The volutes are supported by large acanthus leaves emerging from the collar; each corner is supported with one leaf. Helices, with their cauliculi, calyces and the fleuron stem were omitted and replaced with the vine motifs. The Fleuron is placed directly on the abacus.

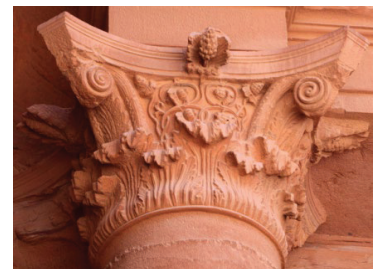

Figure 74. A Type I Floral Corinthian capital from El-Khazneh, Petra (eveandersson)*

The Temple of Winged Lions, dated to c. the first quarter of the 2nd century AD;¹⁴⁰ however, offers two additional designs of the Type I Floral capitals: Type I.A and Type I.B These two types match the exact decoration of a double drum, corner volutes and vine decorations in the middle. The different lies regarding the design of the corner volutes. The Khazneh, as explained above, offered corner volutes supported by an acanthus leaf.

Type I.A capital (Figure 75) from the Temple shows the Floral capitals of being wrapped with tiny vine leaves, which replaces the Alexandrian fluted helices, but matches the vine-wrapped volutes from Edfu – see Figure

¹³⁸ McKenzie 2001: 97–100, Figure 9; where in p. 99, it is based on the research of Wright, see Wright G.R.H. 1959-60. *Palestine Exploration Quarterly* 93: 124.

¹³⁹ McKenzie 2007: 96 & 97.

¹⁴⁰ Tuttle 2013: 10

* <https://www.eveandersson.com/photo-display/large/jordan/petra-al-khazneh-treasury-pillar-with-pine-cone.html>

58-59A/B above. The vine wrapping is coiled with a decorative band, and also supported with a tall acanthus leaf like that of El- Khazneh.¹⁴¹ This type was commonly more used.

However, Type I.B capital (Figure 76) was less commonly used than Type I.A. It was also presented in the Temple of Winged Lions. The difference between this type and Type I.A is that the corner volutes are much closer in design to the Alexandrian types than it is to Type I.A. The corners of the capitals are formed of triple sets of fluted cauliculi/calyx. Each cauliculus has a calyx ending, which is also fluted and is presented as an extension of the cauliculus, rather than being presented as a floral cup separated from the cauliculus with a base and a rim.¹⁴² The calyx endings themselves resemble the design of the acanthus leaflets of both the three and five triangular teeth-like endings.

Another capital (figure 77) from Petra bares a great resemblance of a Type III Alexandrian capital with interlocking helices. This capital is almost an adaptation of the façade's capital from Palazzo delle Colonne from Ptolemais.¹⁴³ The double acanthus collar and even the interlocking Type III helices are very Alexandrian in their essence – see above Type III capitals in Alexandria, Figure 59b from Edfu and Figure 61 from Dandara.



Figure 75. (left) An upper fragment of a Type I (I.A) Floral Corinthian capital, Temple of Winged Lions, Petra (Hammoud)

Figure 76. (middle) An upper fragment of a Type I (I.B) Floral Corinthian capital, Temple of Winged Lions, Petra (Hammoud)

Figure 77. (right) A Floral, Type III Alexandrian Corinthian capital, Petra (Hammoud)

Did the Nabataean artists go as far as Ptolemais or this ‘free’ design was familiar to the Egyptian artists that they copied into Petra? Were these Type III Alexandrian capitals familiar in Petra? Did Alexandrian architects work in Nabataea? These questions are worth answering with deeper studies regarding Nabataean architecture.

Type II Floral Capitals

Type II Floral capitals (Figure 78) can be easily traced back to Type IV Alexandrian Corinthian capitals, which themselves are traced back to the Double Volute capital from Olympia. The most notable example regarding this type is the Khanzeh from Petra. Since the lower level of the façade was supported by Type I Floral capitals, the broken pediment, the tholos and the urn-holding capital of the upper level were supported by Type II Floral capitals.¹⁴⁴

Like the Type IV Alexandrian capitals, the Type II Floral capital, from El-Khazneh’s upper level, (Figure 79) is designed without an acanthus collar, only two acanthus leaves, where each leaf supports a volute by the corner of the capital. The volute takes the S-shaped design, only without the central, extending volutes, which are replaced with vine decorations, like the Type I Floral capitals.

¹⁴¹ Hammoud 1977: 47.

¹⁴² Hammoud 1977: 50.

¹⁴³ Schmid 2012: 92.

¹⁴⁴ McKenzie 2007: 97, 99.

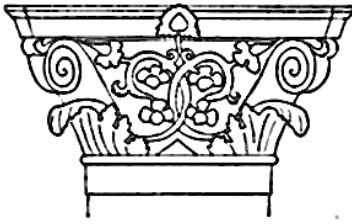

Figure 78. (left) Reconstruction of Type II Floral Corinthian capital (McKenzie)

Figure 79. (right) A Type II Floral Corinthian capital, El-Khazneh, Petra (McKenzie)

Type I and Type II Nabataean (blocked-out) Capitals

The Type I Nabataean capital (Figure 80) is a blocked-out or simplified version of the Type I Floral capital, where only the outline is preserved, with all the decorative motifs removed. The outline of the blocked-out capitals is sharp, showing the abacus sides by the ends of the capital and a double rim/belt in replacement to the double acanthus collar. The fleuron is replaced with a block in its place. This design of capitals was known throughout the Nabataean Kingdom, like Petra, and El-Hijr (Madaa'in Saleh).

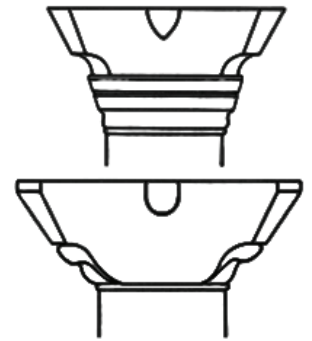

Figure 80. (upper) Type I Nabataean Corinthian capital;
Figure 81. (lower) Type II Nabataean Corinthian capital (McKenzie)

As for Type II Nabataean (Figure 81), it is a blocked-out or simplified version of both Type II Floral capital and the Type IV Alexandrian Corinthian capital. The outline of the capital shows the endings of the abacus, the central fleuron and, additionally from Type I Nabataean, the outline of the corner supporting leaves. The outline is smoother and with curves, unlike Type I Nabataean outline.

Like the Khazneh, a greatly celebrated monument is El-Deir (Figure 82) or 'the Monastery.' This tomb was executed in the same manner like the Khazneh. However, the capitals of El-Deir were blocked-out, simplified, curved capitals with fleuron rather than Floral capitals. The lower entablature is supported by Type II Nabataean capitals, while the broken pediment and the central tholos are supported by Type I Nabataean capitals.¹⁴⁵



Figure 82. Upper level of Al-Deir "The Monastery" in Petra (Wikipedia)¹⁴⁶

Near the modern town of Wadi Mousa, and overlooking the site of Wadi Matahah in Jordan, is a site of huge architectural debris. The blocks found in situ are drums and capitals from, probably, several courtyards of the peristyle type. This is a possibility of the previous presence of an architectural complex of two stories, due to

¹⁴⁵ Kennedy 1924: 290, 292.

¹⁴⁶ https://en.wikipedia.org/wiki/Ad_Deir#/media/File:Al_Deir_Petra.JPG

the variety of sizes of the drums. Figure 83 is a small Type I Nabataean capital, probably from the second storey of the mentioned complex.¹⁴⁷

In Tayma, NW of the Arab Peninsula, excavations had unearthed a building, probably a temple, in north-east of the oasis. Figure 83 is a Type II Nabataean capital from the site.¹⁴⁸ It is also worth noting that Tomb 3 in Fort Saleh in Gabbari district, Alexandria, has a Type IV (similar to Type II Nabataean) blocked-out capital, supporting the entablature.¹⁴⁹

One of the most hailed sites regarding the Nabataean culture is Hegra or Al-Hijr, known as Mada'in Saleh, which lies to the south of Petra, about 500km in the north of the Hijaz. It is famous for its rock-cut tombs that are similar to those of Petra.¹⁵⁰ Although the site of Mada'in Saleh has significant importance and is considered as a cornerstone for studying the Nabataean culture, it is important to discuss a couple of examples that have strong reflection and resemblance of the Nabataean capitals.

Rock-cut Nabataean tombs, mostly, follow the same façade design. The façade is usually presented with two Nabataean capitals, either of Type I or Type II, holding the main pediment, followed by two lesser capitals holding a small entablature.

In Hegra, Tomb B-6 (Figure 84) and Tomb IGN 110 (Figure 88) known as Qasr Al-Farid are carved with Type I Nabataean (Figure 80) capitals. Tomb B-6's door pediment (Figure 84), Tomb B-5 (Figure 85), and Tomb B-7 (Figure 86) are carved with Type II Nabataean (Figure 81) capitals. Another well-known and well preserved tomb is Tomb IGN 100 (Figure 87), known as Jabal Al-Khuraymat, has both types of capitals. The main entablature supported by two main pilasters of Type II Nabataean capitals, while the upper entablature is supported by four Type I Nabataean capitals (Figure 87) with a single rim – in place of a single acanthus collar, unlike the double rim from Petra and Al-Deir.¹⁵¹



Figure 83. A Type I Nabataean Capital, near Wadi Mousa (Schmid)

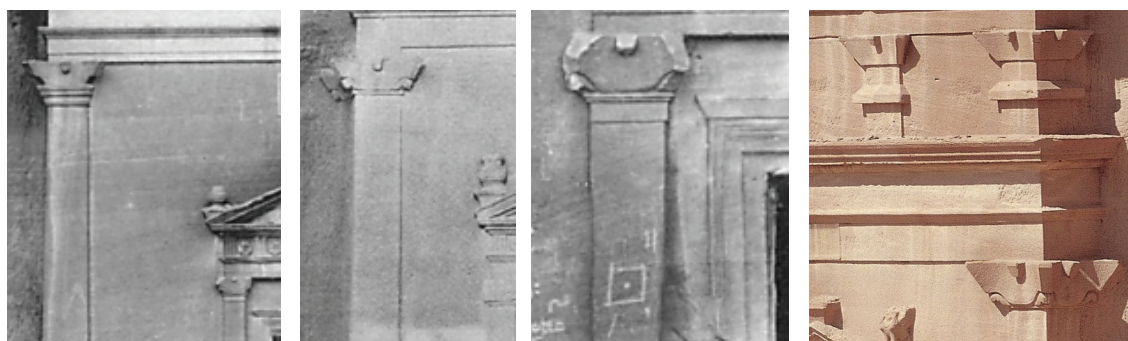

Figure 84. A Type I Nabataean (upper) and Type II Nabataean (lower/door's pediment) pilaster, Tomb B-6, Al-Hejrah (Madain Saleh)

Figure 85. (middle right) A Type II Nabataean pilaster, Tomb B-5, Al-Hejrah (Madain Saleh)

Figure 86. (middle left) A Type II Nabataean pilaster, Tomb B-7, Al-Hejrah (Madain Saleh)

Figure 87. A Type I Nabataean (upper) and Type II Nabataean (lower) pilasters, Tomb Tomb IGN 100, Al-Hejrah (Madain Saleh)

¹⁴⁷ Schmid 2012: 91, 92.

¹⁴⁸ Tourtet 2015: 388.

¹⁴⁹ McKenzie 2007: 87-88; Figure 139.

¹⁵⁰ Madain Saleh 2007: 20.

¹⁵¹ Anderson 2002: 172; Madain Saleh 2007: 26-27.



Figure 88. A Type I Nabataean pilaster, Tomb IG 110, Al-Hejrah (Madain Saleh)

The Nabataean and the Nabataean-like capitals remained to be used throughout the Roman period in both Egypt – like the Temple of Augustus at Philae (p. 100-1, Figure 193) – and Nabataea. This will be discussed in the following chapter.

The Egyptian Composite Capitals

The interaction between the Greek and the existing Ancient Egyptian culture was both ways. As we have seen above how the Egyptian influence had appeared on Corinthian capitals in both Type I (Figure 89) and Type II (Figure 90) capitals, it appears that the Ptolemaic kings were keen on preserving and constructing new temples using the ancient Egyptian architectural style, especially in Upper Egypt. This was to keep peace with the Egyptians and assume the role of the deified pharaohs.

The existence of Composite capitals, generally, in Egypt had probably began with the Saite Dynasty and extended during the Achaemenid Dynasty. The practice took another turn around the 2nd century BC, under Ptolemy VIII. Although there are varieties of designs regarding the Composite capitals, this research is only concerned with the Greek-influenced capitals, and another type which I shall be discussing in the next chapter.

It is notable that the Egyptian Composite capitals are either influenced by having central helices only or acanthus collar and small volutes, but never the two designs combined together. The acanthus collars are of three (Figure 89) or five rows (Figure 90), unlike the single and double rows from the Corinthian capitals. Also, a common feature for all Ptolemaic Egyptian capitals is that Dynastic capitals were round and similar on all sides, while the Ptolemaic ones adapted the Corinthian feature of having four sides,¹⁵² save for the Alexandrian capital discussed below.

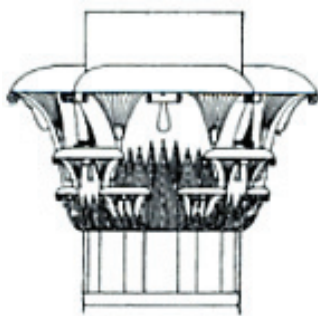

Figure 89. Type I Egyptian Composite Capital (McKenzie)

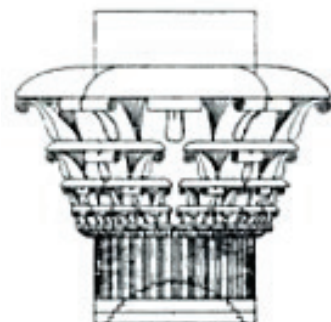

Figure 90. Type II Egyptian Composite Capital (McKenzie)

¹⁵² McKenzie 2007: 119, 121, 125, 127, 129, 135.

The definition of these types of capitals is based on how they are related to the 'Ionic-Corinthian combination' by the Egyptologists. These capitals do follow neither the Egyptian nor the Graeco-Roman arrangement of a unified design for the façade. Each capital could be different from the one next to it or two designs of capitals interchangeably.¹⁵³

Helix-Influenced Egyptian Composite Capitals

In Figure 91, the capital from Alexandria¹⁵⁴ is decorated with various Egyptian elements, including papyri flowered and lotus chalices that forms arch-like umbrella stems. However, on each of the three sides of the capital are a couple of central helices. Those helices resemble the design of Type I Alexandrian Corinthian capitals of the first subcategory; concave, *non-cauliculated* helices.¹⁵⁵ Egyptian Composite capitals from Upper Egypt are shown to have been of the volute-and-acanthus-influenced type only.



Figure 91. *An Egyptian Composite Capital from Alexandria, (Pensabene)*

Island of Philae

The Island of Philae had a great importance in both the Ptolemaic and Roman periods. The island was considered somehow to be holy for both kings and emperors from the two periods that construction processes on the island did not stop, probably until Diocletian.

The Temple of Hathor had the first clear and datable example of Composite capitals with volutes and acanthus collars. It was erected under Ptolemy VI Philometor in c. 157 BC.¹⁵⁶ The *pronaos* (Figure 92) is decorated with two capitals Egyptian Composite capitals with three rows of acanthus collars and small volutes.



Figure 92. *Egyptian Composite Capitals from the Temple of Hathor, Philae (C. Rozay)*¹⁵⁷

The *pronaos* of the Birth House (Figure 93) on Philae is also decorated with several capitals of different designs, including the same capitals used for the Temple of Hathor, as well as the five-row acanthus collar. It

¹⁵³ McKenzie 2007: 125.

¹⁵⁴ The capital was found at the site of Chantier Finney, Cricket Club, currently in the Graeco-Roman Museum, Alexandria; Pensabene 1993: 348, cat. no. 160.

¹⁵⁵ See above Type I Alexandrian Corinthian capitals, first subcategory, "b" subtitle, helices.

¹⁵⁶ McKenzie 2007: 395, note 39.

¹⁵⁷ <https://www.journeytoegypt.com/en/discover-egypt/philae-temple-aswan>

is dated whether the capitals were installed in the times of Ptolemy III to Ptolemy the V or in the expansion process carried out under Ptolemy VIII.¹⁵⁸



Figure 93. *Egyptian Composite Capitals from the pronaos of the Birth House, Philae (C. Rozay)*¹⁵⁹

The expansion of the Temple of Isis on Philae under Ptolemy VIII and Ptolemy XII¹⁶⁰ was carried out by the construction of the Second Eastern Colonnade (Figure 94) overlooking the courtyard before the temple. The colonnade is decorated also with many capitals of random arrangement, including the three-row and the five-row acanthus collars.¹⁶¹ The two far-right capitals appear to be incomplete or probably blocked-out; a technique adapted from the Type IV capital of Fort Saleh, and later in Nabataea.



Figure 94. *Egyptian Composite Capitals from the Second Eastern Colonnade, with the Temple of Isis in the background, Philae (Cannundrums)*¹⁶²

Edfu

The Temple of Horus in Edfu (Figure 95), which I partially discussed above regarding its Corinthian capitals, was also decorated with Egyptian Composite capitals. These capitals were used for the outer hypostyle hall (Figure 96), and the forecourt (Figure 97) under Ptolemy IX.¹⁶³

¹⁵⁸ McKenzie 2007: 129; p. 129; p. 395, note 42.

¹⁵⁹ <https://www.voyagevirtuel.co.uk/egypt/photo/assouan-philae-067.php>

¹⁶⁰ McKenzie 2007: 395, note 44.

¹⁶¹ McKenzie 2007: 129.

¹⁶² <http://cannundrum.blogspot.com/2015/06/temple-of-isis-on-philae-island-aswan.html>

¹⁶³ McKenzie 2007: 130, 131.



Figure 95. Egyptian Composite Capitals from the Hypostyle Hall and the Eastern Colonnade, Temple of Horus, Edfu (McKenzie)

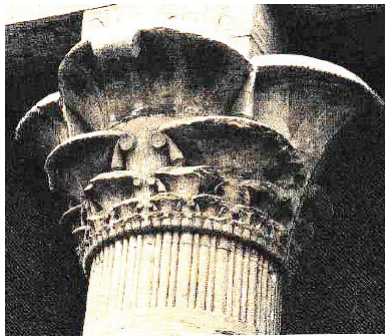

Figure 96. An Egyptian Composite Capital from the Outer Hypostyle Hall, Temple of Horus, Edfu (McKenzie)

Figure 97. An Egyptian Composite Capital from the Front Courtyard, Temple of Horus, Edfu (McKenzie)

Kom Ombo

The Temple of Haroeris and Sobek in Kom Ombo (Figure 98), which I also discussed regarding its Corinthian capitals, is preceded by a hypostyle hall, decorated with Composite capitals regarding its façade.¹⁶⁴ The temple is decorated with capitals of both three-row and five-row acanthus collar types; i.e. the outer hypostyle (Figure 99).



Figure 98. Temple of Haroeris and Sobek, Kom Ombo (Bagnall and Rathbone)

Figure 99. An Egyptian Composite Capital from the Outer Hypostyle, Temple of Haroeris and Sobek, Kom Ombo (McKenzie)

¹⁶⁴ McKenzie 2007: 131.

Therefore, after tracing the evolution of the Corinthian capitals throughout the Hellenistic age, we can conclude the following:

- The earliest Hellenistic Corinthian capital examples from the Hellenistic world, and how they served in the evolution of the Alexandrian capitals and modeling for the capitals of the Zeus Olympius.
- The derivation of the first three types of Alexandrian capitals came from the Epidauran capital, with differences regarding the orientation of the helices, and the fourth type from the Double Volute capital from Olympia.
- The analysis of the four Alexandrian types regarding certain masterpieces, special capitals, reduced and simplified capitals, and the analysis of each motif from each type.
- The evolution of the Alexandrian types of capitals within Alexandria and how they were adapted or slightly changed within the regions of Upper Egypt.
- The usage of Corinthian motifs within the local Egyptian types of capitals, the usage of Egyptian motifs within Alexandrian Corinthian capitals, and how both designs differed from the original Alexandrian ones.
- The Antiochean Question and the quest of the origin of the capitals from the Temple of Zeus Olympius in Athens, and how it was a fusion of Seleucid, Indo-Hellenistic and Ptolemaic influences; the latter through the capital from Samothrace.
- The expansion and usage of the Alexandrian Corinthian capitals with different motifs within territories outside Egypt, but under Ptolemaic influences.
- The Floral and Nabataean capitals, how they were derived from the Alexandrian Corinthian capitals, and to which extent they were adapted and altered.

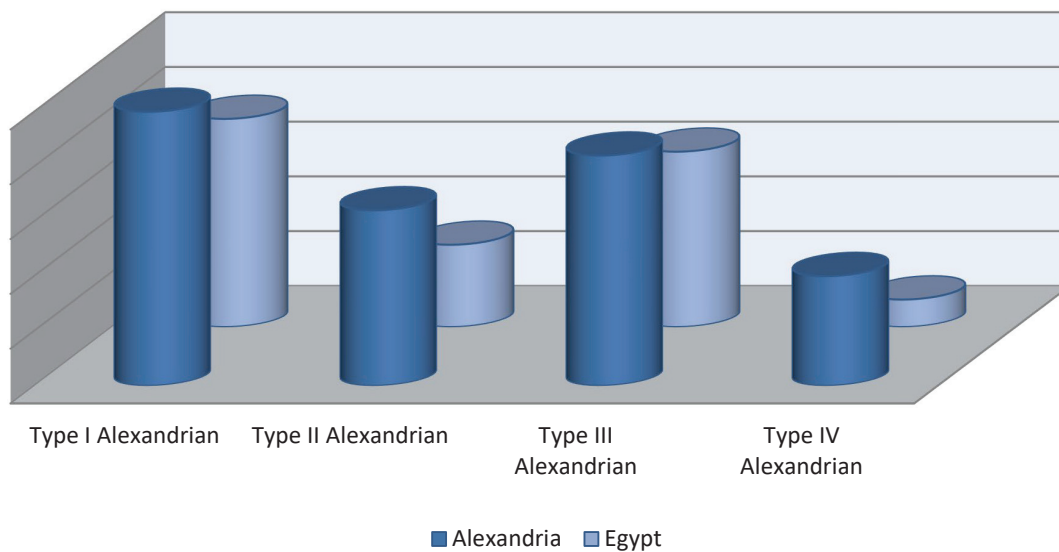

A chart showing the approximate usage of the four types of the Alexandrian Corinthian capital during the Ptolemaic Period in Alexandria, in contrast to Egypt (3rd century BC - c. 30 BC)

Chapter II

Italo-Hellenistic, Late Republican, and Roman Imperial Corinthian Capitals

After discussing the wide spread of the Corinthian order and the various designs of its capitals across the Hellenistic regions in the East, Corinthian capitals did also emerge separately or as a free style on the Italian Peninsula. On the one hand, the Italo-Hellenistic and Etrusco-Latin architecture had existed prior to the Romanization of the peninsula and the Roman expansion towards the east of Europe, and the expansion within the Italian Peninsula respectively.¹⁶⁵ On the other hand, the adaptation and spread of the Corinthian order in its form that will later appear under Augustus in Rome began to appear after Sulla's sacking of Athens – or so it was assumed, and its identification and adoption of the capitals from the Athenian temple of Zeus Olympius.¹⁶⁶ However, I shall be discussing below how the actual adaptation of the Corinthian capitals began, first, with the Italo-Hellenistic architecture, followed by the Roman conquests in the Eastern Mediterranean,

Therefore, the early existence of the Corinthian capital on the Italian Peninsula happened on two separate levels: the pre-Romanized Italo-Hellenistic/pre-Sullan style of capitals, and the Late Republican, post-Olympeion/triumphal capitals. By the reach of this point, the Corinthian capital was still in the period of being free in style and non-orthodox.

The orthodoxy of the Corinthian capital began with the rise of the Roman Empire under Augustus, and especially after the annexation of Egypt. However, the period of Augustus' rule is quite confusing for some archeologists. It seems that local architecture of the provinces was not highly affected by the Roman one during these early imperial years; thus leading into a period of uncertain categorization of capitals – i.e. like in Alexandria, where capitals are dated as "1st century BC – 1st century AD" and categorized as "late Ptolemaic or early Roman" – see below p. 97-101. This matter will be mainly and directly addressed in Egypt, with similar conception regarding the Levantine coast (Palmyra and Baalbek).

It was in the time of Augustus that Vitruvius wrote his famous book *De Architectura*. I had discussed the Vitruvian proportions and ratios in the introduction; an attempt to identify the capitals that inspired creation of the capitals from the temple of Zeus Olympius and if such proportions were applicable prior to the Vitruvian canon. It was this capital on which Vitruvius set his ratios regarding the Orthodoxy of the Corinthian capital.

Following the death of Augustus, and until the 3rd Century Crisis and the rise of Constantine the Great, the Roman empire had been more or less a unified power; thus with appliance to its architecture, the whole empire had adapted, also more or less, a unified system of architectural designs, reflected, in case of this study, on the Corinthian capitals. Also, around the time of Hadrian, a new type of Corinthian capitals introduced from Asia Minor, probably from Aphrodisias, had overcome the Augustan canonical type of capitals throughout the imperial provinces. These capitals had dominated in Rome as well as Egypt. Regarding the latter, these Asiatic capitals had almost replaced the Alexandrian and Egyptian types of capitals, as well as influencing in the creation of Late Antique capitals both from Constantinople or the local Egyptian workshops – see Chapter III.

The Corinthian capital underwent various stages of evolution. Like the great extending of Hellenistic World, the Roman World had covered the entire Mediterranean Sea, influenced by and influencing its people; from Mesopotamia to the Atlantic Ocean, and from the British Isles to the African deserts and the Cataracts of Egypt.

¹⁶⁵ Robertson 1929: 201 and 205; Winter 2005: 186.

¹⁶⁶ Abramson 1974: 8–22; Winter 2005: 196; Stamper 2014: 208.

This massive scale of land allowed the Corinthian order to develop throughout both related and separate phases, as follow:

- i. The Pre-Sullan, Italo-Hellenistic phase and how it influenced the various designs of the Corinthian capital across the Peninsula.
- ii. The theories related to Sulla, and the influence and relation of the Roman Corinthian capital design to the Athenian temple of Zeus Olympius.
- iii. Emperor Augustus and the rise of the canonical Roman Orthodox Corinthian capital in Rome, the Italian Peninsula and the imperial provinces.
- iv. Hellenistic architecture within the Eastern Roman Provinces (Greece, Asia Minor, and the Levant cities of Palmyra and Baalbek) between the 1st century BC and the 1st century AD.
- v. Alexandria and the Ptolemaic architectural influence over early Roman years, leading to a period of confusion regarding their origin – capitals dated between 1st century BC and 1st century AD.
- vi. The post-Augustan emperors and their contributions regarding the Corinthian order within Rome, the Italian Peninsula and the imperial provinces.
- vii. The rise of the Asiatic types of Corinthian capitals, and how they evolved in Rome and Egypt.
- viii. The city of Alexandria, Provincia Aegypti, and the evolution of the Corinthian order within the 1st and 2nd centuries AD, on the one hand, and the 3rd and 4th centuries AD on the other hand – the gradual change from the canonical capitals to the Asiatic and proto-Constantinopolitan ones.

Italo-Hellenistic and Roman Republican Corinthian Capitals – Examples from Rome and Italy

Although the range of studying the Italo-Hellenistic and Etrusco-Latin architecture is massive, the limited appearance of the Corinthian order in this period had made it easy for viewing and grouping various examples. These examples will have a reduced, yet visible influence in the following period, with the canonization of the Corinthian order.

The Late Republican period in regards of architecture was a period of architectural confusion and fusion of several Hellenistic period and architectural styles. In order to understand how the Corinthian order came to exist within Rome, one must understand how the Order found its way into the Italian Peninsula. Therefore, the Late Republican period should be divided as follows:

- i. The Italo-Hellenistic Corinthian capital styles from Magna Graecia in South Italy and Sicily, and their spread into the north of the Italian Peninsula.
- ii. Pompeii between receiving and reflecting Hellenistic Corinthian capitals through architecture and wall paintings.
- iii. The Island of Samothrace and the Hellenization of Rome through the military triumphal parades of Roman Generals and their reflection on Roman architecture (Rome's conquests in the Eastern Mediterranean region).
- iv. Rome's architecture in relation to Sulla's Sack of Athens (the theory of the Capitoline/Olympic Capital) until the demise of both the Republic and the Hellenistic world – Rise of Augustus.

Examples from the Reflection of Hellenistic Architecture in Southern Italy, Rome and the Italian Peninsula

Republican architecture is mostly attributed to the Etruscan style and its fusion with the rising Italic one. However, the earliest appearances of the Corinthian order were an influence of the Hellenistic period through the Phoenicians and the Carthaginians,¹⁶⁷ partially due to the presence of "Western Greek architects" in Southern Italy. Therefore, it was not strange to find the earliest of examples in the Magna Graecia and Sicily

¹⁶⁷ Robertson 1929: 204.

regions in Southern Italy and the "Naples-Pompeii area", for it was then, when the Corinthian order lost its purity to the Italic architecture.¹⁶⁸

Tempio della Pace, Paestum

The Temple of Peace in Paestum was a highly unorthodox, Doric-Corinthian temple regarding its design, reflected on its capitals. The temple is not purely Hellenistic, since it was affected by Etruscan architecture; i.e. the presence of anthropomorphic representations on the capitals¹⁶⁹. The temple was originally built after the Roman occupation of Paestum in 273 BC. The temple was built in contrast to the stiff Archaic Greek and Doric styles.¹⁷⁰

The capital (Figure 100) of this temple seems to be a fusion of several Corinthian capital styles. The corner volutes are "canted" and of massive size, concaved and seem to dominate most of the capital. They resemble the Type IV Alexandrian Corinthian capitals, since helices, cauliculi and calyces that fill the center of the capital are removed. However, and unlike Type IV Alexandrian, the capital is decorated with a single row of acanthus leaves, like the single capital from the Temple of Apollo at Bassae.¹⁷¹



Figure 100. A reconstruction of the Corinthian capital from the Tempio della Pace (Dinsmoor)

Several Examples of Italo-Hellenistic Corinthian Capitals: Appearance in Southern Italy and Sicily, and their Spread into Rome and the Rest of the Italian Peninsula

The origin of the Italo-Corinthian capital is unknown; however, its design is unique and can be easily identified. It appeared on Sicily between the 3rd and the 2nd centuries BC, highly probable to be adapted from the Alexandrian Corinthian capitals. McKenzie and Rekowski mentioned that appearance of similar capitals in the Palazzo delle Colonne in Ptolemais. Also, the same style of capitals was adapted in the Pompeian Second-Style Wall Painting – see p. 71ff. This style became widespread in the second half of the 2nd century BC throughout the Italian Peninsula.¹⁷² The works of Lauter-Bufe¹⁷³ and De Maria about the design of the Italo-Corinthian capital, which Lauter-Bufe renames as the Siculo-Corinthian capital, is reflected upon several examples from Sicily.

The essential features of the Siculo-Corinthian capitals are having an acanthus collar which consists of double rows and of eight leaves. Its height does not exceed half the total height of the capital. The leaves have curved, sharp endings; wide folds, midribs and side-ribs are thick and prominent; known as Italic acanthus. Both the helices and volutes emerge separately from the acanthus collar, and being convex in their design, as well as being surrounded by two freely-emerged acanthus leaves; an Italo-Corinthian feature. Cauliculi and helices are omitted. The double volutes are short, supported by the corners are supported with acanthus leaves, and have corkscrew, projecting endings. The helices emerge vertically. The acanthus leaves are neither sharp nor round, but rather flowery and hazy. The capital's side is decorated with a large sixfold fleuron, covering parts of the abacus, kalathos and central helices.¹⁷⁴ Also, the Italo-Corinthian capital ratios, based on the Sicilian design, do not follow the Vitruvian ratios. The height of the abacus is reduced into one eighth (1/8) of the total height rather than one seventh (1/7) of the standard height.

¹⁶⁸ Winter 2005: 30, 186, 187.

¹⁶⁹ Winter 2005: 234.

¹⁷⁰ Stamper 2005: 47.

¹⁷¹ Dinsmoor 1950: 279.

¹⁷² De Maria 1981: 575; also see abstract.

¹⁷³ See later as referred to by Gans, p. 65.

¹⁷⁴ Gans 1990: 691 and 692; De Maria 1981: 566–588, 575.

Most capitals of the Italo-Hellenistic styles found in Northern Italy were carved of a single drum; a distinguishable feature to this category of Corinthian capitals. Proportions of the capitals from the northern region has do major differences from the ones that originated in the south. The acanthus leaves of some capitals from the cisalpine capitals have lost the detailed decorations of the collar, there only the folded part is decorated, while the rest of the leaves are being floral and wavy, known as "soft acanthus."¹⁷⁵ However, we must consider the possibility of a stylistic drift both geographically and chronologically regarding the Corinthian capitals from the north especially that they appeared later than the ones from the south. The height of the acanthus leaves exceeds more than half of the total height in most of the cases.

The examples that match the description and examples by both Laute-Bufe – through Gans – and De Maria found in Sicily and across Italy, can be divided geographically from south to north. We can also divide them into two groups according to the artistic design. The Italo-Hellenistic Corinthian capitals of the central-southern region were common between c. end of the 2nd century BC and throughout the 1st century BC. They also predate the cisalpine examples. While in the Roman Cisalpine region, Researchers of Roman architecture in the north of the peninsula had come across several capitals related to the Italo-Corinthian style, dated to the Late Republican period of the 1st century BC.¹⁷⁶

Central-Southern Capitals (Sicily to Rome)¹⁷⁷

- Solanto's Antiquarium, Palermo, Sicily: A capital dated to the 2nd century BC, with soft acanthus leaf (Figure 101).
- Taranto, South Italy: A capital (Figure 102) dated to c. second half of the 2nd century BC.
- Porta Nocera cemetery, Pompeii: Although this incomplete capital (Figure 103) is divided into geometric zones, it is clear of being Corinthian in general – as explained by De Maria. The lower, smooth, convex ring resembles the folded acanthus leaves of the lower collar, while the central prominent blockade resembles the folded leaves of the upper collar. The uppermost, thick blockade was made the largest to allow the artist to carve the large helices and the central six-fold, large fleuron.

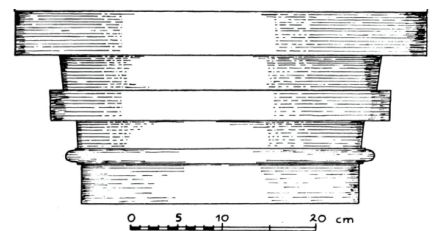

Figure 101. (left) A reconstruction of a Corinthian capital from Solanto (Jones)

Figure 102. (middle) A Corinthian capital from Taranto (Jones)

Figure 103. (right) A reconstruction of an incomplete Corinthian capital from Porta Nocera (Jones)

- Faenza, Ravenna: A capital (Figure 104) from a funerary monument.
- House of Augustus, Rome: The incomplete capital (Figure 105) was unearthed in the so-called House of Augustus on the Palatine Hill in Rome. It has a rough surface like the Italo-Corinthian capitals found in Pompeii, but in a more advanced carving technique. However, the carving is based on Republican

¹⁷⁵ De Maria 1977: 177.

¹⁷⁶ De Maria 1981: 603, 609, 610–612, 614

¹⁷⁷ De Maria 1977: 177 ; De Maria 1981: 571, 583, 591, 592; Jones 1991: 117, 118, 129, Appendix 3 in 145; Dally 2006: 135–140; pl. 19.

techniques. The abacus was already finished, as well as most of the volutes. The heights, folding and dimensions of the acanthus collar were outlined, as well as the radius of the fleuron. In contrast, another capital was unearthed from the same house; however, it was a complete one (Figure 106).



Figure 104. (left) A Corinthian capital from Ravenna (De Maria)

Figures 105 and 106. (middle and left) Two identical incomplete and complete Corinthian capitals from House of Augustus (Jones)

▪ Temple of Vesta, Tivoli:

The Temple of Vesta in Tivoli, built in c. 80 BC,¹⁷⁸ was also a temple-tholos.¹⁷⁹ The temple is more of an Italo-Corinthian temple than of being purely Hellenistic,¹⁸⁰ best described as "a Hellenistic intruder upon the Roman scene."¹⁸¹ The design is quite unique regarding the capitals (Figure 107).

The volutes are large, with prominent, corkscrew lobes.¹⁸² The double acanthus collar is of soft acanthus leaves.¹⁸³ The central fleuron of six petals was also large that it covered from the top of the abacus down towards the central leaf of the second acanthus row.¹⁸⁴ There are traces of helices' stems, but it seems like a shadow behind the fleuron. It was built of two blocks, where, if separated, each would show each a Greek or Anatolian style, like the Round Temple of Heracles Victor. Therefore, this temple is one of the late examples of the Italo-Hellenistic style from Southern Italy.¹⁸⁵ Also, the capital of the Temple of Vesta has strong resemblance with that from the Basilica and Tribunal from Pompeii's Forum – see p. 68-9.



Figure 107. A reconstruction of a Corinthian capital from the Temple of Vesta, Tivoli (Robertson)

Central-Northern Capitals (Rimini and the Cisalpine Cities)¹⁸⁶

- Rimini, Eastern Italy: A small, incomplete capital (Figure 108) 3rd–2nd century BC.
- Rimini, Eastern Italy: A capital (Figure 109) unearthed in San Lorenzo a Monte street; on display in Museo Civico. The capital is dated to the first two decades of the 1st century BC. Probably, the capital belonged to

¹⁷⁸ Strong 1978: 139.

¹⁷⁹ Sear 1982: 22.

¹⁸⁰ Stamper 2005: 75.

¹⁸¹ Böethius 1978: 139.

¹⁸² Roberson 1929: 210; Sear 1982: 62; Stamper 2005: 75.

¹⁸³ De Maria 1977: 177.

¹⁸⁴ Sear 1982: 62; Cruickshank 1996: 240.

¹⁸⁵ Roberson 1929: 210.

¹⁸⁶ De Maria 1977: 182, 183 note 54; De Maria 1981: 566–571, 573, 583, 592, 606–608, 612.

a sacred monument. This capital is more luxurious in its decoration, rather than the common models from the same Italo-Hellenistic category of capitals.

- Bologna: The capital (Figure 110) is characterized with stylistic stiffening. It is dated to the second half of the 1st century BC. The height of the acanthus collar is c. 1.58 of the total height.
- Verona: The leaves of the capital (Figure 111) are adapted from Pompeii.
- Milan: A two-drum capital. The capital (Figure 112) has great resemblance to the Sicilian category unlike any other cisalpine capital. The leaves are adapted from Pompeii. The height of the acanthus collar is c. 1.69m.
- Aquileia: A capital (Figure 113) on display in the Udine Museum. It is dated to the second half of the 1st century BC. It is characterized with stylistic stiffening. There is no central free acanthus leaf behind the helices. The height of the acanthus collar is c. 1.37m. The capital has resemblance to the Pompeian Corinthian capitals; i.e.: House of the Faun.



Figures 108-9. (left and middle) Two Corinthian capitals from Rimini (De Maria)

Figure 110. (right) A Corinthian capital from Bologna (De Maria)



Figure 111. (left) A Corinthian capital from Verona (De Maria)

Figure 112. (middle) A Corinthian capital from Milan (De Maria)

Figure 113. (right) A Corinthian capital from Aquileia (De Maria)

Non-Italo-Corinthian Capitals from Pompeii: Representations through Architecture and Wall-Paintings

Although Pompeii is considered one of the most important sites in Southern Italy, it was not only a reflection of Hellenistic styles, but also Roman and Alexandrian ones. Pompeii had witnessed the Hellenistic styles from Greece and Asia Minor, as part of the Magna Graecia region. Also, Alexandrian architecture was reflected through the Second Style – as wall paintings rather than actual architectural decorations. By the time of Sulla and the Romanization of Southern Italy, Pompeii was exposed to the newly Hellenized Roman architecture under both Sulla and the previously influential triumphal period.

Pompeii's Forum

Temple of Jupiter

It is probably an earlier version of the Roman Capitolium¹⁸⁷ (see below for Theory I in relation to the Roman Capitolium, p. 78ff), erected in the North-West of Pompeii's Forum, c. 110 BC. It was dedicated to Jupiter, Juno and Minerva, during the Samnite period. It was rebuilt again under Sulla during the Romanization of Campagna. There are no traces of the capitals from the Samnite Capitolium. However, the ruins of the present Capitolium were the one founded by Sulla.¹⁸⁸ The temple was decorated with six Corinthian columns of the Italo-Hellenistic style, holding the pediment.¹⁸⁹ We can see a depiction of a probably surviving capital, presented by Margarete Gütschow (Figure 114).

The acanthus collar is of double rows, with elongated leaves. The leaves of the lower row are of triple sets with six sharp, long, leaflet endings. The upper row has a visible pair of five leaflet endings. The cauliculi and wide by the top, with a thin rim, are reduced in width by the base. The calyces are wide and acanthized, growing up to support the helix emerging from it. The helices are flattened, non-hollowed, extending towards the lower lip of the abacus, with a triangular prominence. The fleuron has five leaflets, placed on the abacus, with a thick stem emerging from the acanthus collar and is partially hidden behind the helices.¹⁹⁰

The Basilica and its Tribunal

The Basilica of Pompeii was built c. 120 BC. The basilica resembles the Vitruvian design from that at Fanum, where the basilica is made of two storeys. The lower storey is decorated with Ionic capitals, while the upper one, which is smaller in size, is decorated with Corinthian capitals.¹⁹¹ However, at the west end of the building is another two-storey building; a Tribunal. The latter is decorated with a low pediment, carried by six Corinthian capitals.¹⁹² Both the basilica and its tribunal were decorated with Corinthian capitals of the same design.

Gütschow provided the mathematical proportions of the capital, prior to Jones, but rather reflecting a parallel comparison with the Vitruvian ratios. It appears like the capital (Figure 115) is highly decorative and blooming. The double acanthus collar interlocks via the leaflets of each row; the lowermost leaf pairs of the upper collar overrides those of the lower collar, while they reverse positions with the leaflets above. The latter description of the acanthus leaves is somehow an improved or a more stylistic design of the soft acanthus leaves style, adapted from the Italo-Hellenistic Corinthian capitals.¹⁹³ However, the leaflets left from the upper collar hides behind the curved endings of the lower collar leaves. Usually, the curved ending of the acanthus leaves of any Corinthian capital is one leaflet. In this case, the curved leaflets are three. The leaflets themselves are not of the normal sharp or semi-round endings. The endings are wide, resembling fig leaves,



Figure 114. A reconstruction of an unearthened Corinthian capital from the Temple of Jupiter (Gütschow)



Figure 115. A reconstruction of an unearthened Corinthian capital from the Pompeian Basilica (Gütschow)

¹⁸⁷ Mau 1899: 66.

¹⁸⁸ Yegül and Favro 2019: 56, 57.

¹⁸⁹ Mau 1899: 63.

¹⁹⁰ Gütschow 1921: 69.

¹⁹¹ Böethius 1978: 149, 150–152.

¹⁹² Yegül and Favro 2019: 59.

¹⁹³ De Maria 1977: 177.

modified with lilac endings. The helices are rounding, convex, and emerge directly from the acanthus collar without any cauliculi or calyces. The volutes are wide, thick, concaved, and emerge from behind two acanthized leaves. Both the volutes and helices are coiling prominently. The volutes and helices are supported from below by pairs of water plants. The fleuron is placed partially on the kalathos and over-exceeding the area of the abacus. Its pedals are six in number – resembling the one from Tivoli. The capital is closer in design to the Alexandrian capitals, but with exaggerated, fleshy motifs.

The leaves occupy two thirds (2/3) of the total height of the capital, where the height of the lower row is 14cm, upper one is 14. The height of the volute area is 14, and the abacus is 7cm. The total height is 49cm.¹⁹⁴ Therefore, this capital is a perfect reflection of the Vitruvian proportions regarding the Corinthian capital design. Also, there is almost identical resemblance with the capital from the Temple of Vesta in Tivoli – see p. 66.

Sanctuary of Apollo

Regarding the Sanctuary of Apollo (Figure 116), it was built c. 120 BC, in the west of the forum. However, in regards of the dating of the temple itself, there is a confusion of either it was built in the 2nd or 1st centuries BC. Since the prior is a Hellenistic period, and the latter is after its Romanization, the design of the later Corinthian capitals might change accordingly.¹⁹⁵ Originally, it was executed using Doric and Ionic columnar order. However, it was reconstructed after an earthquake in AD 63 using Corinthian columns, probably on the second storey¹⁹⁶. It was highly influenced by the Hellenization of South Italy and reflected the Etrusco-Italian and Italo-Hellenistic elements.¹⁹⁷

The Corinthian capital (Figure 117) from the Sanctuary of Apollo is not Corinthian in its origin. It is most likely that during reconstructions, damaged or missing capitals are replaced, and regarding the Roman Republic, it was common in its late period to replace Ionic and Doric with Corinthian capitals as the new decorative capital. However, in the case of this Sanctuary, the original and already existing Ionic capitals were covered with stucco, transforming their shape from Ionic into Corinthian, using stucco.¹⁹⁸

Although the capital looks like, and is considered to be Corinthian, we can rethink it as using the existing Ionic volutes for the capital; thus transforming them into proto-Composite rather than Corinthian capitals – see proto-Composite capitals p. 70ff.

The decoration of the capital, based on the reconstruction,¹⁹⁹ has a singular acanthus collar of large leaves, covering about half of the kalathos. The single row collar was adapted from the Temple of Apollo at Bassai, but the large leaves resemble the design from Ai-Khanum (p. 27-9). The volutes – which are originally Ionic volutes – are supported by two acanthus leaves; one behind each volute. A wreath of three rows of leaves appears to be filling the area between the two volutes, replacing the helices, cauliculi, calyces and the abacus fleuron.



Figure 116. A fragment of a Corinthian capital from the Sanctuary of Apollo (Gütschow)



Figure 117. A reconstruction of the Corinthian capital from the Sanctuary of Apollo (Mau)

¹⁹⁴ Gütschow 1921: 74.

¹⁹⁵ Carroll and Godden 2000: 749–752.

¹⁹⁶ Mau 1899: 82, 83.

¹⁹⁷ Robertson 1929: 204; Böethius 1978: 231, note, 133. 9, 233, note 8; Winter 2005: 194, 196, 197.

¹⁹⁸ Mau 1899: 83; Carroll and Godden 2000: 746.

¹⁹⁹ Mau 1899: 84, Figure 31; Carroll and Godden 2000: 747, Figure 7.

House of the Faun, Pompeii

The House of the Faun is one of the most elegant houses in Pompeii, dated to the Tufa Period of the first half or middle 2nd century BC. The house was built and rebuilt through two phases; probably the first phase design was destroyed in an earthquake. The first phase was executed in Tuscan style. The second phase was by the end of the 2nd century BC, the Doric order from the Tuscan phase was replaced and Ionic and Corinthian orders.²⁰⁰ Corinthian capitals were found on both alae and the tetrastyle atrium between them.

The capital from the House of the Faun (Figure 118), known as “Fantastic Corinthian,” has much resemblance with the capital from the Basilica and few features adapted from the Temple of Apollo in Pompeii’s Forum. However, the motifs of the capitals and pilasters from this house – reflecting the general style of Corinthian capitals in Pompeii – are shallow.²⁰¹ The single acanthus collar is very fleshy. The leaves have large leaflet triple endings. The leaves are like those from the Basilica, but rather more prominent and highly detailed. The acanthus collar covers more than two-thirds of the space of the kalathos. The volutes are also like the Basilica capitals in size and design. The central helices are small, and are hidden behind an upper, folded acanthus leaf. In case of the House of the Faun, the helices emerge directly from the acanthus collar, rather than from cauliculi and helices – an Epidauran/Alexandrian feature. The fleuron is presented partly on the abacus’ lower lip and partly on the kalathos. The fleuron’s stem is completely hidden behind the acanthus collar and the central helices.

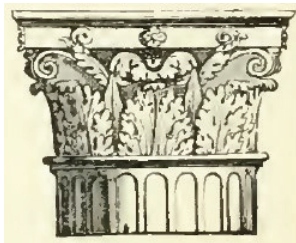

Figure 118. A reconstruction of the Corinthian capital from the House of Faun (Mau)

Jones provides the proportions of the capital as: total height of the capital = 0.435cm, height of the kalathos = 0.340cm, height of abacus, as a result = 0.095cm. The height of leaf range is 51% of the height of the capital = c. 0.173cm.²⁰²

Proto-Composite Capitals – Examples from Southern Italy

By mentioning the Fantastic capital from Pompeii, it is worth mentioning that similar capitals were discovered in Boscoreale, near Pompeii. The two examples (Figures 119, 120) mentioned by Ronczewski could be classified as proto-Composite capitals. Like the Fantastic capital, they have thin abacus and two corner volutes with a curved headband. The capital from Pompeii was interrupted by small helices, while two examples from Boscoreale are directly linked. A small motif appears above the volutes and underneath the abacus; a decorative helix-like element. The fleuron varies between a flower and an anthropomorphic head. It is essential to note that these types of Corinthian capitals, since they will evolve in the Julio-Claudian period, will become the canonical Roman Composite capitals.²⁰³



Figures 119-120. Two outline Proto-Corinthian capitals from the Boscoreale (Ronczewski)

This branch of Corinthian or proto-Composite capitals will need further studies

²⁰⁰ Dwyer 2001: 328–329; Donovan 2012: 28.

²⁰¹ Mau 1899: 289, 432, 434, Figure 242C.

²⁰² Jones 1991: 145.

²⁰³ Ronczewski 1923: 120.

and analysis by some researcher, hopefully, in the near future. I would like to hint that during my research, I had come across several capitals, from the Hadrian's Villa, which are close imitations and developments of such capitals.

Painted Corinthian Capitals from the Second Style Wall-Painting

The Architectural Style or the Second Style of the Pompeian Wall-Painting appeared between 90 BC and 50 BC in Pompeii and the surrounding region on the Bay of Naples.²⁰⁴ But, generally and originally, it appeared in the East after the death of Alexander the Great.²⁰⁵ First, it appeared on the walls of the Small Theater in Pompeii and remained to dominate wall paintings until the middle of Augustus' reign.²⁰⁶

This style shows the adaptation of the Alexandrian architectural art indirectly through the design of the Khazneh in Petra. Also, Pompeian Wall Painting is divided into two phases; the first was prior to 50 BC, while the second began in 50 BC. Phase II was more realistic in its representations than phase I. Only phase I will be discussed, since examples at hand with Corinthian capital wall-paintings are of this phase, which is also pre-imperial.²⁰⁷

This can be concluded by observing both the wall painting from the House of the Labyrinth, Oecus 43 in Pompeii (Figure 121) and the upper level of the Khazneh of Petra – see above, p. 53 I; all depict a tholos – clearly an adaptation of the tholos-shrine of Aphrodite on the Thalamegos– with a broken pediment – see p. 44-5. Although both the tholos and the broken pediment are Alexandrian in their depiction, the combination of both was presented in Petra, and thus copied into Pompeii's wall painting. Also, closer representations are shown in Villa of the Mysteries, cubiculum 16 (Figure 122) and Villa of P. Fannius Sinistor, Cubiculum M in Boscoreale (Figure 123) but for the prior with a different pediment type.

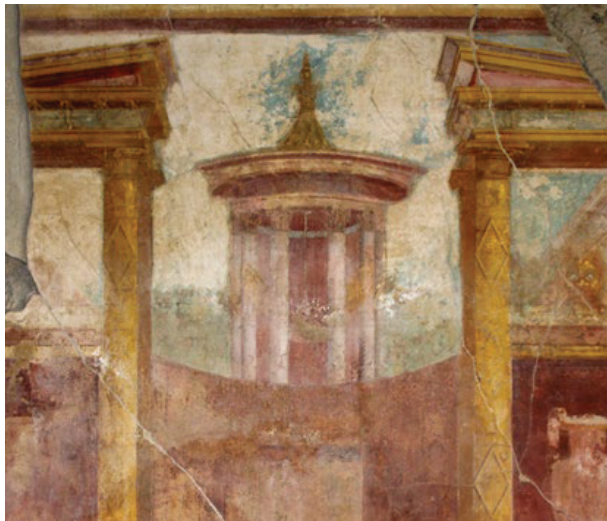

Figure 121. (left) *Oecus 43, House of the Labyrinth (McKenzie)*

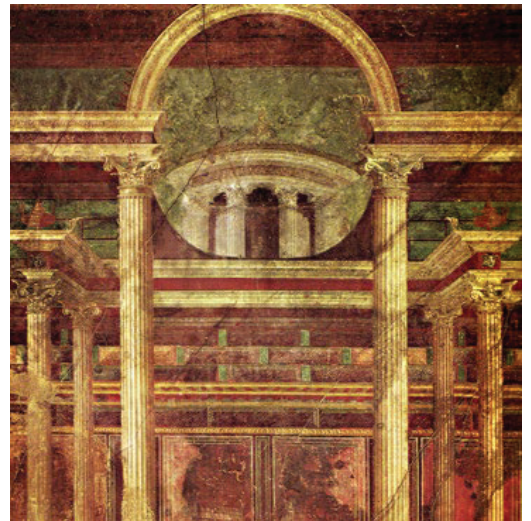

Figure 122. (right) *Cubiculum 16, Villa of the Mysteries (McKenzie)*

²⁰⁴ McKenzie 2007: 98; Mau suggested the date of appearance of the Second Style is 80 BC.

²⁰⁵ Mau 1899: 448.

²⁰⁶ Mau 1899: 452.

²⁰⁷ McKenzie 2007: 103.

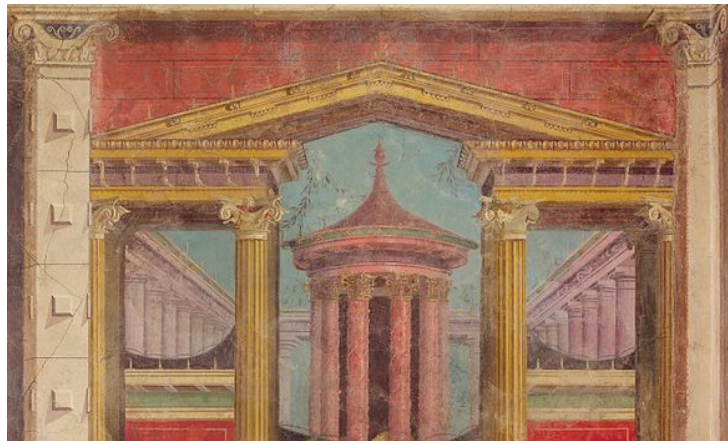

Figure 123. *Cubiculum M, Villa of P. Fannius Sinistor (McKenzie)*

Regarding the Corinthian capital representations on these architectural wall paintings, they seem to be a reflection of the Normal Corinthian capitals, which were common in Asia Minor and the Aegean Islands under Hellenistic influences. Researchers would deprive their origin from being Alexandrian. However, since we concluded above that the Normal Corinthian capital was a final step development from both the capitals of Samothrace and that of the Olympeion – which is evolved from the prior, we can indirectly attribute the capitals found on Pompeian wall paintings to be Alexandrian in their origin. However, there are also examples of Type I and Type IV Alexandrian Corinthian capitals, as well as close representations to Type II floral capitals from Petra, which themselves are an adaptation of the Type IV Alexandrian capitals.²⁰⁸ Examples of these capitals can be found in the following representations:

- Villa of the Mysteries, cubiculum 16 in Pompeii, displays two types of capital designs of phase I. The first is a Type-IV Alexandrian-like capital (Figure 124). It differs from the Alexandrian one by having its volute inner endings interlocking at the center of the kalathos' frontal side. The other capital (Figure 125) is a fusion of Type II and Type IV Alexandrian capitals, where the prior has interlocking helices. The upper part of the capital looks like the Type-IV-like capital previously mentioned. However, there is a double acanthus collar covering the lower half of the capital. Also, the central helices are supposedly back to back, but they are also interlocking.
- Villa of P. Fannius Sinistor, Cubiculum M in Boscoreale, has Type-IV-like Alexandrian capitals (Figure 126) holding the pediment surrounding the tholos representations – see Type IV Alexandrian and the Proto-Composite capitals, p. 41ff and 70ff.

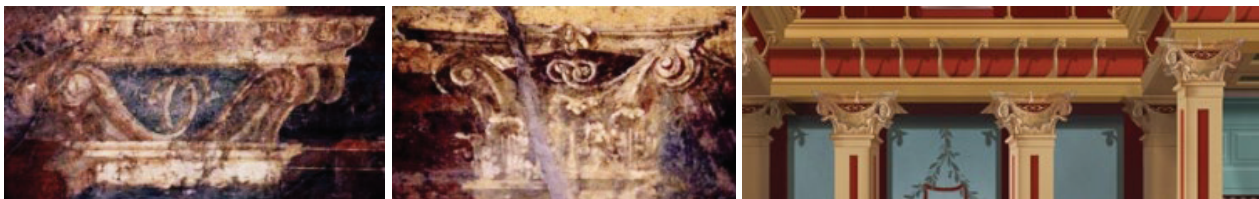

Figure 124-5. *(left and middle) Two Type IV Alexandrian Corinthian capitals, Pompeii (McKenzie)*

Figure 126. *(right) A set of Type-IV-like Proto-Composite capitals, Boscoreale (McKenzie)*

²⁰⁸ McKenzie 2007: 101, 103.

Triumphal Architecture, the Influence of Hellenistic Samothrace and the Hellenization of the Late Republican Period – Examples from Rome and the Latium Region

Regarding the 2nd century BC, it is interesting how most monuments in Rome was mainly erected in honor of the Roman generals who triumphed in and conquered the Eastern Mediterranean region under the Roman Republic. Following their conquests, there were always parades in Rome, displaying the spoils of war. However, a question is raised about the importance of parades, especially that from Samothrace.²⁰⁹ Also, this was the period where marble was introduced into the construction of temples.²¹⁰

Before discussing Corinthian examples from this section, it is important to bear in mind that the historical background of each temple plays a major and an important role. In this section, understanding the history of this period is as important as the analysis of each capital. Each temple was dedicated in a period of war and triumph, where *spoila*, divine dedications and the East Mediterranean territories of which each battle are related to the design of the temple; i.e. capital designs.

The importance of Samothrace was originally and deeply rooted in the Roman mentality; mythically, militarily, and artistically. Mythically speaking, it was the myth of Alexander the Great's greatness that emerged from the Sanctuary of the Gods at Samothrace. The island was also a reflection of the grandeur of the Hellenistic kings, who are Alexander's generals and their descendants. Therefore, the Hellenistic kings of the east displayed themselves as the bearers of Alexander's legacy. Also, the Roman gods were more connected with the gods from Samothrace in terms of cultic aspects. Military speaking, the expansion of Rome to the east was achieved by eradicating the Hellenistic existence in the Eastern Mediterranean region. Therefore, the Romans had replaced themselves as successors of Alexander the Great and conquerors of the Hellenistic kings; thus adapting and displaying Hellenistic spoils publically. The Romans also associated themselves with the cultures they conquered, as currently part of the Roman domain. Artistically speaking, Roman artists were attracted by Greek art and adapting their architectural motifs; therefore, it was normal seeking Greek sites for inspiration – and as a result of military conquests, accessing the site of the royal Sanctuary of the Gods. As a result, the Roman conquest of Samothrace might be the main or direct reason of the appearance of Corinthian structures in Rome.²¹¹

Porticoes

Porticus Octavia/Corinthia, Rome

The Corinthian colonnade of "Porticus Octavia or Porticus Corinthia"²¹² was erected by the naval commander Gnaeus Octavius after his triumph over Perseus,²¹³ and his capture at Samothrace, under Paullus. It was probably the first Corinthian stoa in Rome. It is dated to c. the second quarter of the 2nd century BC, but not before that date.²¹⁴ According to Pliny, it was a double portico, decorated with bronze Corinthian capitals; probably the first ever Corinthian building in Rome,²¹⁵ Unfortunately, a representation of the capitals' design is not available. The reconstruction done by Emperor Augustus will be discussed later – see p. 138.

However, there is a strong connection between the Porticus Corinthia and the architecture from Samothrace. The portico was originally constructed out of Consul Octavius' share of spoils of war.²¹⁶ Based on Pliny's

²⁰⁹ Popkin 2015a: 362, 364.

²¹⁰ Popkin 2015b:289; Yegül and Favro 2019: 28.

²¹¹ Popkin 2015a: 343–345, 357, 362–366.

²¹² It is different from the Porticus Octavia, which Emperor Augustus erected in honor of his sister in place of Porticus Metteli – see below.

²¹³ The last king of the Macedonian Antigonid dynasty.

²¹⁴ Winter 2005: 21.

²¹⁵ Richardson 1976: 60.

²¹⁶ Popkin 2015a: 357, note 94.

description of the portico being decorated with bronze capitals, one must think of them being only Corinthian, since only Corinthian capitals were associated with being of metalwork, either completely or partially, i.e. decorative motifs,²¹⁷ Since the bronze capitals spoils are from Samothrace, we must consider their similarity with the capital designs of both the Propylon of Ptolemy II and the Rotunda of Arsinoe II, p. 51-2; Figure 72.

Porticus Metelli, Rome

The portico is currently replaced with the Porticus Octavia from the Imperial period. The area within the Porticus Metelli held the two temples of Juno Regina and Jupiter Stator.²¹⁸ It was constructed by Praetor Q. Metellus after and in honor to his war and victory in Macedonia against king Andrscus, the pretending successor of king Perseus. The portico was constructed along the Temple of Jupiter Stator. It is probable that both the portico and the temple were built at the same time between his vow in 187 BC and his censorship in 179 BC, predating the construction of the Round Temple by the Tiber. The portico also circled the renovated temple of Juno Regina.²¹⁹ The portico, probably built by the same architect, was executed in a Hellenistic manner by Hermodorus of Salamis, probably of solid marble. The same quadriporticus plan was used in the Imperial period²²⁰. The original design of the monument was of four Corinthian pilasters; however, the original design is replaced with Severan capitals,²²¹ which will be discussed regarding the Augustan portico – see p. 82.

Temples

The Temple of the Lares Permarini (Temple D), Largo Argentia, Rome

The Temple of the Great Gods was erected in honor of Lucius Aemilius Regillus in 190 BC, after his victory over Antiochus III of Syria at Magnesia. Although the name Lares Permarini²²² refers to the the cult of Cabiri, it also referred to that of the great gods of Samothrace; a Roman equivalent. Mythically speaking, the reason being dedicating a Roman temple to Hellenistic minor gods of the sea is that L. Regillus had asked their help in defeating Antiochus III. This might be considered ironic, since Cabiri was a Hellenistic cult in protection of its kings, which Regillus had prayed to for help, and also visited the Samothracian Cabirium at the Sanctuary of the Gods to make a vow and give thanks.²²³

The temple was identified with Temple D²²⁴ in the "Area Sacra di Largo Argentina" in "Via delle Botteghe Oscure." This temple might be the earliest Corinthian temple built in Rome, executed in a Hellenistic manner. This temple might also predate the "Seleucid Olympieion in Athens" and might have had an influence over Antiochus IV himself since he "stayed at Rome after the Peace of Apamea in 188 B.C.E", which might have been the "architectural inspiration" for Cossutius and his design of the capitals of the Zeus Olympius – see Figure 11.

It is probable that during his visit to Samothrace, Regillus was influenced by its architecture, including the Ptolemaic propylon of Ptolemy II. Also, due to the relation between the Lares Permarini and the Carbirian cult, Regillus wanted to make a tribute by not only dedicating a temple to the Lares, but also imitate the

²¹⁷ Popkin 2015a:357. Also, we must consider the origin of the Corinthian capitals and how it was initially designed using bronze by Callimachus of Corinth.

²¹⁸ Stamper 2005: 53, 54.

²¹⁹ Popkin 2015b: 291, 292; Yegül and Favro 2019: 28, 30.

²²⁰ Popkin 2015b: 291–293.

²²¹ Lauter 1980-1: 38, 45; Gorrie 2007: 4, 7.

²²² Stamper 2005: p. 46.

²²³ Popkin 2015a: 346, 347, 351, 362, 364–366.

²²⁴ Stamper 2005: 81.

Hellenistic design of the Cabirium, thus the Sanctuary of the Great Gods. It seems that Regillus also wanted to highlight his triumph in Samothrace and not just his victory.

Therefore, we must keep in mind the Hellenistic Samothracian monuments of "Propylon of Ptolemy II, with its exterior freestanding Corinthian columns, and the Rotunda of Arsinoe II, with its interior engaged Corinthian Columns" – i.e. the designs of both capitals from the propylon and the Rotunda – see Figure 42, Samothrace and the Sanctuary of the gods for similar design.²²⁵

The Round Temple of Heracles Victor, Forum Boarium, Rome

The Round Temple in the Forum Boarium or the Round Temple by the Tiber, or the Temple of Heracles Victor²²⁶ is among the best preserved temples in Rome. It was dedicated to L. Mummius' triumph and Sack of Corinth in 146 BC.²²⁷ Same as Regillus, Mummius vowed to build a temple dedicated to Hercules. The temple is mainly an adaptation of Greek traditions of architecture.²²⁸ Since the Lysicrates Monument of Athens, round temples and monument did not have external usage of the Corinthian order. It was not until the 1st century BC in Rome that this tholos-temple used the Corinthian order for external decorations.²²⁹ The temple also has great resemblance with Greek architecture, especially the Athenian designs from the Zeus Olympius – see Figure 11. It reflects nothing from the Italian style, regardless the capital replacements from the imperial period.²³⁰ The design of the tholos-temple has resemblance of the Rotunda of Arsinoe II at Samothrace and the free-standing Corinthian capitals, probably adapted from those of the propylon of Ptolemy II from the same site of the Sanctuary of the Gods – see Figure 42.²³¹

Interestingly, the capitals are of two blocks. It shows two stages of evolution for the Corinthian capital, making it a linking between the original design of its capital and its replacement from the 1st century AD. For some reason, the southern and eastern sides of the temple show the original capitals, while the northern side of the tholos shows the replacements.²³²

Strong and Ward-Perkins presented theories by Altmann, Delbrueck, Weigand and M. Gütschow that debate the original dating of the two designs of capitals from the Round Temple.²³³ The early capitals were labeled "a" and the later ones as "b", based on the carving of the acanthus leaves.

Type "a" capitals (Figure 127) leaves are of the Italo-Hellenistic influence. The sinuses are wide, round and opened. The leaflet endings are sharp; both are Anatolian, Late Hellenistic features. There is a central, straight leaf between the acanthus collar and the volutes, which covers most of the fleuron's stem. The cauliculi and calyces have no similar representations in Roman architecture; the prior has narrow flutes. The small helices, along the flutes of the cauliculi, are



Figure 127. A late Hellenistic Capital "type a", Round Temple by the Tiber (Stamper)

²²⁵ Popkin 2015a: 343, 344, 346, 347, 349, 350, 351, 362, 364, 366.

²²⁶ Sear 1982: 30; however, the origin of the deity was still ambiguous by the time Sear wrote his book; Yegül and Favro 2019, p. 89.

²²⁷ Popkin 2015a: 351; Popkin 2015b: 295;

It was suggested to be built in 120 BC, also see Sear 1998: 20; or in 80 BC by Yegül and Favro 2019: 89.

²²⁸ Yegül and Favro 2019: 89, 90;

The temple is probably constructed by a Greek architect, since the marble used is Pentellic; also see: Sear 1982: 20. This is also probable why Sear in 1982 (the first edition) had linked its capitals with Greek and Anatolian capitals and how they resemble a closer design.

²²⁹ Stamper 2005: 69, 70.

²³⁰ Roberson 1929: 211.

²³¹ Popkin 2015a: 366.

²³² Stamper 2005: 71; Yegül and Favro 2019: 90.

²³³ Strong and Ward-Perkins 1960: 17, 18; Sear 1982: 20.

both Late Hellenistic features.²³⁴ The design of the fleuron takes about three quarters of the abacus' height, with part of the stem also on the abacus. Also, there is some resemblance with the Athenian temple of Zeus Olympius,²³⁵ since there no general familiarity with any of the imperial capital designs, regarding the Type "a" capitals.

Type "b" capitals (Figure 128) they have the lowest leaflet ending of an upper leaf overlapping the highest leaflet ending of a lower leaf; thus forming a narrow, small, closed sinus. However, this design was known for being post-Augustan.²³⁶ Also, the flat stem of the leaflet – which is not Hellenistic – the drilled sinuses of the leaves above the cauliculi, and the rough outlining of the leaves themselves is also post-Augustan. Similar helices and volutes are found on buildings from both the Augustan and Julio-Claudian periods – see, for example, Figures 200-201.²³⁷ However, the calyces are not acanthized; i.e., like that of the Zeus Olympius.

Therefore, we can conclude that Type "a" capitals are of the original design of the building, dated to the Late Republican period, and influenced by the Italo-infused Hellenistic architecture. As for Type "b" capitals, they have some features regarding the Augustan and the later Julio-Claudian and Flavian architecture; therefore imperial in their design.

The Temple-Tholos (Temple B), Largo Argentia

The Round Temple was erected and dedicated to Fortuna Huiusce Diei²³⁸ by Q. Catulus in 101 BC after his victory in the Battle of Vercellae in Cisalpine Gaul. Unfortunately, there are not enough evidence regarding the capitals of this temple-tholos. It seems that its capitals were of a two-block design Corinthian capital, that only the lower part (Figure 129) survived.²³⁹ They seem to adapt the S-shape of leaves from the Epidauran tholos and the triple leaflets from the Olympeion, as well as the small, round sinuses.

Rome's Capitulum and Post-Punic-War Corinthian Capitals – from Sulla to Caesar

The Sanctuary of Fortuna Primigenia, Praeneste/Palestrina

The Sanctuary of Fortuna is considered one of the finest examples that reflect Republican architecture. It was built c. 80 BC²⁴⁰ under Sulla. What concerns us about the Sanctuary is the upper level, which its terrace is decorated on the east hemicycle²⁴¹ with double Corinthian colonnades.²⁴²

The capital (Figure 130) from the terrace of the Sanctuary has great resemblance to that from the Temple of Vesta in Tivoli (Figure 107). The volutes are extremely large, but the one from the Sanctuary tend to coil on a large area, leaving a



Figure 128. An Augustan "type b", Round Temple by the Tiber (Stamper)



Figure 129. A lower drum from a Corinthian capital, Temple B, Largo Argentia (Stamper)

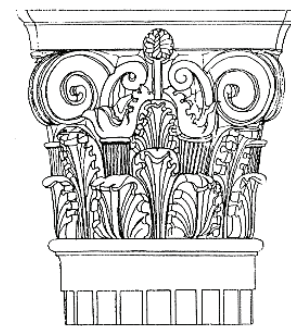

Figure 130. A reconstruction of a Corinthian capital, Sanctuary of Fortuna Pirimigenia (Fasolo-Gullini)

²³⁴ Strong and Ward-Perkins 1960: 22–24.

²³⁵ Roberson 1929: 211; Stamper 2005: 72.

²³⁶ Stamper 2005: 72.

²³⁷ Strong and Ward-Perkins 1960: 22.

²³⁸ Stamper 2005: 46, 75.

²³⁹ Popkin 2015b: 296.

²⁴⁰ Cruickshank 1996: 236.

²⁴¹ Yegül and Favro 2019: 103.

²⁴² Sear 1982: 26; also see the reconstruction of the terrace in Fiasco 2016: 88.

noticeable space of the interior of the volute, unlike in Tivoli. Also, the Sanctuary's capital has a pair of large and wide cauliculi and calyces, of which both the helices and volutes emerge, while in Tivoli, they emerge directly from the acanthus collar. The helices tend to stand independently, attached to the bottom of the abacus; while in Tivoli, the helices are covered on the top and supported from underneath by acanthi. The fleuron here seems to be of normal size, although partially resting on both the abacus and kalathos, with its stem visible; unlike the fleuron from Tivoli, which is extremely large with no visible stem. The acanthi double collar has S-shape design and opened sinuses.

It seems that the terrace capital still had traces of the Italo-Hellenistic architecture when it was carved by architects under Sulla. However, there are few adaptations from the Olympeion regarding motifs, but not an identical adaptation of them.

Temple of Castor and Pollux, Cori

This temple did not receive enough scholarly attention, and little is known about it. It was built after 80 BC. However, its capitals play an important role throughout the evolution of the Roman Corinthian capitals in Italy. It was described by Margarete Gütschow as follows: the ratio between the acanthus collar and the capital that the acanthus leaves reaches almost the middle of the capital.²⁴³

The capital from the Temple of the Dioscuri (Figure 131) has close resemblance to that of the Olympeion, but not identical. The double acanthus collar has leaves with extremely-bended endings, triple leaflet pairs, four leaflet endings, and three opened sinus pairs per leaf. The leaflet endings are smooth and semi rounded. The cauliculi are fluted, round, wide by the top rim and narrower by the acanthus leaves. The calyces are low, opened and acanthized. The helices are low, with a projecting lobe. The volutes are extending underneath the abacus, and its coiling endings are supported from below by the cauliculi. The volutes also have projecting lobes like the helices.²⁴⁴

The Temple of Venus Genetrix

Under Julius Caesar, the construction of a new forum began in 54 BC. The Forum Julium included a new temple dedicated to Venus Genetrix. So far, this could be the first temple in Corinthian style to include Carrara marble, from the Tuscan region, in its design, along the usage of tuff. The temple was also a clear example of Hellenistic adaptation in its general design. The usage of the Corinthian capitals was both internally and externally. In 1933, three of its columns from the reconstruction by Trajan were re-erected, which are still visible till today (Figure 132).²⁴⁵ From my point of view, this temple is one of the early steps towards the normalization of the Corinthian order in the forthcoming Roman Empire.

The Roman Capitolium and its Relation to the Antiochan Question

This section is the other side of the coin; the first was the Antiochan Question about the origin of the Zeus Olympius capital and how it was affected by Ptolemaic architecture indirectly. This other section is about how the Olympeion capital (Figure 11) had influenced and/or was copied into the Capitolium.

²⁴³ Gütschow 1921: 90.

²⁴⁴ Gütschow 1921: 69.

²⁴⁵ Stamper 2005: 93–95; Stamper 2014: 220, 221; Yegül and Favro 2020: 188, 335



Figure 131. A reconstruction of a Corinthian capital from the Temple of Castor and Pollux (Gütschow)



Figure 132. Corinthian capitals from the Temple of Venus Genetrix (Stamper)

The Capitulum, or the Temple of Jupiter Optimus Maximus Capitolinus, was originally built in the 6th century BC,²⁴⁶ c. 585 BC, and completed between 525 and 509 BC by the Etruscan kings²⁴⁷ using the Tuscan order – Phase I. It was the largest temple in the Republic, and was a triple temple for the triad deities of "Iuppiter Optimus Maximus, Iuno Regina and Minerva Augusta."²⁴⁸ It was reconstructed in 83 BC and dedicated in 69 BC – Phase II, using Tuscan and/or Hellenistic Corinthian capital designs,²⁴⁹ and tuff and lime stone or Pentelic marble – in later periods.²⁵⁰ The restoration carried in the time of Vespasian and Domitian will be discussed later regarding the imperial period – Phases III and IV.

The common conception about the reconstruction of the temple is that it was done before or after a revolt in Athens and sacking the city in 87–86 BC. The sacking included either columns from the temple of Zeus Olympius, or transporting one or more capitals to Rome to adapt the design for the Capetolium or simply adapting the design without removing any capitals from the original site. The real story will never be known, but the result is all the same, which I will be discussing and refuting below – see below, Theory I.²⁵¹

It is noteworthy that this section discussing the Capitulum was placed at the end of this part of the chapter is that no capitals remain of the Capitulum today. We can track several capital designs on several temples and compare it with that of the Capitulum, as well as historical descriptions and depictions. Therefore, one cannot determine an accurate design for the Capitulum capitals based only on the Olympeion ones or if Corinthian capitals were ever used in the first place, especially that there are various theories about how the Olympeion was not the original or direct source of influence or simply being rebuilt using the Tuscan order from the original Etruscan design. In case of the Olympeion capitals were used for the Capitulum, they had influenced the interior capitals, and later affected by Roman architecture, resulting in multiple minor, yet crucial changes in motif designs.

The first theory is already known to us, which is Sulla's adaptation of the Olympeion capitals and transferring them to be copied or used into the Capitulum, with the same design. However, what if this was not the case, regarding other researchers? This will lead us to a more complicated theory. Although being refuted, there is another interpretation, not mentioned by historians, which I shall interpret personally, by that time designs existing in Rome for the Corinthian capitals rather than just a mere adaptation of the Olympeion capitals.

The second theory is based on a reinterpretation and retranslation of the Latin texts by historians and architects regarding the Sullan sack of Athens and the moving of the capitals of the Olympeion, as well as deeper analysis of the period and the conditions of the Capitulum.

The Olympeion -based Corinthian Capital Adaptation – Theory I

The first theory is basically the oldest one. It has been common among scholars for about a century. Beginning with the most notable architects of the last century, Sir Fletcher, Dinsmoor and Robertson²⁵² had begun the practice of analyzing the literary source by Pliny the Elder's quote in the 36th book of *Natural History* that the adaptation of the Olympeion into the Capitulum was a literal one. However, it seems that their interpretation of Pliny's text was not as accurate as it was re-translated and used for the second theory, which I shall discuss below. This theory has no extended analysis, since the capitals of the Capitoline is directly related and almost identical to the capitals of the Olympeion in Athens.

²⁴⁶ Robertson 1929: 200.

²⁴⁷ Stamper 2014: 208.

²⁴⁸ Quinn and Wilson 2013: 124; Cruickshank 1996: 232; Yegül and Favro 2019: 82.

²⁴⁹ Stamper 2005: 82; Stamper 2014: 217, 218; Yegül and Favro 2019: 82.

²⁵⁰ Marquand 1898: 22;

The usage of marble, especially the Pentelic one did not come until the annexation of Greece, which opened a path for Roman traders and architects to bring such quantity of marble from Greece into Rome.

²⁵¹ Fraser 1921: 7; Cruickshank 1996: 232; Stamper 2005: 82, 225, note 88.

²⁵² Robertson 1929: 160; Dinsmoor 1950: 280.

Theoretically speaking, there are few evidences which support this theory. Gütschow mentions in the 1920s that both the temples of Castor and Pollux at Cori and that of Jupiter Pompeii, attributed to Sulla – see p. 68 and 77 – have Olympian influences regarding their capitals. However, Fagerlind mentions in the 1930s that the only direct influence of the Olympeion are the capitals from the terrace of the Sanctuary of Fortuna Primigenia; a poor theory, since the capitals of the Sanctuary of Fortuna (Figure 130) fall under the Italo-Hellenistic Corinthian capitals, but there are few similarities. Heilmeyer, writing after both Gütschow and Fagerlind say that the origin of the Normal Corinthian capitals is difficult to estimate.²⁵³ So, regarding these early theories, the closest examples they were able to validate and relate to the Olympeion is the Type "a" capital (Figure 127) from the Round Temple in Forum Boarium.

Strong, Ward-Perkins and Stamper²⁵⁴ paved the way to a theory previously discussed regarding the Round Temple. As mentioned above, the Round Temple was built in honor of Mummius after his victory in Corinth in 146 BC. Before him, Lucius Aemilius built a temple to the Great Gods in 190 BC after his victory in the East of the Mediterranean and coming across Samothrace. Both temples were built using Corinthian capitals from their spoils of war – see p. 73ff. Also, Antiochus IV built the Olympeion after his visit to Rome in 188 BC. So, we can consider both the Round Temple and Aemilius' temple of the Great Gods, as well as the original source of influence, Samothrace's Sanctuary of the Gods, are the main source of influence over Antiochus IV, so why not influence Sulla in regards of the Capitolium, which will naturally become a close reflection to Samothrace's Sanctuary of the Gods, especially that the temples at Cori and Pompeii are already influenced by local Corinthian prototypes, which could be very well based on the Round Temple and Temple D in Largo Argentia – see p. 74ff. Therefore, we can say, in case the second phase of the Capitoline was in Corinthian order, it was an indirect adaptation of Samothrace's capitals, hence Alexandrian in its origin.

Archeologically speaking, the only valid, yet weak proof about the usage of Corinthian capitals is numismatic. Several coins dated to the 1st century BC (Figures 133–135) show the Capitoline with two-rowed of large, blurred capitals. Also, a coin from the reign of Vespasian, dated to AD 68–9 (Figure 136) shows the Capitoline with Corinthian capitals. There is a probability about the usage of Corinthian capitals for the Capitoline, or it was the intention of the Emperor to use the Corinthian order for repairs after its destruction in the same year of minting the coin.²⁵⁵ I shall be discussing the third and fourth phases of the Capitulum in the next section about the Roman Empire.



Figure 133. (left) Denarius, 78 BC, Rome. RRC 385/1 (Siwicki)

Figure 134. (middle left) Denarius, 43 BC, Rome. RRC 487/2b (Siwicki)

Figure 135. (middle right) Denarius, 43 BC, Rome. RRC 487/1 (Siwicki)

Figure 136. (right) Denarius, AD 68–9, Gaul and Spain. RIC I second edition, Civil Wars 128a (Siwicki)

²⁵³ Abramson 1974: 11.

²⁵⁴ Abramson 1974: 12, 13; Stamper 2014: 217–219.

²⁵⁵ Siwicki 2020: 96, 97, 109.

The Sullan-Catulan Tuscan Capitoline – Theory II

This theory revolves around refuting the usage of the capitals from the Olympeion, either literally or symbolically for carving the Capitoline capitals. Here, we can discuss how the temple – in its second phase – was erected using the Tuscan order from the original design, as well as correcting the first theory about Corinthian capitals usage, but for interior columns.

First, we must consider Dionysius of Halicarnasus' description of the Temple of Jupiter Capitolinus' second phase as "τῆ πολυτελείᾳ τῆς ὄλης ὄνον ἰαλλάττωντοῦ ἀρχαίου," translated into English as "differed from the ancient structure in nothing but the opulence²⁵⁶ of its decoration."²⁵⁷ This means that the general design of the temple, including the exterior columnar order was identical to the original Tuscan order.

Second, Pliny says in his book, "*sic est inchoatum athenis templum iovis olympii, ex quo sulla capitolinis aedibus advexerat columnas;*" translated into the English version of the LOEB as "Thus they are a feature of the unfinished temple of Jupiter Olympius at Athens, from which Sulla brought columns to be used for temples on the Capitol."²⁵⁸ By analyzing the quotation, we can deduce that the "Capitol" does not refer to the Capitolium alone, but for "temples", thus the word "Capitol" refers to the Capitoline Hill as a whole, and the temples on the Capitoline Hill in context of the meaning. The columns, and not capitals, were the ones moved by Sulla, destined to various temples, and not only the Jupiter Capitolinus temple.

Third, the sack of Athens by Sulla was in 86 BC; however, the fire that destroyed the original Capitolium was in 83 BC; a result of a local revolt – Sulla's first civil war.²⁵⁹ Therefore, we can conclude that the fire was three years after Sulla's sack of Athens, not before. In other words, the moving of the columns was not intentionally for the rebuilding the Temple of Jupiter Capitolinus. There is a probability that the *spoila* from the sacking did serve its purpose in repairing several temples on the Capitoline Hill, based on the translation mentioned above, but not in repairing the Capitolium, which was already standing by that time.

Fourth, during the consulship of Catulus, he commissioned the construction of the Tabularium. This construction is dated between 80 and 70 BC. This building could be considered as a mirror image for the Capitolium under Catulus. The façade is constructed using stuccoed tuff and travertine limestone executed in the Doric order. The tuff and limestone, along with the Doric/Tuscan order, were common in the Late Republican period. Since the Tabularium and the Capitoline were both finished under Catulus, they could be reflecting one another.²⁶⁰

Finally, it is a wrong common conception to attribute the Capitoline to Sulla in the first place. Although the initiation for reconstructing the temple was under Sulla in 83–82 BC, Sulla did not live to see the construction completed. The temple was attributed to Sulla due to its relation to the Sack of Athens and the first theory, which was refuted above. Therefore, it was Catulus who finished and dedicated the temple in 69 BC. Siwicki says that "[i]n reference to the earlier, second rebuilding of the Capitolium, Cicero, Valerius Maximus, and Tacitus all refer to it as Catulus' *monumentum*, and he even took Capitolinus as a cognomen;"²⁶¹ nicknamed and originally attributed to Catulus rather than Sulla.

Water-Plant Capitals – Examples from the Eastern Provinces

The Water-Plant capitals are an Egyptian-based version of the Corinthian capitals, where they were decorated with acanthus collars, and the rest of the capitals are covered with water plants. These capitals could be found

²⁵⁶ Opulence (n.): Extreme luxury, in case of this study, in decorating.

²⁵⁷ Dionysius of Halicarnasus, *Roman Antiquities*, Book IV, chapter 61, line 4; Yegül and Favro 2019: 82; Siwicki 2020: 102.

²⁵⁸ Pliny, *Natural History*, Book XXXVI, chapter 5, lines 132–133.

²⁵⁹ Abramson 1974: 160 Siwicki 2020: 107, 108.

²⁶⁰ Siwicki 2020: 105.

²⁶¹ Siwicki 2020: 84, 177; cognomen (n.): surname, epithet or a name attributed to someone.

with or without acanthus collar, resulting in two subcategories found throughout the Roman Empire, and later, of course, in Egypt.²⁶²

The Tomb at Mylasa is the oldest monuments with water-plant Corinthianized capitals. Originally a Roman Republic construction, it was built in the 2nd century BC. It might be considered among the earliest Roman buildings of the provinces and one of the first Corinthianized capitals with water-plant leaflets (Figure 137). The tomb has strong resemblance to and reflects the influence of Hellenistic architecture,²⁶³ where the double acanthus collar has four leaflet sections, with a fleur-de-lis motif; an Anatolian feature. The tomb is in two levels, where the upper level is decorated with Corinthianized free-standing columns and four pilasters at the corners.²⁶⁴



Figure 137. A Palm capital from Mylasa (Wikipedia)

The Tower of Winds in Athens was built c. before the middle of the 1st century BC. The octagonal tower was a water clock designed by Adronikos of Kyrrhus. The capitals of the tower (Figure 138) were modeled after the capitals from the Tomb at Mylasa. The capitals were octagonal, decorated with a single row of acanthus collar. The rest of the capitals were decorated with tall and narrow water plants.²⁶⁵



Figure 138. A Palm capital from the Tower of Winds (Fletcher)

Augustan Architecture and the Rise of the Canonical Roman Orthodox Corinthian Capital

With the assassination of Caesar in 44 BC, Octavian joined forces with Mark Antony, forming the Second Triumvirate, and defeating the treacherous members of the senate. However, in c. 30 BC, Octavian defeated Mark Antony at the Battle of Actium, marking the end of the Hellenistic Period. He annexed Egypt into the Roman Republic. With the year 27 BC, he assumed the titles of Imperator, Pontifex Maximus and Augustus, marking the end of the Republic.²⁶⁶

Between 27 BC and his death in AD 14, Augustus constructed and renovated many of Rome's greatest monuments. Also, the usage of tuff and limestone was replaced by marble as a main element. The Corinthian order became the most used columnar order of his era and within the Roman Empire in general afterwards. This highlights one of the golden periods of the Roman Empire, which will be the focus of this section;²⁶⁷ highlighted by Augustus' famous quote, "I found Rome of clay; I leave it to you of marble."²⁶⁸

In this period, Rome did not receive foreign influences over its temples, but rather had an inner influential movement. Temples, those based on both Tuscan and Hellenistic-influenced architecture, had influenced one another, making each of the erected or reconstructed temples unique in its design and paved way for newer ideas and designs. The rapid drifting from Ionic to Corinthian order was a result of the various Eastern designs left behind by the Hellenistic Empire, especially with the introduction of Egypt as a new part to the Late Republic/Early Empire, resulting in attempts to achieve orthodoxy.²⁶⁹ It seems that the Late Republican period had introduced much and sufficient amount of art for the Roman artist. Also, in the time of Augustus,

²⁶² Ronczewski 1923: 134, 135.

²⁶³ Fedak 1990: 171.

²⁶⁴ Fyfe 1936: 55, 56; Dinsmoor 1950: 330.

²⁶⁵ Fletcher 1905: 88; Lawrence 1983: 180, 181

²⁶⁶ Ward-Perkins 1981: 21, 22.

²⁶⁷ Sear 1982: 62, 64; Yegül and Favro 2019: 191–193.

²⁶⁸ Dio, Cassius, *Roman History*, Book LVI, Chapter 30; Stamper 2005: 105; Stamper 2014: 221; Yegül and Favro 2019: 212.

²⁶⁹ Stamper 2014: 207, 216.

Vitruvius had come to write his masterpiece about architecture, which was basically based on the Eastern Hellenistic architecture.²⁷⁰

However, we must recognize how the adapted Corinthian capitals, until the time of Julius Caesar were very Hellenistic-influenced or Tuscan and locally based in their essence; unlike the capitals emerging in the time of Augustus, which had adapted and developed orthodoxy until Diocletian, as far as this section is concerned.²⁷¹

Augustus and the Rise of the Normal Corinthian Capital – Examples from Rome and Italy

Rome

Porticoes Corinthia and Metelli – Reconstructed

The Porticus Corinthia with the bronze Corinthian capitals, which we discussed above, was one of the monuments reconstructed by Augustus. The porticus was preserved with its same design, its name, and the name of Gn. Octavius as its "donor."²⁷²

Another discussed porticus is the Porticus Metelli. It was reconstructed by Claudius Marcellus in 33 BC, but paid for by Augustus and his spoils of war from Dalmatia. In 23 BC, the emperor had renamed the porticus to Porticus Octavia(e); a dedication after his sister's name.²⁷³ The rebuilding of this portico is attributed as Augustus' first major and public work, attributed directly to him, not counting the monuments left unfinished by Caesar. The portico was rebuilt by Augustus from its foundations, since the old portico was 133 years old by his time, and needed major repairs. Thus, it was easier to rebuild it from scratch.²⁷⁴

The reconstructed Porticus was presented through the Fourth Pompeian wall-painting style and by Desgondez²⁷⁵ in 1682, through Jones. The reconstructed design included only an exterior, double-colonnade of Corinthian capitals (*i.e.* Figure 138), while the inner columnar order was probably Ionic; unlike the fully-used bronze Corinthian capitals of the original monument.²⁷⁶

Temples of Victoria and Magna Mater-Cybele

Originally, the Temple of Victoria was erected by L. Magillus in 294 BC, while the Temple of Magna Mater was originally erected between 204 BC and 191 BC by M. Livius and C. Claudius. Both temples were rebuilt on their original site on the Palatine Hill. Probably, they were both rebuilt in 3 BC under Augustus, using the original Corinthian capitals, at least in case of the Temple of Magna Mater. Since the latter was highly assumed to be a resemblance of the capitals from the Capitolium of Pompeii – see Figure 114,²⁷⁷ it is probable that the Temple of Victoria would have been built using the same capitals.



Figure 138. A reconstruction of a Corinthian capital from Porticus Metelli (Jones)

²⁷⁰ Stamper 2005: 105–107.

²⁷¹ Stamper 2014: 218.

²⁷² Stamper 2005: 121.

²⁷³ Stamper 2005: 121; De Stefano 2015: 40, 44; Yegül and Favro 2019: 194.

²⁷⁴ Boyd 1953: 156; Richardson 1976: 61, 62.

²⁷⁵ Jones 1991: p. 101, Figure 5.

²⁷⁶ De Stefano 2015: 45

²⁷⁷ Stamper 2005: 118.

Temples of Apollo Palatinus and Apollo Sosianus

The Temple of Apollo Palatinus was erected between 38/36 BC and 28 BC on the Palatine Hill. It was decorated with six Corinthian columns.²⁷⁸ The current remains of the temple of Apollo are considered "as an imposing revival of Republican architectural traditions." Among the unearthed architectural fragments of the temple is an upper half of a semi-column's capital. The design of the temple is also very close to that of the Temple of Apollo Sosianus, making it a perfect example for comparisons and reconstructions.²⁷⁹

The capital's reconstruction (Figure 140) represents the standards of the Vitruvian Corinthian columnar capital. The capital's lower half is circled with a double acanthus collar of the Roman leaf design. Cauliculi and fully developed calyces emerge from the collar. The latter has both helices and volutes emerging from the same calyx. Also, two rosettes emerge from the calyces, each. The fleuron on the abacus is bud-shaped, with its thick stem emerging directly from the acanthus collar; partially, it is hidden behind the central helices.

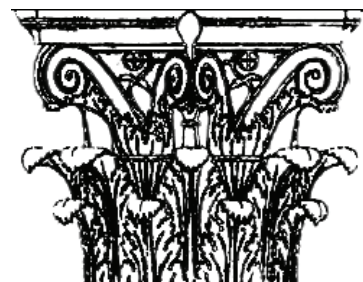

Figure 140. A reconstruction of a Corinthian capital from the Temple of Apollo Palatinus (Zink)

The Temple of Apollo Sosianus (Figure 141), originally Apollo Medicus, was erected in the area of Circus Flaminius between 433 BC and 431 BC, rebuilt in 179 BC and a second time between 34 BC and 20 BC. The latter reconstruction was done by general C. Sosius, one of Mark Antony's generals, for his triumph in Judaea. General Sosius erected the temple as an opposition to Augustus' temple of Apollo Palatinus. However, after the defeat of Antony and the arrest of Sosius, the general appealed to Augustus, thus gaining his favor. But, the temple's dedication was later intended to Augustus' victory in Illyria in 29 BC.²⁸⁰



Figure 141. Corinthian capitals from the Temple of Apollo Sosianus (Stamper)

The original temple was erected using the Corinthian columnar order; six frontal columns and ten columns and pilasters on its sides. The capitals were of two blocks. The volutes were supported by laurel leaves. Cauliculi and calyces emerged from the acanthus collar.²⁸¹

Generally, the exterior capitals of the temple of Apollo Sosianus are identical to those of Apollo Palatinus previously mentioned.²⁸² The capitals of the inner cella were decorated with a double collar of acanthus

²⁷⁸ Stamper 2005: 116, 117; Yegül and Favro 2019: 202.

²⁷⁹ Zink 2008: 47, 58.

²⁸⁰ Stamper 2005: 119; Coletta 2011: 179.

²⁸¹ Stamper 2005: 119; Sear 2021: 65.

²⁸² Zink 2008: 59.

leaves, covering the lower half of the capital. The upper half a "tripod surmounted with a woman's head inscribed in a corolla. This tripod was flanked by two serpents taking place of the acanthus volutes."²⁸³

Temple of Mars Ultor

The Temple of Mars the Avenger was a dedication by Augustus after his victory over Brutus and Cassius, in honor of avenging Julius Caesar's death. The temple was erected in Forum Julium, between c. 37 BC and 3 BC, but most of its foundations were laid in 10 BC. It was highlighted as "Augustus' most ambitious architectural undertaking." The usage of the Corinthian columnar order, influenced by Hellenistic architecture, had reached a new and orthodox design by the time the temple was finished. It is considered "the hallmark of the Roman Corinthian," for "[i]t was the definitive statement of the Corinthian order in the first century BCE."²⁸⁴

Therefore, the Temple of Mars Ultor could mark the beginning of the Corinthian orthodoxy throughout the empire in its early period (Figure 142).²⁸⁵ Generally, the temple has resemblance to Caesar's Temple of Venus Genetrix, regarding its façade of "eight tall Corinthian columns."²⁸⁶

Temple of Castor (and Pollux)

The Temple of Castor was built by Tiberius and was dedicated in AD 6. Only three free-standing columns remain of the temple today. Like the Temple of Mars Ultor, it became an example of Roman orthodoxy for the Corinthian columnar order, following the two temples of Apollo mentioned above.²⁸⁷

The capitals of the temple were carved of two blocks decorated with a double acanthus collar with five "overlapping lobes of leaves" forming "pear-shaped cavities," and were rich in details; two of them "overlap of adjacent points." The midrib is thick and visible, flanked with deep grooves (Figure 143). There is great resemblance to the acanthus leaves from the Temple of Mars Ultor. Helices and volutes emerge from the same cauliculi and calyx. The central helices are interlocking; an evidence of having Alexandrian and Hellenistic features – see Figure 33 above, and the Temple of Baalbek as contemporary Hellenistic evidence from the East, p. 109ff.²⁸⁸ While the helices are concaved and left blank, the helices are covered with a row of leaves; a rare feature found within the Augustan period only. Also, another Augustan feature is the small, third calyx emerging from the acanthus leaves, underneath the interlocking helices. From this calyx rises the stem of the abacus fleuron. This feature was found mainly within 40 BC and 20 BC. Also, the decorated abacus was presented by Augustus on the Temple of Castor, as well as the Apollo Sosianus. The decoration included the Ionic egg-and-dart motif; probably one of the early steps of fusing the two orders, which will lead to the creation of the Composite capital later on. The cauliculi are shallowly fluted, surmounted by fully developed calyces.²⁸⁹

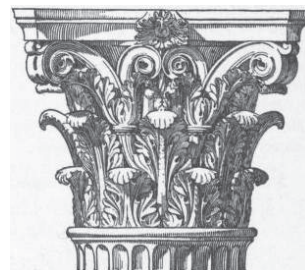

Figure 142. A reconstruction of a Corinthian capital from the Temple of Mars Ultor (Stamper)



Figure 143. A reconstruction of a Corinthian capital from the Temple of Castor (Stamper)

²⁸³ Stamper 2005: 120.

²⁸⁴ Yegül and Favro 2019: 204.

²⁸⁵ Stamper 2005: 130, 132, 141; Stamper 2014: 224

²⁸⁶ Sear 1982: 60; Yegül and Favro 2021: 203.

²⁸⁷ Strong and Ward-Perkins 1962: 12; Sear 1982: 60, 67; Yegül and Favro 2019: 197; see p. 85.

²⁸⁸ Strong and Ward-Perkins 1962: 12, 15, 223, 224; the two-block capital was common within the Augustan period; i.e. the Temples of Apollo Palatinus and Mars Ultor, and Arch of Augustus.

²⁸⁹ Strong and Ward-Perkins 1962: 14.

After discussing a wide variety of capitals from Rome under Augustus, we can highlight the main motifs of the Augustan Orthodox Capital and how they were common in design, which will influence, at least, the next two centuries of the Roman Empire. The following is originally presented by Sir Fletcher,²⁹⁰ Ward-Perkins,²⁹¹ Sear,²⁹² and Jones²⁹³ – mostly based on the capitals from the temples of Mars Ultor and Castor:

- Two-block capitals, with mono-block exceptions, mostly of Carrara marble.
- The lower block/half hosts the acanthus collar and the cauliculi.
- The upper block/half hosts the calyces, helices, volutes, the fleuron's stem with its cauliculi and the stemmed four-petalled rosettes, in case they were presented.
- The acanthus collar is rich, covering about half of the kalathos; a Vitruvian proportion.
- The acanthus leaves are round-ended, in form of the olive leaf.
- The acanthus lower top leaflet overlaps the upper low leaflet, forming enclosed, pear-shaped sinuses.
- The coiling of the central volutes reaches the lower edge of the abacus.
- The cauliculi are always fluted, with round, blank or Ionic-motif-like rings.
- A third and central, small cauliculus rises from the acanthus collar, of which the fleuron's stem emerges.
- The calyces are always fully developed, horizontally opened and supporting the corner volutes.
- Both helices and volutes – and the stemmed rosettes, in case presented, emerge directly from the same calyx.
- Both volutes and helices are concaved, with prominent non-lobed central coiling endings.
- The abacus, sometimes decorated, has a central fleuron of various shapes and designs.
- Serpentine or flame-like internal motif at the central fleuron on the abacus.

Sarsina, Italy

In the time of Augustus, the Corinthian capital design was close to being fully orthodox. However, there were other designs contemporary to the in-development orthodox capitals. The capitals from Sarsina, in North-East Italy, which we previously discussed as an extension to the Italo-Hellenistic capitals from Southern Italy, had took another turn in the time of Augustus. These capitals were influenced by the orthodox type presented in Rome, but also, at the same time, they kept the Italo-Hellenistic design.²⁹⁴

In Sarsina, the Monument of Obulaccus²⁹⁵ (Figure 144) and the Pian di Bezzo Necropolis²⁹⁶ (Figure 145) provides two capitals each, supporting the existence of both the Orthodox and Italo-Hellenistic designs, combined within the same capital. We can notice how the acanthus leaves are executed in a Hellenistic manner, while the volutes and helices were carved in a distorted manner,²⁹⁷ neglected as a main motif; a feature we shall encounter in Late Roman examples, especially in Alexandria.



Figure 144-5. Two Italo-Corinthian capitals from Sarsina (De Maria)

²⁹⁰ Fletcher 1905: 169, 171.

²⁹¹ Ward-Perkins 1967: 23.

²⁹² Sear 1982: 63.

²⁹³ Jones 1991: 113.

²⁹⁴ De Maria 1977: 198.

²⁹⁵ It is an architecturally-reduced funerary monument to commemorate one Aulus Murcius Obulaccus.

²⁹⁶ A Roman necropolis in Sarsina that hosts several monuments, including the one dedicated to Obulaccus.

²⁹⁷ De Maria 1977: 198, 199.

The two capitals from the Monument of Obulaccus have similarities with the capitals from both the Hellenistic Tomb at Belevi (Figure 14) and the Rotuna of Arsinoe at Samothrace (Figure 72) – consider that the latter is Alexandrian in its essence. The similarities with the Tomb of Belevi come in the design of the acanthus leaf and the ribs, while those with the Arsinoeion are in the design of the corner volutes coiling lobes. The Obulaccus capitals are also designed with grooved helices and cauliculi, and a wide fleurion; both features are Hellenistic and can be found at the capitals from the Rotunda of Arsinoe at Samothrace. Also, same description and features are found on the capitals from the Pian di Bezzo Necropolis. The only difference is that those of Obulaccus are of two blocks, while from the Necropolis are of single blocks.²⁹⁸

Pompeii

As previously discussed, the city of Pompeii is mainly famous for its mosaics and wall-paintings, even in regards of architectural elements, the Second Style of Pompeian wall-paintings are considered the main source. However, architectural elements became worth noticing by the Late Republican period – i.e. House of Faun (see Figure 118) and in the Augustan era. Even more, in Augustus' time, marble was used in residential architecture. Corinthian and so-called Corinthianized capitals were inserted into residential architecture, and not only presented through wall-paintings. These capitals, of which most were moved to museums in Pompeii and Naples, are ambiguous regarding their original site. After the AD 62 earthquake, what was left was moved into some villa rooms to be stored. In case of Villa A Oplontis, the removed and dismantled capitals were found in "two environments: the first was the whole capitals collected in one place for recycling, while the other is by following the U-shaped clip found at the blocks of the capital for attaching them together."²⁹⁹

Villa A Oplontis, Boscoreale

By observing the Corinthianized capitals from the villa, we can come to a general feature that all capitals share the same two features. The upper half of the capital is Alexandrian in its essence, reflecting Type I, III and IV of the Alexandrian Corinthian capitals, while the lower half of the capital is surrounded by a single, alternating acanthus collar;³⁰⁰ an Anatolia feature. The categorization of the capitals divides them into the following groups. Two groups will be discussed in this section, while the other two will be categorized along the Floral capitals – see p. 94ff.

- Group I consists of two capitals (Figure 146), where the upper half of the capital is decorated with a double S-shaped, acanthized volutes and a central palmette. The acanthus collar is of the standard Roman acanthus leaves, with enclosed, almond-shaped, non-overlapping sinuses. The abacus is decorated with a central six-petal fleurion. Similar capitals will appear in the Late Roman period.
- Group II consists of five capitals (Figure 147), where the acanthus collar is identical to that of Group I, although it could appear as a double collar, but the leaves are alternating in a zig-zag manner. This is why some leaves might appear higher than the other, giving the double-collar feeling. However, the



Figure 146-7. Two Corinthian capitals from Boscoreale (Pensabene)

²⁹⁸ De Maria 1977: 198–201.

²⁹⁹ Pensabene 2018: 45–47;

"Anche quasi tutti I capitelli sono stati trovati già raccolti in due ambienti principali: dovevano rappresentare una scelta di quelli ritutilizzabili tra quelli crollati durante il terremoto e di molti di essi era stato effettuato, o era in corso d'opera, il restauro tramite grappe ad U per ricongiungerli con le parti staccatesi (v. particolare gli spigoli degli abaci)."

³⁰⁰ Pensabene 2018: 51.

upper half is decorated with acanthized volutes and helices. The central motif takes the shape of a triple spear-head-like calyx. The highest speared leaf extends towards the abacus, forming the fleuron's stem. The abacus is decorated with a central fleuron, but of four petals rather than six.³⁰¹

Temple of Venus, Pompeii

The temple of Venus was originally built under Sulla after the colonization of Pompeii. It is highly probably that it was built in the same time as the previously mentioned Temple of Jupiter, in the center of the Area Sacra. A second renovation is suggested to have taken place in the middle Augustan period or the early years of the Julio-Claudian period, while a third restoration phase took place after the AD 62 earthquake. The temple probably had a prostyle of six frontal columns. The temple, in its second phase, was decorated with two designs of the Corinthian capital by its east and west double colonnades, probably the expansion phase of the temple.

Corinthian capitals from the temple vary in both height and type. Regarding size, it appears that the smaller capitals were used either within the temple cella or the upper order of the portico; an explanation for why two capitals appear to be cut, since they rested on the inner cella walls. Based on the analysis by Mau, Pensabene concluded that the two types are of two following eras, where Type I was used between 20 BC and AD 10, while Type II was used between AD 10 and AD 30.³⁰²

Figure 148: A Type I capital, where the lower half is decorated with a pair of fluted cauliculi and a standard roman acanthus collar, with enclosed, oval-shaped sinuses and semi-round leaflet tips. The upper half hosts the calyces, helices and volutes. The helices are linked with a ribbon, passing over the stem of the fleuron. The coiling endings of both the volutes and helices end in a round disk, rather than the standard design.³⁰³

Figure 149: A Type II capital that shows a more simplified but rather elegance of the design than the previous type. The acanthus leaves have triple leaflet endings, and only the midrib is presented, shallower and more round than that from Type I. The sinuses are enclosed and almond-shaped. Central helices are connected with a ribbon, like Type I. The volutes and helices are simplified, smaller in size than those of Type I. The fleuron's stem emerges from a central calyx.³⁰⁴



Figure 148-9. Two Corinthian capitals from Pompeii (Pensabene)

Augustan Corinthian Capital in the Western Provinces

The dominance and influence of Augustus throughout the first half of the 1st century AD, as well as his architectural revolutionary design of the Roman Orthodox Corinthian capital, was not only within the boundaries of Rome. Although a more variety of Examples are found in the following years of his successors, the Western Provinces of the Empire witnessed this transformation at its early years under Augustus. The reason of dividing the provinces, especially that they were not officially divided like they were under Diocletian, is to facilitate the comparison among the evolution of the Corinthian capital in Roman territories.

³⁰¹ See for more examples from both groups, see Pensabene 2018: 51, 52.

³⁰² Jacobelli and Pensabene 1995-96: 45-48, 53.

³⁰³ Jacobelli and Pensabene 1995-96: 53, 54; see same reference p. 55 for a pilaster of the same capital design. Also, the pilaster design has the V-shaped calyces in a narrow form than that of the capital.

³⁰⁴ Jacobelli and Pensabene 1995-96: 56, 57.

As for the Western Provinces, we can conclude that their architecture was somehow primitive, unlike Greece or Egypt; an explanation of how the architecture of Gallica, Hispania and Britannia was a mirror reflection of that of Italy and Rome.³⁰⁵ Since almost nothing was left from Roman Britain, as a result of the Anglo-Saxon dominance over the British Isle and the eradication of pagan symbols and monuments, I shall be focusing on Gaul, parts of Germania and Hispania.

Throughout this section, we can trace the evolution of the Corinthian capital throughout southern and eastern-southern Europe throughout three phases. In Gaul and nearby Germanic territories, we can find influences of the Orthodox Corinthian capitals. In Southern Gaul and Hispania, we can find influences related to the Italo-Hellenistic architecture of Southern Italy. However, in Hispania alone, we find capitals influenced by the Floral capital designs, almost identical to those from Pompeii.³⁰⁶

Temples

Maison Carrée, France

The square temple in Nîmes was dedicated to Rome and Augustus, known as the Square House, was erected in c. 19 BC, France. The temple was decorated with a hexastyle porch, decorated with Roman Orthodox Corinthian capitals (Figure 150). What makes this temple unique is its perfect condition, which reflects, in our case here, the clearest design of orthodox capitals from the Roman Western Provinces. We can see how its capitals are highly influenced by the Roman Temple of Mars Ultor.³⁰⁷ For capital description and analysis, see Figure 142.



Figure 150. A Corinthian capital from Maison Carrée (maisoncarree.eu)*

Temple of Diana, France

The so-called Temple of Diana in Nîmes, probably a nymphaeum, was built in early 1st century AD, most probably under Tiberius, using the Augustan influence. Its façade was rebuilt in the 2nd century AD under Hadrian. The temple was decorated with two types of capitals.³⁰⁸



Figure 151. A reconstruction of a Corinthian capital from Temple of Diana, France (Fletcher)

The Floral capitals of the temple (Figure 151) have a single collar of tall acanthus leaves, floral-wrapped volutes and a set of eighteen small petals, divided into four rows. Two main petals set at the bottom between the acanthi, of which two petals emerge from each one of them. Each of the second row petals has one petal emerging from it and then two more emerging from the third row petals. The petal sets had replaced the omitted helices, cauliculi and helices.³⁰⁹

Temple of Diana, Portugal

The so-called Temple of Diana in Évora, Portugal, erected in the middle of the 1st century AD, is another temple affected by the Augustan classicism and Orthodox Corinthian capital design, although it was erected by and/or in the time of Vespasian. The temple was a hexastyle, peripteral construction. It was

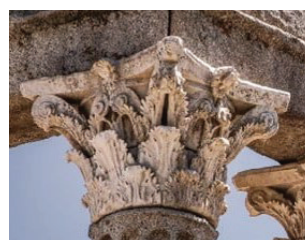

Figure 152. A Corinthian capital from Temple of Diana, Portugal (Wikipedia)

³⁰⁵ Yegül and Favro 2019: 442.

³⁰⁶ Anderson Jr. 2013: 62, 63.

³⁰⁷ Yegül and Favro 2019: 442, 443; Sear 2021: 22, 218.

³⁰⁸ Fletcher 1905: 125; Cruickshank 1996: 254.

³⁰⁹ This capital design has close similarities to the Type IV Alexandrian Corinthian capital but, it is elongated, and without helices in some cases.

decorated with marble Corinthian capitals (Figure 152) of the same design of those found at Maison Carrée (Figure 150) and the Temple of Mars Ultor (Figure 142).³¹⁰

Temple of Sulis Minerva, England

The Temple of Sulis Minerva in the Roman town of Aquae Sulis, currently the city of Bath in the county of Somerset, was one of the very few surviving temple in Britannia. The reason behind its survival is being dedicated to a local Celtic healing god Sulis, rather than a Roman god. The capitals of this temple (Figure 153) are very close to those from Maison Carrée (Figure 150), but at a closer look, we can sense the interruption of the Celtic style, affecting the design of the temple mainly, and the capitals on a lesser scale, existing nonetheless.³¹¹



Figure 153. A reconstruction of a Corinthian capital from Temple Sulis Minerva (Meguid)

Templo Romano, Spain

The so-called Temple of Claudius Marcellus in Cordoba belongs to the 1st century AD, probably from the last quarter of the same century, built by the same man whose name is attributed to the temple; a nephew of Emperor Augustus and the founder of the city itself. The capital design on display at the archeological museum of Cordoba (Figure 154) shows how the design is identical to the canonical orthodox design of the Corinthian capital. The proportions follow the Vitruvian measurements, except for the acanthus leaves, where each acanthus leaf is divided into two sets of leaflets. The lower leaflet pair has five semi-pointed endings, while the upper leaflet pair has three endings. The carving of both the volutes and helices is flat, and they are linked with a ribbon; a Hellenistic, Floral capital motif – see p. 109ff for comparisons.³¹²



Figure 154. A Corinthian capital from Templo Romano (Bemeherid)

*Augustan Honorific Monuments from Italy and the Western Provinces*³¹³

Although most of the imperial monumental arches erected by Roman emperors were decorated with Composite capitals, it appears that early imperial arcs, especially those by Augustus, were decorated with the canonical Corinthian capitals.

Italy

- The early Augustan Arch at Rimini (Figure 155) was erected by the Senate in honor of Augustus in c. 27 BC. It was erected as a city gate, like that at Pula – see Figure 158. The arch is decorated with a pair of Corinthian columns.

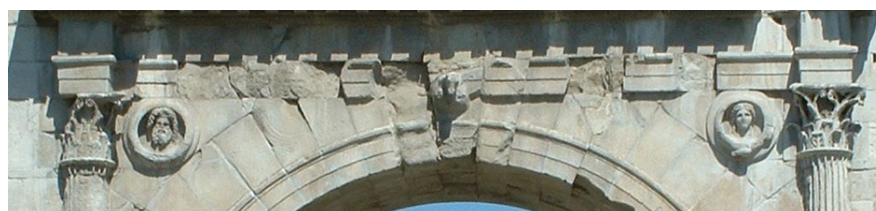

Figure 155. Corinthian capitals from the Arch at Rimini (Wikipedia)

³¹⁰ Yegül and Favro 2019: 423, 424; Sear 2021: 212, 213.

³¹¹ Yegül and Favro 2019: 429; Sear 2021: 224.

* <https://www.maisoncarree.eu/en/monument-2/architecture/carved-decoration/capital/#chapiteau-3>

³¹² Behemerid 1983a: 32.

³¹³ Anderson Jr. 2013: 75, 77; Yegül and Favro 2019: 431, 435, 438, 440; Sear 2021: 261.

- Augustan Arch at Aosta, Turin (Figure 156) is an arch dedicated to the "founding of the Cisalpine colony" in 25 BC. It was executed in the same manner of the arch at Rimini (Figure 155). The arch is decorated with a pair of Corinthian columns.



Figure 156. Corinthian capitals from the Arch at Aosta (Wikipedia)

- Arch at Susa, Turin (Figure 157) was erected in 9 or 8 BC, in honor of a peace treaty between Augustus and M. Cottius, king of the Alpine tribes. The monument was decorated with three-quarter Corinthian columns. The design of its capitals is comparable with the Arch at Sergii, Pula – see Figure 158.



Figure 157. Corinthian capitals from the Arch at Susa (Wikipedia)

Western Provinces

- The Arch at Sergii in Pula, Croatia (Figure 158), built in c. 27 BC, is a city gate and a funerary monument, decorated with a pair of double Corinthian columns.



Figure 158. Corinthian capitals from the Arch at Sergii (Wikipedia)

- The Arch at Barà, Spain (Figure 159) was erected in c. 13 BC. The arch is decorated with "sharply outlined Corinthian" pilasters.



Figure 159. Corinthian capitals from the Arch at Sergii (flickr.com)*

- Les Antiques de Saint-Rémy-de-Provence (Glanum), France; the Arch at Glanum and the Monument of the Julii. Both monuments were erected between AD 10 and AD 20. The Monument is a tower-like structure, decorated with four three-quarter Corinthian capitals (Figure 160). The arch is decorated with double Corinthian capitals, like those from the Arch at Aosta – see above.



Figure 160. Corinthian capitals from the Arch at Sergii (flickr.com)*

Augustan and Contemporary Hellenistic Corinthian Capitals in the Eastern Provinces (Excluding Egypt)

Unlike Western Europe, which was ruled by chieftains and local tribes before the arrival of the Romans, the later-to-be Eastern part of the Roman Empire was more complicated. The existence of the Greeks and their rich culture, which apparently was a main reason for the rise of the Roman Empire culturally, made the East more complicated. By the time Augustus came to power, the Hellenistic Kingdoms were in decline. However, their direct or indirect influence still existed and in a strong manner that it matched the Roman one.

Greece and Asia Minor, as well as Syria, were already annexed during the Republican Period, as previously discussed. Egypt was the last territory and dominant force to be conquered, with its Hellenistic political influence, had fallen to the Romans by the time of Augustus. Therefore, monuments discussed from Egypt, the Levant, Asia Minor and Greece will have been already under the shadow of the empire, and their existence was a continuation of the practices inherited from the Hellenistic times; Hellenistic styles existing and parallel along the Roman designs, in our case, of the Corinthian capitals. Therefore, we can predict the existence of

* <https://www.flickr.com/photos/7455207@N05/3712805295>

* <https://www.romeartlover.it/Glanum.html>

various designs based on the Hellenistic models, as well as those later based on the Roman Orthodox capitals, which apparently will not be as canonical as the ones from Rome and the Western Provinces.

Greece – The Odeion of Agrippa, Athens

With the Roman annexation of Greece, the newly rebuilt city of Corinth became the capital of the Province of Achaëa, while Athens was left unattended. However, there was little contribution in the early years of the empire, since the Academy of Athens was still functioning, forming a center of attraction for students. The Roman influence at the time of Augustus and during the first century was more like a continuation of the already-existing tradition of building, where the Corinthian order was not decorating every temple, street and house, like in Rome; highly dominated by the Athenian Classical architectural spirit. Therefore, the Augustan and early examples regarding the Corinthian capitals will be only handful.



Figure 161. A Corinthian capital belonging to the Odeion of Agrippa (Wikipedia)

The Odeion of Agrippa is the most worth-mentioning Corinthian monument from this period, since it will assume the role of the eastern version of the canonical Augustan capital. It was built in c. 15 BC, and decorated with "pilasters of Corinthian order, eight along the north façade and ten along the east and west sides." Also, its internal colonnade was decorated with "lotus-and-acanthus form;" a design of Corinthian capitals (Figure 161) found later at the Tower of Winds, which I shall be discussing later in this chapter – see Figure 138.³¹⁶ The capital design of the exterior order of the Odeion was unmistakably Roman in its essence, following the canonical design from Rome.

Asia Minor – Temple of Rome and Augustus, Ancyra/Ankara

Like in Greece, Asia Minor had its own architectural approach, which was not easy for Rome to affect or change. If Athens' architectural influence was merely Classical, then Asia Minor, and in case of our example, the city of Ancyra, was of Hellenistic architectural approach. In the following years, starting from the 2nd century AD, we can see how, for example, Pergamum and also Ephesus under Hadrian were very influenced by Roman architecture – see p. 111ff.

The Temple of Rome and Augustus in Ancyra (Figure 162) was a Roman temple with a Hellenistic approach, that researchers, in the beginning, thought that it was a 2nd century BC temple. It was a grand, octastyle temple, decorated with Corinthian capitals. Generally, the temple was a fusion of the canonical Mars Ultor design from Rome and the Hellenistic styles from the east.



Figure 162. A reconstruction of the Temple of Rome and Augustus (Taxier)

³¹⁶ Ward-Perkins 1981: 255, 256, 263, 267, 273.

East Mediterranean Coast – Baalbek and Palmyra

The case of Baalbek and Palmyra is like that of Asia Minor; a direct Hellenistic influence. However, Baalbek, as we shall see below, has not only under Seleucid influence, but also Ptolemaic.³¹⁷ The presence of these two Hellenistic kingdoms, as well as being a region that exchanged hands between them during the earlier centuries, and also from the Roman presence, we can conclude how the influence was both Hellenistic and Roman together, unlike Asia Minor, which was a middle ground for both Hellenistic and Athenian Classical architecture. Moreover, the Corinthian order was dominant in the Syrian territories; an achievement that began with Antiochus IV. Therefore, there is a great variety of Corinthian styles and fusions to be discussed in this section.

The Temple of Jupiter-Baal, Baalbek

The Temple of Jupiter-Baal (Figure 163) is part of a great sanctuary dedicated to both local and Roman deities – Sanctuary of Jupiter Heliopolitanus, where syncretism played part in Roman policy in subduing the locals. The completion of the sanctuary with its main three temples extended until the 3rd century AD. Only the Temple of Jupiter was completed in the 1st century AD, which I shall discuss here. The establishment of the temple began with the Roman footing and colonization of the area in 16 BC.³¹⁸

The main temple was dedicated to Roman Jupiter and the local god of storms Bel – an equivalent to the Roman god Helios. The temple was built over the site of a 6th century BC sanctuary, but was rebuilt and finished by the Romans between AD 60 and AD 70. The temple was a fusion of both Roman and Hellenistic architectural mastery. The temple was pseudodipteral. Six columns of the southern colonnade were re-erected. The design of its capitals was Augustan-based;³¹⁹ the earlier design of capitals had interlocking central helices; a feature adapted from the Temple of Castor in Rome (Figure 143), originally inspired by Alexandria – i.e. Figure 33, while its later capitals were a reflection to the capitals from the temple of Mars Ultor (Figure 142).³²⁰



Figure 163. A set of Corinthian columns from the Temple of Jupiter-Baal (Wikipedia)

Temple of Bel, Palmyra

The temple was dedicated to the chief god Marduk from the Mesopotamian mythology. The temple was built in AD 32, but its expansion project, regarding the propylon and the temenos, extended towards the 2nd

³¹⁷ Ward-Perkins 1981: 273, 279, 314.

³¹⁸ Yegül and Favro 2019: 732, 737.

³¹⁹ Schlumberger 1933: 292; Sear 2021: 250.

³²⁰ Fyfe 1936: 42; Ward-Perkins 1981: 314, 316, 317; Nasser 2013: 169, 170; Yegül and Favro, 2019: 737, 738, 742; Sear 2021: 249, 250.

century AD. The propylon of the temple was decorated with eight Corinthian columns (Figure 164), as well as "[a]ll four sides of the interior enclosure." Also, the temple itself, an octastyle, pseudodipteral ground-planned, was decorated with Hellenistic free Corinthian capitals tending towards the canonical Augustan model; i.e. the capital from the inner cella's façade (Figure 164B).³²¹



Figure 164A. *Two Corinthian columns from the Temple Bel (Pinterest.com)*



Figure 164B. *A Corinthian pilaster from the Temple of Bel (Schlumberger)*

Roman Floral Corinthian "Corinthianized" Capitals in the Augustan Era

After discussing the variety of Corinthian capitals from Pompeii, we should mention the rest of the Corinthianized capital groups unearthed, discussed by Pensabene, as well as similar examples from the Western Provinces, and how they were related. Behemerid identifies them as vegetal-volute capitals; however, I shall be discussing certain examples, where the central helices coiling endings are replaced with rosettes.

These types of capitals were originally and generally identified by Ronczewski, and carefully analyzed by Behemerid, in regards of the examples from the Iberian Peninsula. Behemerid, based on Ronczewski, describes the capitals are being a product of the Late Republican period, but were common in the Augustan period. The kalathos is usually round or rectangular, decorated with a single row of acanthus, in most cases. The collar around the kalathos is usually of alternating acanthi and palmette leaves or acanthi and water plants. The acanthus leaf design is adapted from the Roman version of acanthi from the canonical Augustan capitals.

These types of capitals were used for decorating small buildings, private residences or interior decorations, as in Pompeii, where they were originated. Usually, they were presented on pilasters and/or flat-surfaced capitals. The various designs of these capitals are centered on the helices orientation and the types of leaves used for the collar. Also, these types of capitals had a direct Hellenistic influence; the floral motif from the Nabataean capitals of El-Khazneh at Petra³²² – see the Nabataean Floral capitals in Chapter I (Figures 74 and 79) and their relation to the Alexandrian Corinthian types, especially the floral motifs from Type IV (Figure 58).

By combining both works of Ronczewski and Behemerid, we can divide these floral-decorated helix capitals into two main categories: Group I and Group II, where Group I is based on the Alexandrian schematics of helix designs, simply with a pair of helices on each side of the capital, while Group II is divided into two sub-categories, based on the orientation of the double central helices, resulting into not one but two pairs presented on each side of the capital. A third group; however floral, imposes the floral design of volutes and helices over the canonical Augustan capitals, where only one example is currently available at hand.

³²¹ Schlumberger 1933: 294; Ward-Perkins 1981: 354; Yegül and Favro 2019: 776, 778.

³²² Behemerid 1983b: 73–75.

Group I

The first type is the single pair of floral-decorated helices. This type is based on the Classical Epidauran capital, infused with the Alexandrian Corinthian capital helices orientation, but the central helices ending are floral in design, unlike the normal coiling; a Hellenistic feature found at Petra.

Type I Alexandrian-based, Floral capitals³²³

- The capital from Villa Medici at Rome (Figure 165).
- A capital from the National Roman Museum (Figure 166), with floral-decorated helices.
- The Museum of Naples, with floral decorated volutes (Figure 167).



Figures 165-167. Alexandrian Type I Floral capitals from Italy (Ronczweski)

Type III (lyriform) Alexandrian-based, Floral capitals

- A capital from the Museum of Aquileia (Figure 168), where both the helices and volutes are replaced with floral endings.
- A reused capital at the Basilica of St. Clemente, Rome (Figure 169).
- Two capitals from the Roman Antiquarium (Figures 170, 171).

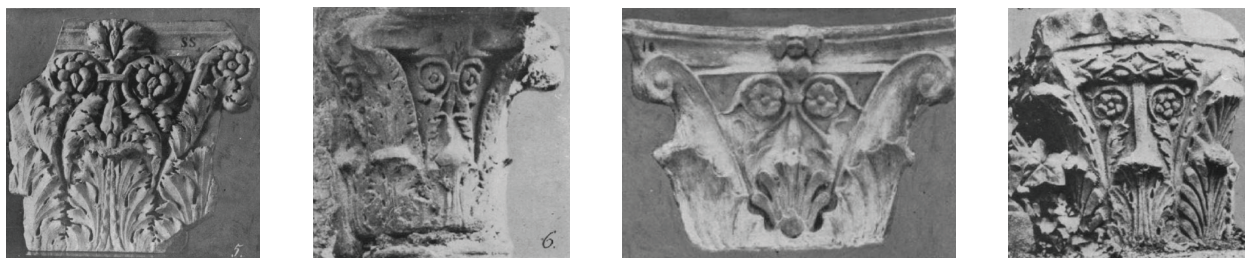

Figures 168-171. Alexandrian Type III Floral capitals from Italy & Spain (Ronczweski)

- The Villa Oplontis Group III from Pompeii consists of ten capitals, where only two examples are sufficient. The acanthus collar is a single row of both alternating acanthus leaves at the center of each side and palmette leaves at the corners (Figure 172) or fully of palmette leaves (Figure 173). In either case, palmette leaves are decorated with two pairs of side acanthi leaflets, and also a triangular motif. The volutes are acanthized, while central helices emerge from a calyx, resembling a flower's stem, ending with a four-petal fleuron each, different from the standard coiling volute. A third calyx rises from the acanthus collar, of which the fleuron's stem emerges. The abacus' fleuron is of five petals.³²⁴

³²³ Ronczweski 1923: 122 – 124, 129 – 132; all capitals were mentioned to be a production of the Augustan period.

³²⁴ Pensabene 2018: 52–54.

- The Villa Oplontis Group IV from Pompeii, although not Augustan and is dated after the AD 62 eruption – probably AD 79, follows the same schematics of the previous group. It is a single unique capital (Figure 174) that combines both the orthodox style of Roman Corinthian capitals and the floral-decorated capitals from the same site. Both volutes and helices, ending with floral motifs covering the coiling endings, emerge from the same acanthized calyces, surmounting a fluted cauliculus. The acanthus collar is also a single row of alternating acanthi and palmette leaves. The abacus is decorated with both Ionic and Doric motif. The central fleuron is large, placed on both the abacus and the upper part of the kalathos, with its stem emerging from the capital's collar; the latter is decorated with two semi-leaves.³²⁵
- A four-petal, rosette decorated capital from the Museum at Seville (Figure 175).



Figures 172-4. (left, middle left and middle right) Alexandrian Type III Floral capitals from Pompeii (Ronczweski)

Figure 175. (right) An Alexandrian Type III Floral capital from Seville (Behemerid)

Type IV (Double S) Alexandrian-based, Floral capitals³²⁶

- Interior capitals of the Temple of Mars Ultor, Rome (Figure 176).
- The Lesser Propylon of Eleusis, Athens (Figure 177).
- The outer volutes of the internal arc pilasters from the Augustan Arc at Susa (Figure 178).
- A pilaster found at the Lateran Museum, Rome (Figure 179).



Figure 176. (left) An Alexandrian Type IV Floral capital from Rome (Wikipedia)

Figure 177. (middle left) An Alexandrian Type IV Floral capital from Pompeii (Robertson)

Figures 178-9. (middle right and right) Outline of two Alexandrian Type IV Floral capitals from Italy (Ronczweski)

³²⁵ Pensabene 2018: 54.

³²⁶ Ronczewski 1923: 146–157; Behemerid 1983b: 86–88; all capitals were mentioned to be a production of the Augustan period.

Group II

The second type is also adorned with floral-decorated helices. However, each helix stem is divided into two sub-sections, of which resulting into a double floral-decorated helices; a total of four rosettes on each side of the capital. Based on Ronczewski, design "a" is an inverted S-shaped, while design "b" is a Greek letter-like "ε" design (Figure 180).

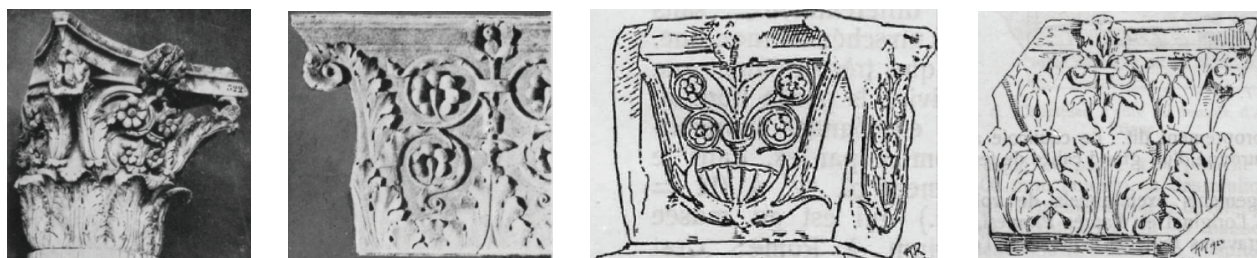

Figure 180. Outlines of the orientations of helices and volutes from Group II (Ronczewski)

- Design "a": A capital in the National Roman Museum (Figure 181).
- Design "b": A capital (Figure 182) and a pilaster (Figure 183) on display at the Lateran Museum in Rome.³²⁷

Group III

A third, unique type is found at Naples (Figure 163). It resembles the canonical capital; however, both helices and volutes are removed. The acanthized calyces are enlarged towards the abacus, and each calyx edge, forming fake volutes and helices. The latter is linked by a ribbon; a feature of orthodox canonical capitals found on the Iberian Peninsula.³²⁸ This capital resembles the All-Acanthus type of Corinthian capitals, which will emerge in the Late Roman period – see p. 142ff.



Figures 181-4. Examples and outlines of capitals from Groups II and III Augustan Roman Floral (Ronczewski)

Alexandrian and Egyptian Corinthian Capitals between 1st Century BC and 1st Century AD

After discussing both of the Late Republican and Augustan periods regarding the Corinthian capitals, it is important to compare them to their contemporary models from Egypt, generally, and in Alexandria, specifically. Roman presence in Egypt had its footing before Augustus' accession to the Roman Imperial throne. In the late years of the Republic, Caesar's presence in Alexandria was essential to stabilize the royal turbulences between Cleopatra VII and her brother Ptolemy XIV, since alliance with Egypt was essential for trade, especially grain supplies. This so-called alliance or Roman presence remained until the Battle of Actium, the defeat of the forces of Cleopatra and Mark Antony, and the annexation of Egypt as a Roman province in 30 BC.

This period between c. middle of the 1st century BC and c. middle of the 1st century AD was a period of architectural confusion for researchers, since it was a period of extension for the Ptolemaic Corinthian capital designs. Therefore, it was not easy to distinguish which capitals belonged to the Late Ptolemaic period and which to the early few decades of the Roman Empire under Augustus. It came to my attention how researchers like Pensabene and Tkazcow, while documenting archeological fragments – Corinthian capitals in regards of this study, that a certain category of capitals were dated between the 1st centuries BC and 1st century AD, without mentioning a specific century or year. In other sections, some capitals might stretch for two centuries as well; however, they are either Hellenistic or Imperial Roman, but never stretching between

³²⁷ Ronczewski 1923: 122, 123.

³²⁸ Ronczewski 1923: 129-131.

two eras, as in this case here. Therefore, it was important to isolate these capitals and study them separately after analyzing the Corinthian capitals in regards and in light of both Hellenistic and Roman styles and designs.

As in the previous chapter, I shall follow the division and categorization of the decorative elements of the capitals presented by Pensabene and Tkazcow, as well as all possible capitals from in Alexandria through the Graeco-Roman Museum and other capitals across Egypt. I shall be tracking each decorative element and trace it to either the already-existing Ptolemaic influence and/or the newly introduced canonical Augustan design of Roman Orthodox Corinthian capitals. It is important to bear in mind that this period is not only a period of confusion but also a period of transition from the Ptolemaic period into the Roman one. However, few examples at hand, the Augustan period – the embodiment of the Julio-Claudian and the 1st century AD, since Augustus was the first and main contributor of architecture in Egypt, and almost no other Julio-Claudian emperor after him with a worth-mentioning monument – not having a grand impact over Alexandria and Egypt, was the initial step to the development of the Corinthian capitals in Egypt.³²⁹

Following the same division presented in Chapter I – the few capitals from the Augustan period will be discussed separately – that are Hellenistic/Ptolemaic in their design, but fall within the period of confusion we are discussing in this section. Afterwards, the Roman models from Alexandria and Egypt, attributed to Augustus, will be discussed in light of how they are similar or different from the canonical capitals from Rome and the imperial provinces. The description of these categories is already presented in the previous chapter. Also, it is important to note that Pensabene, whom I base this study on his great work, does not describe this example as Roman or Augustan, but rather as Late-Hellenistic.³³⁰

The Four Types of Corinthian Capital Decorative Elements, in Regards of Designs and Proportions (Alexandria):

Type I Alexandrian Corinthian Capitals

Under Augustus, we can see a continuation of certain capital designs from the Type I Alexandrian capitals. From the **first subcategory**, however limited, we can notice a continuation of the capital design with **convex helices, wrapped with cauliculi**³³¹ – see p. 32ff.

Figures 185 and 186: Figure 185 has fluted helices, while those of Figure 186 are smooth. The leaves of the acanthus collar of both capitals have two pairs of leaflets. Figure 164 has semi-closed round sinuses, while Figure 186 has fully closed and round ones.

Also, we can see limited continuation of the **second subcategory**. We can notice how both volutes and helices are wrapped in cauliculi. Also, the leaves of the double acanthus collar are of double pairs, with triple leaflet endings and semi-closed sinuses – see p. 36ff.

Figure 187: It shows the rest of the capital's upper motifs. From this example, we can deduce that it follows the same Hellenistic type presented through Figures 29 - 32 – see p. 37. Both the helices and volutes are separated, wrapped with acanthized cauliculi each. A flattened acanthus leaf surmounts the central leaf of the upper row of the collar. The only difference is the presentation of the fleuron's stem, parting the helices with a distance.

³²⁹ McKenzie 2007: 148, 150. Also see cat. no. 73-86.

³³⁰ Pensabene 1993: 152, 163.

³³¹ For more, see Pensabene 1993: 353, 357, 367; cat. no. 182, 201, 246.



Figures 185-7. *Type I Alexandrian Corinthian capitals from the Augustan period (Pensabene)*

Type II Alexandrian Corinthian Capitals

Examples of this category follow the same design of the Type II Alexandrian capitals. By following the same description presented in Chapter I, we can realize how the design of the acanthus collar changes. Figures 188 and 189 have drill-holed sinuses between the leaflets, while their Hellenistic counterparts are closer to almond-shaped, open sinuses, rather than enclosed round ones. Only Figure 189 has a collar of alternating acanthi and water plants.³³²

Figures 188 and 189: Like the previously mentioned Hellenistic examples from this category, both helices are presented back-to-back, emerging directly from the central leaf of the upper row of the acanthus collar. The presentations of volutes varied between cauliculi-wrapped volutes (Figure 188) or water plant volutes (Figure 189).

Figure 190: This capital follows the same central motifs of the previous and the Hellenistic examples from the same category. However, it is decorated with water plants for both the volutes and the acanthus collar, as the collar's water plants alternate in position with the acanthus leaves.



Figures 188-190. *Type II Alexandrian Corinthian capitals from the Augustan period (Pensabene)*

Type III Alexandrian Corinthian Capitals

This type follows the Hellenistic category of capitals with standard, non-interlocking helices. The helices are close, but not attached, to the abacus. Like the Type II capitals from the Augustan period, the sinuses between the acanthus leaflets are drill-holed, not like the almond-like, semi-opened sinuses from their Hellenistic counterparts. There are examples from both Alexandria and Dandara, where both categories are a close continuation and a preservation of the Hellenistic designs for Type III Alexandrian capitals – see p. 39ff.

³³² Pensabene 1993: 114; for more examples, see Figure 376.

Figure 191: The example at hand shows double volutes, wrapped with fluted cauliculi. The capital is a perfect Hellenistic adaptation, but with dill-holed sinuses.³³³ Personally, it is assumable that the wrapped cauliculi around the helices had taken a different style, where two little rims interrupt the middle thereof of the helices. In the Hellenistic period, we can see the wrapping floral motifs extend upwards, covering most of the helices. As for this example, we can see two little rims with prominent small leaflets. This motif is highly probable to be added by the Augustan period.



Figure 191. A Type II Alexandrian Corinthian capitals from the Augustan period (Pensabene)

Corinthian and Corinthianized Capitals from Upper Egypt

Hermopolis Magna

By the time of Augustus, Hermopolis was already a city with strong Ptolemaic footing. The city developed and flourished under the Romans, where they built their urban city beside the Ptolemaic complex.³³⁴ Although most of the great monumental landmarks of the city were added later in the 2nd and 3rd centuries AD, the Augustan presence left its mark.

Figure 192: This two-block capital, found at the Basilica, is a combination of two styles: the Alexandrian Hellenistic and the Eastern canonical Roman Corinthian from Athens. The capital, generally, is a rip-off from the Corinthian capital design used for the Odeon of Agrippa in Athens. The lower part, focusing on the design of the acanthus leaves, matches several Type I Alexandrian Corinthian capitals, most notably the Khartoum Square capital (Figure 22) – see p. 35. In both these two capitals from Athens and Hermopolis Magna, we can see how the acanthus leaves are both Hellenistic, with sharp leaflet endings, rather than the semi-round roman design; an imposition of the still-existing Hellenistic/Ptolemaic influence.



Figure 192. A Proto-Asiatic Corinthian capitals from Hermopolis Magna (Pensabene)

The Island of Philae

On the Island of Philae, a new tetrastyle temple was built within the Egyptian sanctuary, both in the time of Augustus, by Prefect P. Barbarus in 13/12 BC. The capitals of the temple were of two blocks each, carved using black granite or diorite capitals. Their design was based on a locally modified type of the Corinthian capitals. This capital was analyzed and discussed by Pensabene.³³⁵ It follows the same concept used for Nabataean Blocked-out capitals, where the outline of the capital is presented and the rest of the capital is left blank. However, this capital represents an unfinished acanthi collar, unfinished volutes, and a central area where the rest of the Corinthian capital elements were drawn.

Figure 193: This capital is one of those used for the Temple of Augustus of **Philae** in 13/12 BC. The two-block capital dimensions are interesting, where the lower block is slightly taller than the upper block; a Vitruvian proportion. The upper block shows only the abacus and the volutes, where the central area is left blank. It is probable that the internal motifs (helices, abacus flower, cauliculi and calyces) were either made of stucco or painted. It is difficult to identify which acanthus leaf type was used, since it was already simplified and corroded. Only the midribs of the leaves are visible. The capital was either intended to be simplified or left unfinished.

³³³ For analysis and other examples, see Pensabene 1993: 372; cat. no. 263–268.

³³⁴ McKenzie 2007: 158.

³³⁵ Pensabene 1993: 387; McKenzie 2007: 166, 168.

The capital is Alexandrian in its essence, where it imitates a capital from Alexandria (Figure 193A). This capital is also a two-block capital, where the upper drum has only the abacus and volutes, while the central blank part was painted. This capital was of the same design and conditions of the Philae capital. We cannot be certain which of them existed first, but the style existed in two distant cities at the far borders of Egypt.

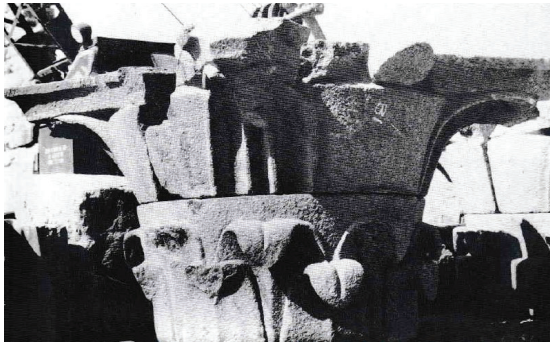

Figures 193-193A. *Two Blocked-Out-like capitals from the Augustan period, Philae and Alexandria (Pensabene)*

Another type of capitals, based on the Alexandrian Type III capitals had appeared on Philae. This design was already known to the Romans through the lyriform Floral capitals (Figure 194). Ronczewski mentions two examples; one from Philae, with double cauliculi-wrapped fluted volutes and fluted helices, while the other from Armant (near Thebes), closer to the Alexandrian model; water plant volutes.³³⁶ However, the Armant capital (Figure 194A) has helices of a new and different design of Type III helices, where they resemble the design of the so-called Oxford Standard Comma ", " rather than a lyre orientation. In a nutshell, it is a form of simplified helix design.³³⁷ This design can be found on Roman Floral capitals from Italy and the Iberian Peninsula – see above section II.2.D about the Roman Floral Corinthian(-ized) capitals from the Augustan period, Groups a and b (Figures 165–183).



Figures 194-194A. *Two Type III Alexandrian Corinthian capitals from the Augustan period, Philae and Armant (McKenzie and Ronczewski)*

Post-Augustan Corinthian Capitals until the 4th Century AD

In this section, I shall be discussing the evolution of the Corinthian capital designs under the successors of Augustus; from the Flavian dynasty until the Tetrarchy and Constantine the Great, who himself will be discussed as a link between the pagan and Christian periods of the 4th century AD. Since the Julio-Claudian dynasty did not have enough time to form a strong foundation or make attempts for architectural developments, and as we discussed how Augustus and Tiberius were the main figures, I shall highlight the

³³⁶ Ronczewski 1923: 140.

³³⁷ McKenzie 2007: 222.

emperors who made notable contributions. Their achievements vary among preserving the same developments, continuation of certain designs and slow evolutions across the years.

Unlike Augustus, who left his print in every province, some emperors have developments within Rome only, or the Italian Peninsula or Greece, etc... Therefore, some provinces will be of focus and great importance, while others will be ignored or discussed in other sections under the guidance of certain emperors; a result of certain focuses by these emperors and routes they had taken around the Mediterranean during their reigns.

Along with the Augustan capitals, a new type of imported marble capitals was introduced to Rome. This practice of importing or carving Asiatic type of Corinthian capitals did not hinder the usage of the canonical Augustan type; however gradually, and not permanently, it was to be abandoned. Generally, these capitals were imported complete or semi-finished. The importation included bases, entablatures, columns and other architectural decorative parts. However, all of these imported parts were massively reduced, except for the importation of the Asiatic capitals. Pensabene mentions that starting from the 2nd century and until the 4th century AD, 21 types of Asiatic Corinthian capitals were introduced to Rome. Before analyzing the important types that concern us, we must bear in mind that these capitals were introduced as "the Asiatic Corinthian capitals with thorny acanthus leaves", in addition to leaf separation of the lower collar; two common features introduced in all of the 21 types. Also, only two types were part of the 2nd century AD movement, while the majority of types belonged to the 3rd century AD, and a handful of types followed in the Constantinian period.³³⁸

Regardless of their great variations and the difficulty of mentioning every type in regards of definition and examples, I shall mention the important types, which are related to Alexandria. In the Alexandrian section, I shall discuss the direct relation between the Asiatic Corinthian capitals and the Alexandrian types in regards of origin, and which influenced the other. Regarding this section, I shall be addressing these Asiatic capitals as an import of Asia Minor, without referring either to type or its relation to its Alexandrian origin/counterpart.

Therefore, the Corinthian capital schematic designs could be divided as follows, each according to their chronological appearance within the Roman Empire as follows:

- The canonization of the Corinthian capital under Augustus and its dominance in Rome and the Western Provinces until Hadrian.
- The Agrippan version of the canonical Augustan capital design in Greece and how it was influenced by the Classical designs of Mainland Greece.
- The appearance of the Asiatic Corinthian capitals from Asia Minor and its importation into Rome – the appearance of the 21 types of Asiatic capitals – and how it overtook the canonical capital design.
- The dominance of the Asiatic capital designs under the Severans and Constantine I throughout the imperial provinces, leading to the appearance of proto-byzantine capitals.
- The Asiatic Corinthian capitals appearance in Alexandria and Egypt, and how it was affected by or different from the original Asiatic designs in regards of production and motif designs – see p. 107ff.

Rome and the Western Provinces

The Flavians and the Continuation of the Canonical Augustan Corinthian Capital within the Territory of the City of Rome

Vespasian, Domitian and the Reconstructions of the Roman Capitolium

After discussing the first two constructions and reconstruction of the Temple of Jupiter Capitolinus, mentioning how there could be two different theories for the Sullan/Catulan reconstruction; both theories intersect and agree about the following two imperial reconstructions. The third and fourth stages of

³³⁸ Pensabene 1986: 286, 297; for the detail analysis of the 21 types introduced to Rome, see 306–319.

reconstructing the temple were both carried out by the Flavian Dynasty, by Vespasian and ten years later by Domitian.

After Nero's burning of Rome and how it led to a civil war, the temple rebuilt by Catullus in 69 BC war was burnt in AD 69. After Vespasian's accession to the throne, he ordered the rebuilding of the temple in mid 70s AD. Ten years, following another fire, Domitian rebuilt the temple in AD 80, using the same columnar order established by Vespasian. We cannot exactly confirm how Vespasian rebuilt the Capitolium, but we are certain that Domitian following the most common decoration and columnar standards of the Flavian period; the Roman Orthodox Corinthian capitals.³³⁹

For the reconstruction by Vespasian, we have a medallion (Figure 174) with a representation of the Capitolium, decorated with Corinthian capitals. However, the reconstruction by Domitian might be the only phase with actual archeological evidence. The excavations carried out in 1860s and 1870s had unearthed a fragment of a massive Corinthian capital (Figure 175) at the site of the Capitolium. Allan Marquand had identified it as being – by current research standards – an Orthodox Corinthian capital of Pentelic marble.³⁴⁰ About a century after Marquand's excavation, and throughout the writings of Plutarch in *Life of Publicola*, we find that the reconstruction carried out by Domitian was ordered to be by using Pentelic marble. Marquand had attributed the fragment to Vespasian, but it is more reasonable to be from the final Domitianic phase. As for the temple/capital design, we can get a 4th century AD relief (Figure 176) representation from the reign of Aurelius, depicting the emperor himself making a sacrifice before the temple.³⁴¹



Figure 195. A medallion with a representation of the Captolium with Corinthian columns (Siwicki)



Figure 196. A lower fragment of a Corinthian capital unearthed at the site of the Capitolium (Marquand)



Figure 197. A representation of the Capitolium on a relief of Emperor Marcus Aurelius (Siwicki)

An interesting theory rises that within the third and fourth reconstructions by both Vespasian and Domitian, both reconstructions were carried out using Pentelic marble and capitals from the unfinished Athenian Temple of Zeus Olympius. Some scholars attribute the act itself of being a practice that begun with Sulla for the reconstruction of the temple. Historians like Plutarch and Tacitus, through Siwicki, mention how the capitals were moved, maybe reshaped and slightly reduced to fit the slender columns of the Capitolium. Although this theory was first presented by Plutarch, it might be a misreading of work, but it is a theory worth

³³⁹ Yegül and Favro 2019: 294; Siwicki 2020: 112–114, 175, 176.

³⁴⁰ Marquand 1898: 19–25.

³⁴¹ Plutarch, *Life of Publicola*, 15.3-5; Siwicki 2020: 115–118, 193.

considering and further studying.³⁴² However, as we previously refuted Sulla's connection with the Olympeion and the Capitolium, it seems that one way or another, the Olympeion is always connected to the Capitolium.

The Colosseum

The Colosseum was and still the largest amphitheater ever built in the Roman world, built and dedicated by Vespasian, probably before his death in AD 79. Moreover, it is thought that the upper two levels, along other modifications were completed under Domitian. The Colosseum was massive enough to be built over an artificial lake, where representations of naval battles were held as part of the public games. Regardless its function, the design of the Colosseum was "elliptical," divided into four levels. The columnar orders used on the exterior for each of the four levels were – bottom to top: Tuscan, Ionic, Corinthian, where the third and fourth levels were decorated with Corinthian semi-capitals and Corinthian pilasters respectively.³⁴³

By observing the Corinthian semi-capitals of the third floor (Figures 198 and 199), we notice that these capitals were decorated only with outlined motifs. The motifs of the canonical capital are represented. However, they are identifiable only through their outline. Probably, the architect did not bother putting much effort into carving these capitals, as they are viewed at a high altitude and only observed at a great distance.



Figures 198-9. A Corinthian capital from the third storey (left) and two Corinthian pilasters from the fourth storey (right) at the Colosseum (Paulding)*

Temple of Deified Vespasian

The Temple of Vespasian was built by Emperor Titus between AD 79 and AD 87. It was a pseudoperipteral hexastyle temple. The temple is considered one of the peak landmarks of its time. The Corinthian capitals are neatly carved, using the canonical Roman design. Currently, three columns (Figure 200) remain standing, re-erected in the 19th century AD.³⁴⁵ However, we can notice the general elongation of the capital and its motifs. The calyces are V-shaped, where their leaves being fluted and are brought close together, rather than being horizontally presented.



Figures 200. A Corinthian capital from the Temple of Deified Vespasian (Stamper)

The Nerva-Antonines and the Importation of the Asiatic Marble Corinthian Capitals

As previously mentioned, the dawn of the 2nd century AD has marked the arrival of a new type of Corinthian capitals, carved or semi-carved out of marble. These new Asiatic Corinthian capitals were different from the canonical Augustan capitals from the west, and even from the Agrippan model of Athens. This model was introduced at the eastern coast of the Aegean Sea, probably originated in Aphrodisias – at least most of them, where it was carved and shipped to Rome, and

³⁴² Stamper 2005: 152 – 154; Siwicki 2020: 193, 195.

³⁴³ Yegül and Favro 2019: 297, 298, 300, 303; Sear 2021: 138.

* https://paulding.instructure.com/courses/71196/pages/chapter-15-vault?module_item_id=346534

³⁴⁵ Stamper 2005: 159–161; Sear 2021: 145, 146.

later followed by the other imperial provinces, including Egypt, which I shall discuss thoroughly. There is a branch of study where these Asiatic types spread throughout the Western Provinces; however, the reason I will be tracking them in Eastern Provinces only is their relation to Alexandria. The other branch would require a more detailed study, where the research being centered about the Asiatic types, rather than the Alexandrian ones.

Forum Transitorium and the Temple of Minerva

The forum was also known as Forum of Nerva, began under Domitian in AD 85/86 and dedicated by Nerva in AD 97. The precinct of the forum was decorated with rich Corinthian columns, of which two of them are still standing, supporting part of the entablature (Figure 201). Also, at the north eastern side of the forum stood the Temple of Minerva; a hexastyle temple, decorated with canonical Augustan Corinthian capitals of the same design as those from the Forum of Nerva. Unfortunately, the temple was partly demolished during the 16th century AD, as its stone bricks were used for the construction of the Aqua Paola fountain; one of the Ancient Roman landmarks rebuilt during the Renaissance period.³⁴⁶



Figures 201. A Corinthian capital from the Forum of Nerva (Stamper)

The Pantheon

The current Pantheon was built on the site of the original Pantheon by Agrippa, which stood until AD 80. The Trajanic/Hadrianic Pantheon began with Trajan, but was burnt and then rebuilt a second time around AD 116–118. It was completed under Hadrian between AD 118 and AD 128.³⁴⁷

The architects of the Pantheon under Hadrian had used the canonical Corinthian style; however, it is considered a new step in its evolution and usages. The temple, generally, and the capitals, specifically, was modeled after both the Capitulum and the Temple of Mars Ultor – see Figures 78-82, 86 for design – not just for the design, but also the dimensions; exterior/portico (Figure 202) and interior/rotunda (Figure 203) capitals, and interior pilasters (Figure 204).³⁴⁸ The same design of capitals was used for both the capitals of the portico and the interior of the Rotunda – the canonical Augustan type, where the latter was smaller in size; 1.64m in height for the portico capitals and 1.26m for those of the interior.³⁴⁹

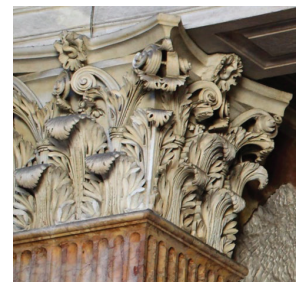

Figures 202-4. Interior and exterior Corinthian capitals from the Pantheon (Pinterest/WPF)*

³⁴⁶ Stamper 2005: p. 161, 163, 165–167; Yegül and Favro 2019: 312–314.

* <https://www.pinterest.com/pin/472455817131925437/>

<https://www.wallpaperflare.com/rome-pantheon-columns-capitals-corinthian-acanthus-scrolls-wallpaper-wkjri>

³⁴⁷ Yegül and Favro 2019: 355, 356, 358–360; Sear 2021: 168;

According to a more analytic study, it appeared that the bricks were laid in AD 114–116, and stamped in AD 117–118. Therefore, the Pantheon was only completed under Hadrian between AD 118 and AD 128; a reason of finding the dedication inscribed over the entablature to be holding Agrippa's name, which was a humble act by Hadrian. See Stamper 2005: 186–187;

³⁴⁸ Stamper 2005: 186–190.

³⁴⁹ Jones 1991: 95.

Temple of Venus and Roma

The Temple of Venus and Roma was among the first and only few projects carried out by Emperor Hadrian in Rome in 120s AD.³⁵⁰ The building of the temple, although laid in AD 121, was inspired by several Greek temples, especially the Olympeion (Figure 11), after Hadrian's visit to Greece in AD 124, where Hadrian was keen on constructing a Hellenic temple in Rome, where the Olympeion served as its model.³⁵¹

The architectural materials for the capitals of the temple were described, being of "white Proconnesian marble imported from Asia Minor" and the same size of those from the Olympeion, pushing some scholars to think that Hadrian moved some capitals from Athens for the building of this temple. The capitals were also different from the standard Augustan canonical Corinthian capitals, paving way for a more elegant design to appear which will be seen later at the Temple of Deified Hadrian – see below. Moreover, the temple has close resemblance to the Porticus Octaviae by Augustus – see above p. 73 and 82.³⁵²

Hadrian's Villa, Tivoli

Hadrian's Villa in Tivoli is one of the masterpieces of residential architecture, regarding both scale and design. The site was known to house residences of Roman Republic governors and later, Roman emperors. Under Hadrian, the villa was built on two phases; the first being between AD 118 and AD 125, and the second between AD 125 and AD 133.

From my point of view, the villa could be considered a residential open-museum that holds different sorts of decorative art marvels; from architectural designs to mosaics, sculptures and several buildings that include an Academy, a theater, a representation of the Alexandrian Sarapeum, etc... The villa is a goldmine of various Corinthian-related capitals. Unfortunately, none of them is related to the Alexandrian types. However, their varieties reflect the wide knowledge of the Roman artists in regards of the Corinthian and Corinthianized types. The Corinthianized capitals from Hadrian's Villa deserve a study on their own and tracing of their origin, in case of any Hellenistic influences.

According to Dio Cassius, the construction of the temple was unusual, almost as huge as the Temple of Artemis in Ephesus, and a combination of both western and eastern architectural characteristics; a step towards "pan-Hellenism," since Hadrian studied in Athens and was greatly affected by its culture. This indicates how Hadrian wanted the temple to be as close as possible to the Hellenized temples of the East, especially those more closer to the Asia Minor temple designs.

The Canopus or the Scenic Canal is an elongated canal/pool representation of the city of Canopus near Alexandria. It represents the Nile or a canal from the Nile, ending with a construction that represents the Alexandrian Sarapeum. The canal is surrounded with a colonnade to the eastern side, where the northeast side is decorated with columns supporting "archivolts and straight entablatures." The capitals from this section are of the canonical Corinthian type (Figure 205).³⁵³

³⁵⁰ Stamper 2005: 209, 212, 259 footnote 16; Yegül and Favro 2019: 353; Sear 2021: 170, 172; Probably erected in AD 125/126, dedicated in AD 135–137, almost finished in AD 136/137, but was completed under Antoninus Pius in AD 140–145; later burnt and re-erected by Maxentius in AD 307. The temple was dedicated to the cult of worshipping the deified image of the city of Rome, which was already known in the Eastern Provinces, and the goddess Venus, patron goddess and "mythical ancestor" of the Julio-Claudians, founders of the empire; hence Hadrian himself. The cult was more local than being an imperial one.

³⁵¹ Stamper 2005:206, 207, 210.

³⁵² See Stamper 2005: 210–212; Yegül and Favro 2021: 354.

³⁵³ Yegül and Favro 2019: 373, 374, 376, 381, 383, 384; Sear 2021: 178.

Temple of Deified Hadrian

The Temple of Divus Hadrianus was constructed AD 139 by Antoninus Pius, in memory of his father, and was dedicated in AD 145. The temple remains partially within the 19th century stock exchange building, where eleven columns remain intact. The design had followed the same Roman and oriental combination of styles, where its capitals (Figure 206) remained within the same **canonical Augustan design** used for the Temple of Venus and Roma – see p. 106.



Figure 205. Corinthian columns supporting a semi-arched entablature (Wikicommons)

Figure 206. A Corinthian capital from Divus Hadrianus (Wikimedia)

Temple of Faustina and Antoninus Pius

The temple (Figure 207) was built in honor of Faustina the Elder after her death in AD 141, dedicated in AD 145, and Pius' name was later added in AD 161 after his own death. The main reason behind the temple's preservation is its conversion into the Church of San Loranzo in Miranda. The temple is prostyle hexastyle; six frontal capitals, two behind the rear columns and pilasters on its wall; all following the same canonical Augustan Corinthian capitals.³⁵⁴



Figure 207. Capitals of the Temple of Faustina and Antoninus Pius (CRT)*

The Asiatic Types of the Corinthian Capitals

The first type of the Asiatic Corinthian capitals appeared between AD 130 and AD 160. Probably, this is the earliest example of this type of capitals, with assumption of being an original product of Aphrodisias. The example presented by Pensabene is a capital from the baths at the Forum of Ostia (Figure 208). He also hinted the relation and similarities between this type and the Nymphaeum of Herodes Atticus from AD 150, which explains the slight similarities to the capital from the Agrippan Odeion –



Figure 208. An Asiatic Corinthian capital from Ostia (Pensabene)

* <https://colosseumrometickets.com/wp-content/uploads/2018/09/Temple-of-Antoninus-and-Faustina.jpg>

³⁵⁴ Stamper 2005: 213, 214–216; Yegül and Favro 2019:399–401; Sear 2021: 181, 184.

see Figure 161. According to the design of the capital, as well as the description provided,³⁵⁵ we can analyze the capital as follows:

- The lower acanthus collar has its leaves separated; S-shaped acanthi.
- The upper acanthus collar has its ribs elongated; its lower leaflets rise from behind the leaflets of the lower collar and up towards the upper leaflets, forming elongated and inverted-triangular sinuses.
- Standard volutes and helices, emerging from broadened acanthized calyces.
- Reduced, non-fluted cauliculi are surmounted with the broadened calyces.

Therefore, we can assume that from the same period Hadrian was touring the Eastern Provinces, these capitals were introduced, or as I assume that it happened on the orders of Hadrian, to Rome.

Another type of Asiatic Corinthian capitals were introduced also between AD 130 and AD 160. The example at hand is a capital on display at the museum in Brindisi (Figure 209). Similar capitals can be found at the Temple of Deified Trajan at Pergamon – see Figure 219. Based on the example and the provided description,³⁵⁶ we conclude that:

- The lower acanthus collar's leaves are separated; S-shaped acanthi.
- The lower acanthus collar form vertical sinuses with the lower leaflets of the upper collar.
- The cauliculi and calyces are replaced with acanthus leaves, of which the volutes and helices emerge, as well as replacing the fleuron's stem. The latter is notability reduced.



Figure 209. An Asiatic Corinthian capital from Brindisi (Pensabene)

From the Reign of the Severans to Constantine the Great

Rome and Italy

Under the Severans, Rome had witnessed a great wave of architectural constructions and restorations. Among their achievements were the Septizodium; a three-level fountain, by Septimius Severus, with an Asiatic façade; the two-level nymphaeum by Alexander Severus, with its four free-standing columns flanking its three arches; and the Temple of Sol Invictus from the same period.³⁵⁷ Although no clear representations of the capitals used for the three previously-mentioned monuments, we can deduce the usage of the Asiatic types of Corinthian capitals, following other monuments under both emperors – see p. 107ff.

After the anarchy period and the rise of the tetrarchs, Maximian built the Baths of Diocletian in AD 298 and dedicated it to Diocletian in AD 305/306. Regardless its massive scale that shadowed the Baths of Caracalla, what concerns us is the interior columnar order. Based on a reconstruction published by the Royal Academy of Arts, from the Renaissance period by Van Noyen, two designs for Corinthian capitals (Figure 210) were used in decorating the Baths. The designs were based on the canonical Roman design, where two designs are represented with exaggerated-size volutes.



Figure 210. A sketch of the two Corinthian capital models from the Baths of Diocletian (Van Nayan)

³⁵⁵ Pensabene 1983: 306; See Type I.

³⁵⁶ See Type VII in: Pensabene 1983: 310.

³⁵⁷ See Yegül and Favro 2019: 800, 801, 802, 806, 807; Sear 2021: 262, 263, 266;

The Septizodium was dedicated in AD 203. The façade of the Septizodium, being Asiatic in its design, reflected Severus' PanHellenic nature. Based on reconstructions and the Marble Plan, the façade was adorned with Corinthian capitals. The columns of the Nymphaeum of Alexander Severus were decorated with Corinthian capitals. The Temple of Sol Invictus from the same period, presented on a coin from AD 222, was the hexastyle peripetual temple was built using the same Corinthian columnar order.

Constantine the Great built his arch in Rome in AD 315. The arch was commemorated to his triumph over Emperor Maxentius; the first ever of its kind, a Roman triumph over another Roman. The grandiose of the arch was decorated with four freestanding columns with canonical Roman Corinthian capitals on both façades.³⁵⁸ The capitals (Figure 211) of the arch are not probably original, but rather re-used. It appears that in the time of Constantine the Great, it was popular to dismantle Roman monuments and re-using them; the same happened in the building of Constantinople, which shall be discussed in the next chapter. Nevertheless, the capitals of the Arch of Constantine appear to be from the Hadrianic period in regards of design and proportions. It is not worth discussing here, only to validate the re-usage of canonical capitals in the time where the Asiatic ones dominated.³⁵⁹



Figure 211. A sketch of a Corinthian capital from the Baths of Diocletian (Wikimedia)

Regarding the Asiatic Corinthian Capitals, there are several examples; however, they are not worth mentioning. Only two examples are related to Alexandria – which I shall be discussing in the section about Alexandria. Two single collar capitals from the 4th century AD and one example from the late 4th/early 5th century AD, of which the latter is related to the Late Roman/Byzantine period – see later in Chapter III.

The West

In AD 305, after stepping down from the tetrarchy, Diocletian retired and built his palace in Spalato, Croatia. Among the large palace's construction was the north gate, known as the Golden Gate (Figure 212). The gate was decorated with "Corinthian arcades," resembling those from the Canopus at Hadrian's villa – see p. 106ff. Although the capitals were simplified, traces of motifs were visible, reflecting the usage of the canonical type. Moreover, the façade of frontal courtyard (Figure 213) was decorated with the same Corinthian arcades; however regular in size.³⁶⁰

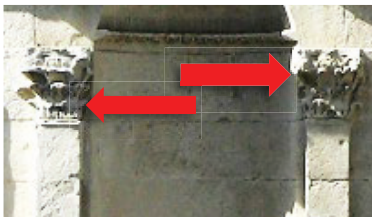

Figure 212. (left) A decorating arch from the Golden Gate, Palace of Diocletian (Wikimedia)



Figure 213. (right) A Corinthian capital from the Palace of Diocletian (Wikimedia)

The Eastern Provinces and the Perseverance of the Hellenistic Spirit

Within the imperial period, we see how the Eastern Provinces were a center of both focus and attention for Roman emperors, especially Hadrian. If Italy and the Western Provinces were the focus of Augustus, then the East was architecturally shaped and spiritually flourished under the Antonines, along with the rise of Pergamon, the Roman puppet state.

Although there were various contributions in the Eastern Provinces since the dawn of the Republic, those under Hadrian are the most important. Along with Hadrian's contributions to Rome, he left his mark in the East; the source of his influences, as we previously mentioned, over the entirety of Roman architecture –

³⁵⁸ Yegül and Favro 2019: 816, 845.

³⁵⁹ Jones 2000: 50, 51, 53, 57, 63, 64.

³⁶⁰ Yegül and Favro 2019: 817, 820.

Corinthian capitals in this case – during his rule. To ensure both his dominance and deeply-embedded Hellenic roots, Hadrian carved the famous inscription on his arch-gate "This is the city of Hadrian and not of Theseus."

Athens, Greece – The Hadrianic Period

The Library of Hadrian was a name given to the most glorious of Hadrian's constructions in Athens as stated by Pausanias, through Yegül and Favro. The Library was constructed between AD 117 and AD 138. The entire exterior of the building was decorated with free-standing Corinthian capitals (Figure 214). Only seven of these capitals were re-erected and still currently standings and visible by the northern side of the Library's proylon.

The Arch-Gate of Hadrian was constructed in Athens AD 131/132 by the Athenians in Honor of the emperor, and to mark the borders of the newly expanded city under Hadrian. The two-level arch-gate is decorated with free-standing Corinthian columns, with capitals of the canonical Roman type. Only the central pair of columns remains, while the exterior ones are missing. A second row of square-shaped columns are decorated with Corinthian pilasters of the same design (Figure 215).³⁶¹

The Temple of Zeus Olympius (see p. 26-7; Antiochus IV in Chapter I and its relation to Rome earlier in this chapter) is a temple that was discussed several times from Classical to Hellenistic and Republican Roman periods. Unlike the previous periods, where the temple was partially built or partially stolen or moved, Hadrian had the honors of completing the temple after almost seven centuries since its foundations were laid by Peisistratus. It is highly probable that the capitals seen at the site today are those carved upon Hadrian's orders of completion (Figure 216), and not those by Cossutius under Antiochus IV.³⁶²

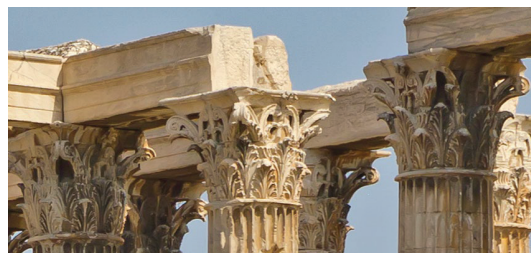
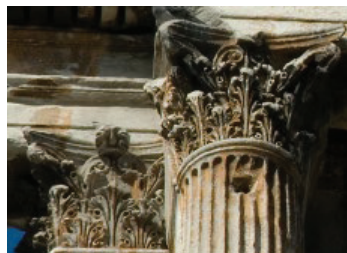
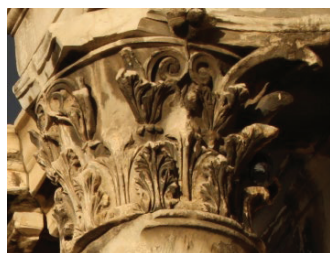

Figure 214. (left) A Corinthian capital from the Library of Hadrian (Wikipedia)

Figure 215. (middle) A Corinthian pilaster and capital from the Gate of Hadrian (Wikipedia)

Figure 216. (right) Corinthian capitals from the Olympium (Wikipedia)

The Philopappus Monument is one of the most interesting monuments in Athens. It was erected in AD 114–116 by Antiochus Pilopappos, an exiled prince of the Late Hellenistic kingdom of Commegene, Eastern Anatolia. The tower-tomb was a mixture of Commegene and Seleucid arts. The upper level of the monument was decorated with four Corinthian pilasters. The pilasters (Figure 217) follow the same schematic design of Roman Corinthian capitals from the Western Provinces – see the Agrippan Odeion, Figure 161.³⁶³

The Nymphaeum of Herodes Atticus (Figure 218) was built by the wealthy philosopher of the same name from the Attic region in AD 150. The Nymphaeum was a tholos-like, semi-circular columnar exedra. The whole monument was decorated with Corinthian capitals of the Hadrianic Hellenistic-influenced design.³⁶⁴ It is

³⁶¹ Yegül and Favro 2019: 583, 585; Sear 2021: 240.

³⁶² Yegül and Favro 2019: 583, 585, 587; Sear 2021: 239–242.

³⁶³ Fyfe 1936: 67; Yegül and Favro 2019: 592.

³⁶⁴ Yegül and Favro 2019: 589, 590.

probable that the design of the capitals of the Nymphaeum had influenced the first type of Asiatic Corinthian capitals in Rome – see p. 107-8; Figures 208–209.



Figure 217. (left) A Corinthian capital from the Library of Hadrian (Stewart and Ravett)

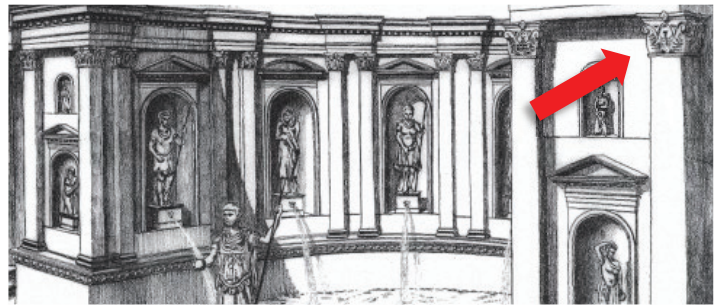

Figure 218. (right) A Corinthian pilaster and capital from the Gate of Hadrian (Yegül and Favro)

Asia Minor – The Hadrianic Period

The Temple of Deified Trajan was built on the Acropolis of Pergamon by Hadrian. The temple was peripteros, with two pilasters behind the freestanding columns at the side of the façade. The importance of the temple lies in its Asiatic Corinthian capitals (Figure 219) and its relation to the Asiatic Corinthian capitals in Rome,³⁶⁵ as a source of inspiration or counterpart, and Temple N1 in Side – see below Figure 223.

The Temple of Hadrian in Ephesus (Figure 220) was a tetrastyle temple; two central free-standing columns and two in-antis capitals on square-shaped columns. The temple was built between AD 128 and AD 138. The design of the temple's façade resembles the colonnade from the Canopus of Hadrian's villa in both capital design and entablature – see Figure 205.³⁶⁶ According to Pensabene, this design of Asiatic Corinthian capitals introduced to Rome, between AD 130 and AD 170, was originally based of the capitals of this design. The same design appeared in Side in the early years of the 2nd century AD – see below Figure 223. The design of the capital is based on widening the upper part of the kalathos, reducing the space of between the leaves of the lower acanthus collar that they touch at one leaf or two, acanthized calyces, and prominent acanthus leaves from the background intersecting with the upper collar acanthi, forming oval-shaped sinuses.³⁶⁷ Same capital design is used for the Celsus Library – see below Figure 221.



Figure 219. (left) Two Corinthian capitals from the Temple of Deified Trajan (Yegül and Favro)

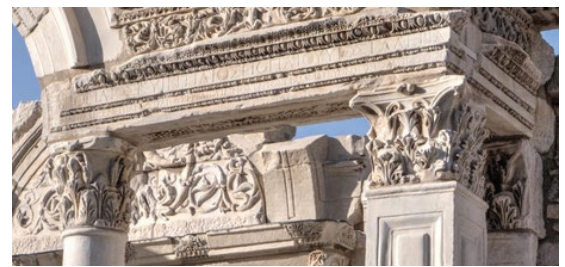

Figure 220. (right) Corinthian pilaster and capitals from the Temple of Hadrian (turkisharchaeologynews.net)*

* <https://turkisharchaeologynews.net/object/temple-hadrian-ephesus>

³⁶⁵ Pensabene 1983: 310; See Type VII.

³⁶⁶ Sear 2021: 247.

³⁶⁷ Pensabene 1983: 312, 313; see Type X.

The Celsus Library in Ephesus was a library and a funerary monument dedicated to Celsus the philosopher. The two-storey façade was decorated with Asiatic Corinthian capitals (Figure 221) on its second level; capitals carved with great skill and rich in motifs like those from the Temple of Hadrian – see above Figure 220.³⁶⁸

Another Gate of Hadrian was built in Ephesus; a contemporary to the one in Athens. The upper level of the gate is decorated with slim and cylindrical columns with a type of Asiatic Corinthian capitals (Figure 222) – based on the acanthus collar design, since the upper parts of all capitals are destroyed.³⁶⁹ The capital rests over a Composite pilaster on the other side.

Temple N1 in Side, probably dedicated to Athena, is a Corinthian temple that had abandoned the Hadrianic Hellenized influence of architecture. It shifted towards the Pergamese Temple of Deified Trajan in regards of the Asiatic Corinthian capitals design (Figure 219) – see above the relation between the two temples dedicated to deified Trajan in Rome and Pergamon, and their relation to the façade of the Temple of Venus and Roma, and the Porticus Octaviae.³⁷⁰ The capitals belong to the Asiatic Corinthian capitals (Figure 223), since both types share the same acanthus design, with traces of calyces;³⁷¹ the only two identifiable part of the capitals, along broken motifs of the common helices design, omitting the option of being tongue-shaped.

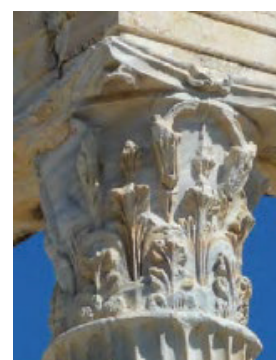
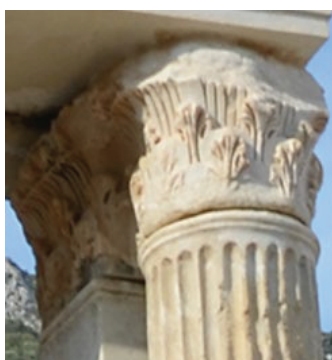
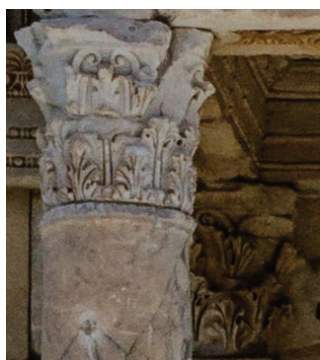

Figure 221. (left) A Corinthian capital from the Celsus Library (Wikimedia)

Figure 222. (middle) A Corinthian pilaster and capital from the Gate of Hadrian (Wikimedia)

Figure 223. (right) A Corinthian capital from Temple N1 (Yegül and Favro)

The Temple-Tombs in Cilicia are two Hellenistic monuments from the Roman period. The cell of the tomb is decorated with two Corinthian pilasters on the frontal side walls of the façade, and free-standing columns with Asiatic Corinthian columns (Figure 224);³⁷² probably there was another column at the left side, but currently missing.³⁷³ The capitals from the tomb have reduced helices and diamond-shaped sinuses between the leaflet endings of the lower collar; a Roman/Alexandrian feature. The temple adjacent to the tomb has four freestanding Corinthian columns of the same capital design (Figure 224), and two simplified anti-capitals behind the outermost capitals. Both monuments follow the same schematic design from Ephesus – see above Figures 220–222.³⁷⁴

³⁶⁸ Yegül and Favro 2019: 691, 692; Sear 2001: 247; see Type X in: Pensabene 1983: 312, 313 for similarities.

³⁶⁹ Yegül and Favro 2019: 671.

³⁷⁰ Yegül and Favro 2019: 642, 648, 650.

³⁷¹ See Types III and IV in: Pensabene 1986.

³⁷² see Type X in: Pensabene 1983: 312, 313.

³⁷³ Fyfe 1936: 62, 63; Yegül and Favro 2019: 640.

³⁷⁴ Pensabene 1986: 313.

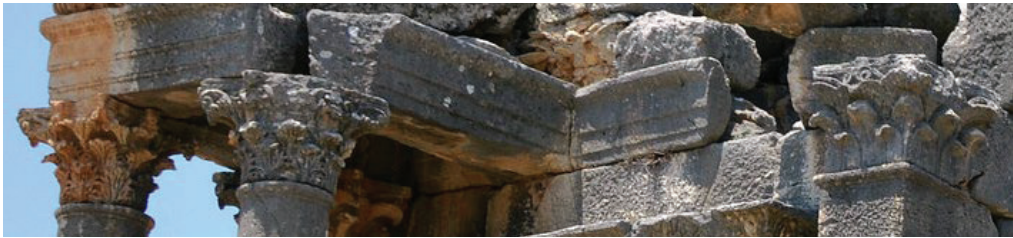
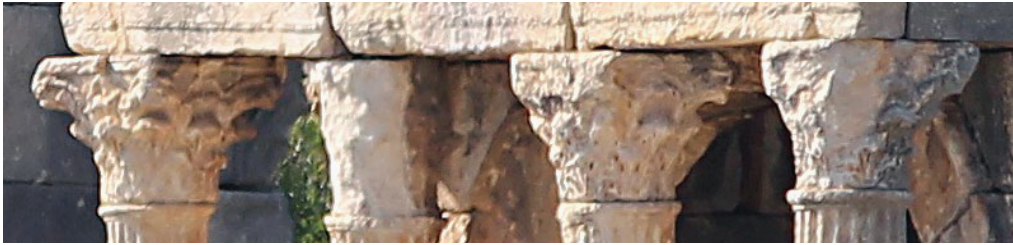

Figure 224. (upper) Corinthian capitals of the upper level of the Imbriogon/Demircili 2 Temple-Tomb (Wikimedia)

Figure 225. (lower) Corinthian capitals of the upper level of the Demircili 1 Temple-Tomb (Wikimedia)

The Levantine Coast – The Antonine and Severan Periods

The Temple of Bacchus in Baalbek was a peripteral octastyle temple, built in the 2nd century AD in a Hellenistic manner. Rich Corinthian capitals were used for the exterior peristyle. It was built within the same sanctuary and of the same design as that of the Temple of Bel, to its south. The cella walls are supported by columns and pilasters in-antis with rich Corinthian capitals (Figure 226), like those of the exterior peristyle.³⁷⁵

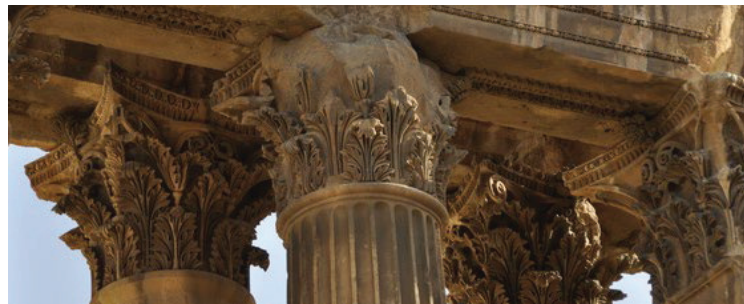

Figure 226. Corinthian capitals and a pilaster from the Temple of Baachus (Wikimedia)

The Temple of Bel in Palmyra had witnessed several renovations and architectural developments throughout the imperial period. Within the period between late 1st century AD and the 2nd century AD, a series of pilasters were added by the temple by its northern (Figure 227), southern, (Figure 228), and western (Figure 229) porticoes. These capitals follow the eastern design of the canonical Corinthian capitals; easily identified from the rounded tips of acanthi and the small separation between the central helices.³⁷⁶

³⁷⁵ Fyfe 1936: 38, 39; Yegül and Favro 2019: 742.

³⁷⁶ Schlumberger 1933: 296, 297.



Figure 227-9. Two Corinthian pilasters and a capital from the Temple of Bel (Schlumberger)

The city of Jerash had witnessed the construction of several Hellenistic-influenced Roman monuments in the 2nd century AD. The first is the Sanctuary of Zeus, originally a 1st century AD project under Tiberius, but the temple was completed in AD 163. The capitals (Figure 230) from the sanctuary are canonical Corinthian, but rather two-blocked capitals, and exterior naos pilasters of the same design. The other sanctuary is the Sanctuary of Artemis from the same city, erected in the 2nd century AD. The sanctuary is hexastyle peripteros, with free standing Corinthian columns (Figure 231). Its capitals follow the same design from the Sanctuary of Zeus. Also, another Arch of Hadrian was erected in AD 129/130 as a city gate and also a contemporary of the gates from Athens and Ephesus.³⁷⁷ However, the arch shows three different Corinthian capital designs (Figure 232), two on the lesser pediment, where one of them follows the Asiatic designs, and the second is a reduced capital with smooth, non-carved acanthus leaves.



Figure 230. (left) A Corinthian capital from the Sanctuary of Zeus (Wikimedia)

Figure 231. (middle) A Corinthian capital from the Sanctuary of Artemis (Wikipedia)

Figure 232. (right) Corinthian semi-capitals from the Arch of Hadrian (Wikipedia)

The Kalybe in Bostra is a small, semi-circular Nabataean/Hellenistic nymphaeum from the 2nd century AD.³⁷⁸ Interestingly, the capital (Figure 233) design is almost identical to the Anatolian capital design of the propylon of the Bouleuterion from Miletus, save for the central helices, which are of the normal size, and the acanthus leaves, which tend towards the Roman canonical design, rather than the freely-designed leaves from Miletus – see Chapter I, Figure 15.

The Thermal Basilica in Tyre, previously mistaken for a colonnaded street, offers a set of Corinthian capitals (Figure 234), dated to the early 2nd century AD. These sets of capitals are probably the prototype models for the type of Asiatic Corinthian capitals that were introduced in Ephesus at the Temple of Hadrian – see above Figure 220 – and in Rome in the 3rd century AD. There are slight differences from the capitals at Ephesus, like

³⁷⁷ Yegül and Favro 2019: 764–767.

³⁷⁸ Yegül and Favro 2019: 759, 761

the extra helices around the fleuron's stem, the presence of the fleuron's stem itself, and the two-leaf-shaped fleuron on the abacus. Also, the acanthus leaves of the lower collar are totally separated, and not semi-attached.³⁷⁹ Similar capitals will appear in Alexandria within the same period, under the category of Asiatic Corinthian Capitals, which will be discussed later thoroughly³⁸⁰ – see p. 121-4.

The octagonal Byzantine Martyrium in Tyre (Figure 235) is another example and a rare model, within the Levantine region. The capital is dated to the late 3rd century AD. It follows the design of the Asiatic Corinthian capitals with tongue-like helices, from the second half of the 3rd century AD. Same design will appear at the Arch of Septemius Severus at Lepcis Magna – see Figures 237A-B.³⁸¹



Figure 233. (left) A reconstruction Corinthian capital from Bostra (Butler)



Figure 234. (middle) A Corinthian capital from the Thermal Basilica (Kahwagi-Janho)



Figure 235. (right) Corinthian capitals from the Byzantine Martyrium (Kahwagi-Janho)

Therefore, within the 2nd century AD and beginning of the 3rd century AD, we can see how the Roman Empire shifted from the usage of the canonical design of the Roman Corinthian capitals towards the Asiatic types gradually. The West followed the canonical designs used in Rome without imposing any external influences, except from the Hadrianic period, where the influences were adapted from the eastern version of the canonical Corinthian capitals that began with Agrippa and his Odeion in Athens (Figure 161), and later followed by the Asiatic designs.

The Temple of Venus in Baalbek was a round-like, pseudo-circular, uniquely-designed, octagonal temple, built to the southeast of the Sanctuary of Jupiter in the early 3rd century BC. The tetrastyle façade, along with the temple's porch were decorated with free-standing Corinthian capitals (Figure 236).³⁸² Although it comes two centuries later after the construction of the Sanctuary, the design of its Corinthian capitals follow the same schematic design from the Temple of Jupiter – see above Figure 144.

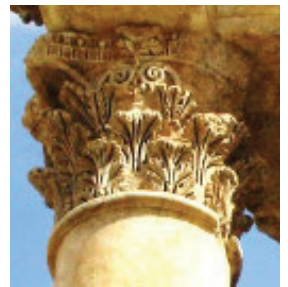

Figure 236. A Corinthian capital from the Temple of Venus (Wikimedia)

Lepcis Magna (from the African Provinces) during the the Severan Period

Like Augustus and the West, and Hadrian and the East, Septemius Severus was more concerned with Africa. Since he was an African-born Emperor from Lepcis Magna, it is obvious why he was concerned with his

³⁷⁹ Pensabene 1986: 312, 313; Kahwagi-Janho, 2014: 319, 320, 322–324; see Type X in: Pensabene 1983: 312, 313 for similarities.

³⁸⁰ Kahwagi-Janho, 2014: 320–327.

³⁸¹ See Type X in Pensabene 1986: 312, 313; Kahwagi-Janho, 2014: 319, 320, 322–324.

³⁸² Fyfe 1936: 44, 45; Yegül and Favro 2019: 743, 744.

hometown and being keen on preserving his relationship to the city. Also, it seems that Caracalla followed the same system of imposing his dominance by building triumphal monuments throughout the African cities. Therefore, the focus will be on the city of Lepcis, since it was the center of attraction for the Severan emperors of all African cities. Also, we can consider Lepcis Magna to be the embodiment of the African cities.

We must realize that the Corinthian capital designs did not appear in Africa with the Severans only. Several designs had existed since Carthage and all the way towards Hadrian. However, discussing these branches will require a special study and knowledge about Carthaginian art and influences from the African Provinces, like the case of the Punic-Hellenistic capitals from Volubilis. It is both important and interesting to track this branch of evolution, but it shall, unfortunately, drive us away from the Alexandrian focal center of this study, which I leave for other scholars to trace.

Originally, the city of Lepcis Magna was built in the early 5th century BC as a Phoenician/Punic colony. The city held a position of a post on the road between Alexandria and Carthage, thus flourishing under the latter until it fell to Rome. The evolution of the city began with Augustus, and flourished under Hadrian with the introduction of the using of marble. The city expanded during the 1st and 2nd centuries AD, under Hadrian, followed by Septimius Severus. As his hometown, Septimius Severus treated the city in a special manner, that he even celebrated one of his military victories there, rather than in Rome. Under the Severans, we can see how its architecture was close in resemblance to that of the Eastern Mediterranean, especially Asia Minor.³⁸³

The city of Lepcis Magna, like Rome, was introduced to several Asiatic types of the Corinthian capitals presented in Rome. The appearance of these types in Africa is based on two things; first, is about how Emperor Septimius Severus was concerned with his hometown, and second, with the arrival of artists from Asia Minor, especially from Aphrodisias, who trained local artists or carved these capitals within the city itself – exactly like the case in Rome.

The Arch of Septimius Severus is a four-way arch (Tetrapylon), erected in AD 203, in honor of the emperor's military victory and his visit to the city. The arch was built by architects from Aphrodisias, and was decorated with two types of Asiatic Corinthian capitals. The capitals of the freestanding columns supporting the broken arch (Figure 237A) are of the Asiatic Corinthian capitals. This type was originally presented in Rome in the second quarter of 3rd century AD. Its characteristics lie in the double lobes formed with the meeting of the upper two leaflet endings of the lower leaflet with the low-most leaf of the upper leaflet. Regarding the corner pilasters of the arch (Figure 237B), they follow a different Type of Asiatic Corinthian capitals (tongue-shaped helices and an upper acanthus collar with triangular, wide leaves); a design already presented in the city of Type by the beginning of the 2nd century AD – see above, i.e. Figure 234.³⁸⁴

The Numphaeum (Figure 238) was one of the constructions included in the Severan plan of expansion and decorations. The nymphaeum was a semi-circular exedra, decorated with marble columns with Asiatic Corinthian capital. Same design of capitals (Figure 239) was presented with the construction of the Severan Basilica. This design was introduced in Rome in the first half of the 3rd century AD. Its characteristics lie in the lower collar having shadowed background with smooth acanthi motifs, the upper collar ribs fading into the background, and the upper collar leaves have triangular outline.³⁸⁵

* https://www.researchgate.net/figure/Arch-of-Septimius-Severus-in-Leptis-Magna-Symbol-of-the-prosperity-of-the-ancient-town_fig3_343669119

³⁸³ Yegül and Favro 2019: 520, 522, 523, 525, 526, 530, 534.

³⁸⁴ Pensabene 1986: 306, 309; Yegül and Favro 2019: 530, 531; Sear 2021: 203. The capitals follow Types II and III of the Asiatic Corinthian capitals from Rome; after Pensabene.

³⁸⁵ See Type III in Pensabene 1986: 309; Yegül and Favro 2019: 531, 532.



Figures 237A-B. A Corinthian capital and a pilaster from the Arch of Septimius Severus (Researchgate)*

Figure 238. Two Corinthian capitals from the Nymphaeum (Yegül and Favro)

Figure 239. A Corinthian capital from the Severan Basilica (Yegül and Favro)

The Arcade of the Severan Forum is an extension to the Corinthianized Water-Plant capitals (Figure 240) that appeared since the 2nd century BC. Throughout the imperial period, these types of capitals had appeared in Athens (Figure 241), Smyrna (Figure 242) and Pergamon (Figure 243). The acanthized version of these capitals is known as "lotus-and-acanthus" capitals.³⁸⁶ In this 3rd century example of water-plant capitals, as in Tripolitania (Figure 244), the water plants or lotus leaves do not emerge directly from behind the acanthus leaves, but are rather separated by a lower blank background for the acanthi ending with a rim at the third of the kalathos' height. From the rim emerges the lotus leaves towards the abacus.



Figures 240-244. Several Palm capital designs from the Eastern Mediterranean: Lepcis Magna, Athens, Smyrna, Pergamon, and Tripolitania (Ronczewski, War-Perkins, and Yegül and Favro)

Therefore, we can conclude that by the time of Constantine the Great, there was a great reduction in the usage of the canonical Augustan Corinthian capitals. The reign of the Severans marked the emergence of the imported marble Asiatic Corinthian capitals into Rome and the provinces. The importation included local Asiatic artisans, probably from Aphrodisias, who both produced and trained local artists into carving these types of capitals. Also, the Asiatic Corinthian designs found their way into Alexandria and Egypt. The relation between the Asiatic and Alexandrian productions of such newly-introduced designs is to be discussed in the following section thoroughly.

Alexandrian and Egyptian Roman Corinthian Capitals

By the end of the Augustan period and the 1st century AD, the city of Alexandria had expanded beyond its Ptolemaic borders. This expansion was both physically and metaphorically. It is then when local limestone used for architectural decorations was replaced with imported Asiatic marble. Importation had included the semi-finished or finished Asiatic Corinthian capitals. This post-1st-century-AD period could be considered a period of Romanization, where Alexandria is submitted to the role of a receiver of a new art; same as the period under Alexander the Great and Ptolemy I. However, it is about Roman art rather than the Macedonian

³⁸⁶ Ronczewski 1923: 135; Ward-Perkins 1958: 66, 67; Yegül and Favro 2019: 532.

one. Also, the process of Romanization did not totally omit the Alexandrian spirit, since we can observe traces of Alexandrian and Ptolemaic architectural motifs on the local version of Asiatic capitals; regardless, we will notice a gradual reduction of the Alexandrian versions of the Corinthian capitals by the middle of the 2nd century AD.³⁸⁷

The evolution of the Corinthian capital was more complicated than Rome or Asia Minor or Lepcis Magna. As previously mentioned, in the time of Augustus, there were a separated category of capitals that caused confusion in regards of dating. These capitals, ranging between the 1st century BC and the 1st century AD, were basically a continuation of the Ptolemaic designs of the Alexandrian and Upper Egyptian Corinthian capitals. Only few of them are of certain date within the range of the 1st century AD, which I shall discuss below.³⁸⁸

Following Augustus, the evolution of the Corinthian capital takes three paths:

- i. The continuation of the production of the four Hellenistic designs of the Ptolemaic/Alexandrian Corinthian capitals.
- ii. A brief appearance of the eastern version of the canonical Augustan capitals in Hermopolis Magna.
- iii. The development of new three varieties of the Type I Alexandrian Corinthian capitals in the Roman period by the end of the 1st century AD until the 4th century AD.
- iv. The importation of the Asiatic Corinthian capitals from Aphrodisias, and their evolution in Alexandria, and the related types that emerged in Rome.
- v. The gradual change of capitals towards the proto-Byzantine designs.

The Continuation of usage of the Ptolemaic/Alexandrian Corinthian Capital Designs

Type I Alexandrian Corinthian Capitals

Starting from the late 1st century AD, the production of Ptolemaic versions of the Corinthian capitals had reduced. However, their production resumed towards the 4th century AD. The production and importation of both the Augustan and Asiatic types of Corinthian capitals did not fully affect the Hellenistic spirit as in Athens or Asia Minor.

Although Type I Alexandrian capital production, the most popular of all types, did not wither, we can see how designs from Alexandria and Upper Egypt co-existed, producing three new sub-types of the Type I Corinthian. Two of the designs used for the first subcategory of the Free Type I Alexandrian Corinthian capitals were abandoned. We can see how only the Type I capitals with concave central helices without cauliculi had survived. This type from the first subcategory had undergone a change from its Alexandrian form into the Dandarian form – see Figure 60, the Ptolemaic capital from the Nymphaeum of Dandara and its continuation under Augustus. Only a few capitals survived from Alexandria. The rest of the examples appear from Upper Egypt, which is traced back to the Ptolemaic Egypt and how they originally emerged in Dandara, at the Fountain House that follows the Temple of Hathor.³⁸⁹

According to McKenzie, these types of capitals are divided into three designs. These designs emerged in the 2nd and 3rd centuries AD. However, according to the records by Pensabene, these types existed since the Ptolemaic period and their production resumed towards the 4th century AD.

The first design (Figure 245) is applied on capitals from Alexandria (Figure 246), Dandara (Figure 247) and Edfu (Figure 248). They characterized by their simplified, large helices with a prominent convex outline, a central fleuron with two lesser fleurons on thin stems; all emerging from the main central, thick stem. Their acanthi

³⁸⁷ Tkaczow 2008: 23, 24, 35; footnote no. 63. Also see cat. no. 87-131.

³⁸⁸ McKenzie 2007: 221.

³⁸⁹ McKenzie 2007: 223, 225.

leaves are not of the standard design, but rather a variety of vegetal leaves.³⁹⁰ In my opinion, they resemble wide tree leaves.



Figures 245. (left) A sketching of the Type I.A Free Corinthian capitals (McKenzie)

Figures 246-8. (middle left - right) Type I.A Free Corinthian capitals from Alexandria, Dandara, and Edfu (McKenzie)

Originally, this design is traceable back to, and its appearance was centered on, the Temple of Hathor in Dandara, both the Nymphaeum and the procession road from the Nymphaeum towards the temple. This design appeared in the 2nd century BC. By the 1st century AD, probably starting under the post-Augustan emperors, these types of capitals started to emerge, replacing the Ptolemaic version of the Type I Alexandrian Corinthian capital – see Figure 60.³⁹¹

The second design (Figure 249) is found at Hermopolis Magna (Figure 250) and from Alexandria (Figure 251). They are characterized with their flat, shallow, plain, prominent helices, but without an outline. The helices are extremely wide by the base and extremely narrow near the coiling endings. The acanthus leaves of the upper collar are folded, with curved triangular endings, long and narrow; a close resemblance to the Italo-Hellenistic Corinthian capitals.³⁹²



Figure 249. (left) A sketching of the Type I.B Free Corinthian capitals (McKenzie)

Figures 250-1. (middle- right) Type I.B Free Corinthian capitals from Hermopolis Magna and Alexandria (McKenzie)

The third design (Figure 252), probably from the 4th century AD, is found at Luxor (Figure 253) and Alexandria (Figure 254). This type was presented by Pensabene as two separate categories under the label of the Normal/Canonical Corinthian capitals. The only difference between them is that one type is presented with calyces, while the other is known for total omission of the helices. Both designs are not presented with

³⁹⁰ Pensabene 1993: 112, 117, 118; McKenzie 2007: 225.

³⁹¹ Pensabene 1993: 362, 363; cat. no. 221–226;

By observing both the design as well as the dimensions of all the capitals at Dandara, we can see how all capitals, both Ptolemaic and Roman, follow the same schematic design, and also the same dimensions, where the total height is 68cm, the height of the lower block is 28cm and that of the upper block is 29cm. The designs had slightly additional motifs, but the dimensions of the capitals are all perfectly the same.

³⁹² Pensabene 1993: 112, 117, 118; McKenzie 2007: 225.

cauliculi. The latter is extremely simplified. Only one example (Figure 224) falls to this category, but rather is decorated with a very simplified version of calyces.³⁹³



Figure 252. (left) A sketching of the Type I.C Free Corinthian capitals (McKenzie)

Figure 253-4. (middle- right) Type I.C Free Corinthian capitals from Luxor and Alexandria (McKenzie)

Based on the descriptions provided by both Pensabene and McKenzie, we can analyze the capitals motifs as follow:

- The capitals are either of one block as in Alexandria and Luxor (Figures 246, 250, 251, 253) or of two blocks as in Dandara (Figure 247).
- Central helices are presented slightly separated from lower lip of the abacus, parted from it by two thin stems that emerge from the central fleuron's stem (Figures 246, 247, 250, 251).
- The helices emerge directly from the acanthus collar (Figures 246, 247, 251, 253).
- The design of the helices is either an empty area surrounded with two prominent, convex lines for an outline, where they are extremely wide by the base and extremely narrow by the top (Figures 246, 247), or the entire helices are simplified and prominent without a convex outline, where the helices are wide at their base by the acanthus collar and narrow by the coiling endings (Figure 251), or standard but reduced, convex Ptolemaic-like helices (Figure 253).
- The fleuron is placed directly on the abacus.
- The stem of the fleuron is visible, presented either in a straight line (Figures 250, 251) or partially curved (Figure 246), but always thick, or replaced with two X-shaped stems within the area of the helices, ending with two lesser fleurons emerging from behind the helices (Figures 247), or completely removed (Figures 253, 254)
- Corner volutes are of double water plants.
- The acanthus collar leaves are presented with all its leaves on the same elevation or close to the same elevation. All leaves are extremely curved.

Type III Alexandrian Corinthian Capitals

In regards of Type III, there is not much to be mentioned. Unfortunately, we have two examples only, one from Dandara (Figure 255) and the other from Philae (Figure 256).³⁹⁴ The Dandara capital is identical to the Ptolemaic design, with interlocking helices. The note worth mentioning is that the acanthi of the collar are replaced with vine leaves; already a known Ptolemaic practice. The capital from Philae is partially Ptolemaic. Its volutes are doubled, thick, and fluted. The helices are partially reduced and thin. That distinguishes this capital from its Ptolemaic counterpart is the central, triangular motif that separates its central helices, driving them apart.³⁹⁵

³⁹³ Pensabene 1993: 110; McKenzie 2007: 223, 225.

³⁹⁴ Its origin as either an Augustan or Post-Augustan capital is uncertain. However, it certainly belongs to the 1st century AD.

³⁹⁵ McKenzie 2007: 221, 222.



Figure 255-6. (left– right) Type III Alexandrian Corinthian capitals from Dandara and Philae (McKenzie)

The Alexandrian Designs of the Asiatic Corinthian Capital

In regards of the appearance of the Asiatic Corinthian capitals in Alexandria, it is very close to its Roman counterparts. Since being originally a late 1st century AD invention, these capitals were imported partially or fully carved from Asia Minor. The introduction of these capitals was presented by the artists who came from Asia Minor, who trained the local artists into the Asiatic art. Unfortunately, most of these types of capitals are separate cases, with no indication to their original buildings, except for few capitals from Kom El-Dekka, which will be discussed later in this section. These types of capitals, centered around the usage of the marble, mainly imported, from the Island of Proconnesus until the foundation of Constantinople by the late 3rd century AD or the early 4th century AD.³⁹⁶ These capitals will be later replaced by other Asia-Minor-imported marble capitals; however later on, these capitals will be a production of Constantinople, which will be introduced as Byzantine capital – see Chapter III.

As the case in Rome, the Asiatic Corinthian capitals appearing in Alexandria were divided into several types and groups. Pensabene had divided them into six groups, subdivided into 18 types.³⁹⁷ Examples at hand are from Alexandria and reused capitals in Cairo. However, I will be excluding the capitals from Hermopolis Magna and present them later.

Instead of studying each subgroup individually and regrouping them, I shall divide them as follows, where each group of capitals with a certain motif is to be presented together, in contrast to any changes in the motif throughout the following centuries. This classification was already presented by Pensabene in his research, which I decided to simplify it:

Capital Analysis and Comparisons

According to Pensabene, one example from each Asiatic capital subgroups will be presented and track down its origin and source of influence. These capitals have mirror-like reflections, dated to previous periods, especially from Hadrian's reign. By analyzing these capitals³⁹⁸, we can conclude which area had produced this specific specimen and the monument that reflects each type, if possible.

Figure 257: This capital is dated to the second 30 years of the 2nd century AD. Only three thorny leaves remain visible, with three sinuses each. The background of the upper row has a smooth surface. The cauliculi have convex edges. Both volutes and helices emerge from the cauliculi, ending with large coiled endings. The capital has resemblance to the Asiatic type from Pergamon – see the Temple of Deified Trajan (Figure 219) for comparison.



Figure 257. (top to bottom) Asiatic Corinthian capitals, Alexandria (Pensabene)

³⁹⁶ Pensabene 1993: 153, 167, 168.

³⁹⁷ Pensabene 1993: 153–156.

³⁹⁸ Pensabene 1993: 393, 397, 399, 401, 402, 404–7, 440; cat. no. 379, 394, 400, 410, 412, 421, 427, 430, 436, 438.

Figure 258: This capital is dated to the Severan period; late 2nd century AD to middle 3rd century AD. A double thorny leaves collar with separated leaves; where the leaves of the upper collar have their midribs fading by the middle of the lower collar's leaves. The upper collar leaves had five sinuses while the lower have four. Leaves of the upper collar extend by their low-most leaves, extending and intersecting above the center of the lower leaves of the lower collar – horizontally elongated. See Athens (Figure 214) and Lepcis Magna (Figures 237A-B) for comparisons.



Figure 259: This capital is dated between the end of the 2nd century AD and 3rd century AD; unearthed at the site of Cinema Amir. A double thorny acanthus collar with four deeply carved ribs; two side-ribs and two midribs; the upper collar has its midribs fade by the upper leaf of the lower collar. The helices are thin, reduced, with no stems and convex. Acanthized calyces emerge directly from the collar with no cauliculi. The fleuron is daisy-like. Similar examples are found in Ephesus – see the Celsus Library (Figure 221) and the Gate of Hadrian (Figure 222).



Figure 260: This capital is dated to the first half of the 3rd century AD; unearthed in Kom El-Shoqaffah. It is similar to Figure 405 in regards of the acanthus collar. The helices are shortened. The internal calyx leaves are extended, intersecting with the central leaf of the upper collar. The capital resembles the type of Asiatic capitals from the city of Tyre – see Figures 234-235.



Figure 261: This capital is dated to c. middle of the 3rd century AD; unearthed in El-Masallah district. A double thorny acanthus collar with separated leaves; the upper collar has four leaflet endings, while the lower collar has three. The calyces are fleshy and wide, with almost no traces for the cauliculi; the latter loses its function by this period. The helices flat, embedded within the stems of the volutes, where they are reduced and have their own stems omitted. The central fleuron is missing, and its stem is not represented. This design is traceable back to Asia Minor, to the second half of the 2nd century AD and throughout the 3rd century AD. Also, capitals of similar designs were used at the Palace of Diocletian in Spalato (Figure 213).



Figure 262: This capital is dated to the 3rd century AD; unearthed in Moharam Bey. The capital is decorated with a double collar of thorny acanthi, with developed, narrow and elongated sinuses. The leaves of the lower collar are touching, while those of the upper collar are slightly separated; close resemblance with Figure 268. Cauliculi are reduced, with flat-edged leaves. The volutes are slightly reduced and crushed between the outer calyx leaves and the lower lip of the abacus. The two sides of the capital presented are decorated with an eagle-like motif, on one side, and lyri-form helices, extending from the calyces upwards, on the other side, replacing the fleuron.



Figure 263: This capital is dated between the 3rd century AD and early 4th century AD; unearthed at the side of the Auditorium of Kom El-Dekka. A double thorny acanthus collar with separated leaves; the midrib of the upper collar leaves extend towards the base of the capital. Acanthized calyces support the volutes and helices. The helices are reduced, yet their stem is still visible. The capital, although of a later period, it follows the early canonical Augustan style – see Figure 161.

Figures 258-63. (top to bottom) Asiatic Corinthian capitals, Alexandria (Pensabene)

Figure 264: This capital is dated to between the second half of the 3rd century AD and early 4th century AD; Kom El-Shoqaffah Necropolis. It resembles Figures 262. However, it differs at having acanthi with three leaflets instead of four. The lobes of the upper collar are reduced. Helices are presented in a ribbon form, emerging to and intersecting over the abacus, forming a reduced calyx-like motif. Volute are thickened and crushed between the calyces and the lower lip of the abacus. Inner calyx leaves are very thin and reduced.



Figure 265: This capital is dated to the first two decades of the 4th century AD; provenance unknown. The capital is close to Figure 259. Leaflet endings of the upper collar intersect, while the lower collar has only the upper leaflets intersect; both collar form geometric figures. Cauliculi are barely visible. The inner calyx leaves intersect with the central acanthus leaf from the upper collar. The volutes have elongated stems, but semi-reduced coiling endings.



Figure 266: This capital is dated to the 4th century AD; provenance unknown. The lower acanthus collar intersect at two out of four leaflet endings, forming geometric figures at the bottom part; triangular shapes. The sinuses formed are deep, oblique shapes, with intersection of the upmost leaflet with the low-most leaflet of the leaf below. The helices are reduced, with short stems, in contrast to the volutes with their long stems. Both volutes and helices emerge directly from the acanthus collar, with omission to both cauliculi and calyces - probably adapted from the Ptolemaic capitals. It also resemblances Figure 265.



Figure 267: This capital is dated between the late 3rd century AD and the early decades of the 4th century AD. The lower collar of acanthi leaves interest, forming geometric figures. The background shadow is arch-like. The calyces have smooth leaves. Acanthi have almond-like sinuses. Helices have short stems in contrast to the volutes. Only the upper rim of the cauliculi is barely visible. Capital resembles Figure 265.



Figures 268 and 269: Both capitals are dated to c. early 4th century AD. Both capitals have acanthi of the lower collar intersect, forming geometric figures. However, the upper collar leaves and the calyces from Figure 268 have swollen leaves. There is almost no trace of the cauliculi in Figure 268, but only the upper rim is visible in Figure 269. The helices are reduced, in contrast to the fully developed volutes.

Figures 264-7. (top to bottom) Asiatic Corinthian capitals, Alexandria (Pensabene)



Figures 268-9. (left - right) Asiatic Corinthian capitals, Alexandria (Pensabene)

Figure 270: This capital is dated to the first half of the 4th century AD. The acanthus leaves take a unique shape with large leaflets, but in a lesser number of leaflets each. Helices are reduced, while the volutes have long stems with reduced coiling endings. Both are thin, and crushed between the calyces and the abacus. Calyces have their inner leaves thin and reduced, intersecting with the central leaf of the upper collar. Capitals with similar acanthi motifs will appear in the Byzantine period, as a production of the monastic district of St. Mina – see Chapter III.

Figure 271: This capital is dated between the second and third twenty years of the 4th century AD; unearth in Moharam Bey District. The capital has double acanthus collar with adjacent leaves, together forming geometric figures. The upper collar leaves form triangular motifs with their low-most leaves, and elongated sinuses with their upmost leaflets within the leaf itself. Helices are coiled and partially reduced, with wide coiled endings. Cauliculi are reduced, where their leaves form geometric motifs at the center. This model will appear later in Constantinople; proto-Byzantine.

Figure 272: This capital is dated to the third quarter of the 4th century AD; unearthed in Moharam Bey District. The leaves are reduced in number of lesser leaves. Both the cauliculi and calyces are missing. The volutes are flattened, rising directly from the space between the leaves of the upper collar. Helices are reduced.

Figure 273: This capital is dated between the second half of the 4th century AD and early 5th century AD; provenance unknown. A double lower collar of eight leaves intersects with geometric figures at a wide scale. The upper collar leaves intersect at the low-most leaf. A central acanthus leaf replaces the fleuron's stem. The calyces are omitted, where the volutes and helices take the shape of the calyx. The volutes have large coiled endings, while the helices are reduced. The whole motifs of the capital are shallowly carved.

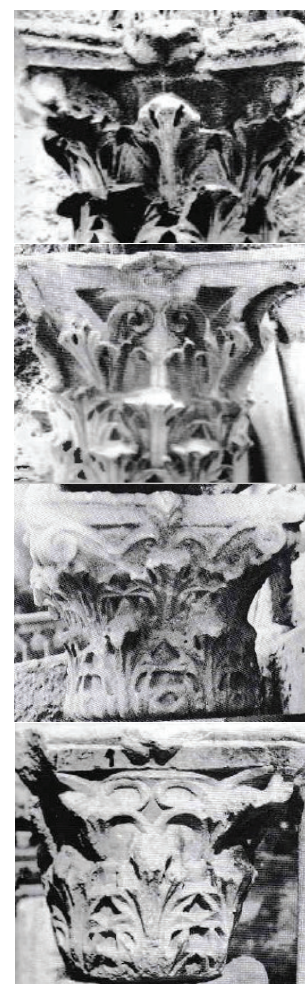

Figures 270-273. (top to bottom) Asiatic Corinthian capitals, Alexandria (Pensabene)

Motif Analysis

According to previous examples and divisions, we can conclude the following:

- Double collars with thorny acanthus leaves; a motif applied to all capitals of the marble Asiatic Corinthian capitals with no exceptions – in regards of examples at hand.
- Acanthi leaves are separated in earlier capitals (Figures 258, 259, 261, 263), except for Figure 257, which acts as an intermediate transition motif design between separated and touching leaves, with semi-touching or very close leaflet endings. Later capitals form geometric patterns at the intersection points of the leaflet endings (Figures 260, 265–273).
- The lower acanthus collars with separated leaves can be divided into groups, of which the stems of the midribs of the upper collar extend down towards the base of the capital (Figures 257, 263), while other capitals (Figures 258, 259, 271) have their midribs fading before they reach the same elevation with the half of the lower collar's leaves.
- The lower acanthus collars with leaves forming geometric patterns have the midribs of the upper collar fading by the topmost leaflets intersection, directly above the topmost geometric pattern (Figures 265–9).
- The lower acanthus collar leaves have five sinuses, while the upper collar has three (Figures 257, 258, 263, 265). A process of reduction appears by the half of the 3rd century AD (Figure 258) into one or two leaves. This led to the simplification towards the upper collar by the end of the 3rd and beginning of the 4th century AD (Figures 265–269).
- Each leaflet is divided into three and four leaflet endings.

- Caliculi remain an important part of the capital throughout the second century until the Severan period, where they fall into the stage of oblivion. Only the upper rim can be seen attached to the bottom of the calyces (Figures 258–262, 265–269, 272, 273).
- The calyces remain of the traditional design; two acanthized leaves supporting both the volutes and helices from below by their coiling endings. However, the internal leaves underneath the central helices are reduced. In most cases, the inner calyces leaves touch the central acanthus leaf of the upper collar.
- Both the volutes and helices undergo the same reduction process, where the central helices are reduced to the extent of losing their stem (Figures 259–261). Some capitals have their helices tongue-shaped (Figure 264).
- Both the volutes and helices lose their function as supporters of the abacus. Also, caliculi loses its function and becomes almost invisible, save for few examples with the rim visible or partially visible.
- The abacus is presented in a thinner form, molded, and divided into two parts.
- The central fleuron is presented as a leafy flower. The central fleuron is sometimes presented in a small lyriform (Figures 259, 261, 263), or as a small acanthus leaf (Figure 259), or replaced by the volutes or eagle-shaped motif (Figure 262) or volutes in the shape of a calyx holding the fleuron (Figure 264)
- The fleuron's stem is presented as a wavy stem, emerging directly from behind the central leaf of the upper collar. However, in other cases (Figures 259, 260, 261, 263, 265, 267, 268, 269, 272), the stem either not visible or omitted. This is due to the exaggeration of the usage of acanthi motifs for the calyces and upper collar.

Buildings and Monuments with Corinthian Capitals in Alexandria

Sarapeion (the Roman Phase) and the Column of Diocletian

According to Pensabene, and based on the theories presented by Susan Handler about the three representations of the façade of the Sarapeion on Roman coins, it appears that until the end of the 2nd century AD, the original Hellenistic Sarapeion was still standing. Although Botti had theorized how the Sarapeion was rebuilt under Hadrian, Handler's theory rejects that of Botti, assuming that its reconstruction was done first under Hadrian in AD 117–138 and later under Caracalla.³⁹⁹

According to Handler, Type I and Type III coins represent the façade of the Sarapeion in Corinthian order. In Type I, especially the coins from the fifteenth year of the reign of Trajan show the tetrastyle façade with Corinthian capitals (Figure 274), or distyle decorated with "curled volutes above a ring of three leaves" (Figure 275). Type III coins, dated to the reigns of Hadrian, Pius and Aurelius (Figure 276); represent the Sarapeion in a distyle rather than a tetrastyle, decorated with Corinthian capitals. The capitals have "two down-curving volutes over three dots."⁴⁰⁰ Moreover, the description by Rowe, presented by McKenzie, shows that the façade of the Roman Sarapeion was decorated with six or eight Corinthian columns.⁴⁰¹



Figures 274-276. Roman Coins from Alexandria with the representation of the Roman Sarapeion (Handler)

³⁹⁹ Pensabene 1993: 198, 199; Handler 1971: 68.

⁴⁰⁰ Handler 1971: 65.

⁴⁰¹ McKenzie, Gibson and Reyes 2004: 92.

However, there is certainty about the enlargement and expansion of the Sarapeion in the Roman period. Since the temple was on fire in the reign of Commodus, we can ensure a reconstruction at a certain point, expanding from the reign of Trajan, due to the Jewish revolt in AD 114–115, until the Severans in AD 211, and probably also under Caracalla in AD 215.⁴⁰² It is assumable that the reconstruction period of the Sarapeion was between AD 181 and AD 215–216.⁴⁰³



Figures 277. A fragment of an acanthus leaf of an Asiatic Corinthian capital from the Sarapeion (McKenzie)

Figure 277: A fragment of a Corinthian capital dated to the late 2nd century or the early 3rd century AD. The fragment is from the acanthus collar, representing a thorny acanthus leaf. This indicates that the capital is from the Asiatic type of Corinthian capitals. It also resembles the Asiatic type of capitals found at the site of the Basilica at Hermopolis Magna – see p. 127-9.

Another great monument at the site of the Sarapeion at the center of its portico is the Column of Diocletian, commonly known as Pompey's Pillar. The column was dedicated to Emperor Diocletian in AD 298, after the great revolt in Alexandria. The column is the only still-standing monument from the Roman period of Alexandria.⁴⁰⁴

Figure 278: The capital of the Column of Diocletian is a two-block capital, with a tall kalathos, wrapped with a double acanthus collar. The leaves of the acanthus collar are flat and smooth, with their tips slightly bent. The leaves of the upper collar are corn-shaped. From the first collar and the space between the leaves of the upper collar emerge the cauliculi. From the cauliculi grow the calyces in a very elongated and horizontal form. The volutes and the external calyces' leaves are of the normal size, while the helices and the interior leaves of the calyces are small.⁴⁰⁵



Figures 278. The capital of the Column of Diocletian (McKenzie)

By observing the capital, we can notice how the capital has narrow edges, where it loses the Vitruvian relation between the circumference of the kalathos and its base. The surface of the kalathos is noticed as smooth and flattened. The capital in general is a reference to the canonical imperial Corinthian capitals; a characteristic of the Tetrarchy/Constantinian period of reusing capitals of a more Augustan nature rather than the Asiatic types.⁴⁰⁶

The Roman Baths, Kom El-Dekka

Based on the studies by W. Kolataj and Pensabene, a series of Corinthian capitals belonging to different periods were used and reused at the Baths. Regarding the imperial period until the 4th century AD, Asiatic types of Corinthian capitals were used at the capitals of the portico of the frigidarium. The capitals in general follow the same design used for the Severan Basilica at Lepcis Magna – see (Figures 237A–239).⁴⁰⁷

Figures 279–281: A set of capitals from the second half of the 3rd century AD; the leaves of the lower collar are separated, with a semi-oval outline. Sinuses are presented in an almond-like shape. The leaves of the upper collar are carved deeper than those of the lower one. The cauliculi are barely visible, except for their upper rims, where the calyces emerge. The latter have thin and reduced inner leaves, intersecting at the upmost leaflet of the upper collar's central acanthus leaf. The helices are extremely reduced and ribbon-like, with almost no visible stem; in contrast to the fully developed volutes. The volutes are crushed between the lower

⁴⁰² Handler 1971: 64, 65.

⁴⁰³ McKenzie 2007: 196.

⁴⁰⁴ Pensabene 1993: 200; McKenzie 2007: 209.

⁴⁰⁵ See for more analysis: Pensabene 1993: 323; cat. no. 39.

⁴⁰⁶ Pensabene 1993: 323.

⁴⁰⁷ Kolataj 1992: 167, 168.

lip of the abacus and the external calyces' leaves. The abacus of Figure 281 is presented thicker than the rest of the standard Asiatic types.⁴⁰⁸



Figures 279-281. Corinthian capitals from the Roman Baths at Kom El-Dikka (Kolataj)

Catacombs of Kom El-Shuqaffa and the Corinthianized Egyptian Capitals

Dating to the end of the 1st century or the beginning of the 2nd century AD, the catacombs are among the very few that remain in Alexandria. Although of the Roman period, the façade of the central underground chapel reflects a unique style of mixing both the Corinthian and the Ancient Egyptian types (in papyriform) of capitals. This practice was common in Ptolemaic Egypt – see above in Chapter I, but probably rare in the Roman period. However, we can see how the façade of the inner chapel was a successful imitation of this practice, described as "Composite foliate capitals."⁴⁰⁹

The capitals resemble the Types I and II Corinthianized Egyptian capitals from Ptolemaic Alexandria – see Figures 34 and 40. The acanthus collar was replaced with a double collar of papyri. However, the helices are of the Type III Alexandrian Corinthian capitals; one of the few non-canonical/Type I capital motifs that remained throughout the Roman period – see Figure 282.⁴¹⁰

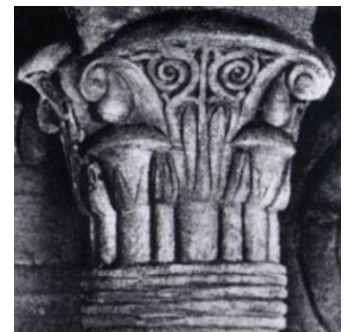

Figure 282. A Corinthianized Egyptian with Type III helices from Kom El-Shuqaffa (McKenzie)

The Asiatic Corinthian Capitals from Hermopolis Magna

The city of Hermopolis under the Romans differed from its previous phase under the Ptolemies. Instead of a city centered on a sanctuary, Hermopolis expanded majestically under the Romans in regards of architecture. The Dromos of Hermes and the Antonine Street mark the main north-south road of the city, cutting through the city, where the most important Corinthian-decorated monuments lie. By the first half of the 2nd century AD, the Asiatic type of the Corinthian capitals was introduced in Hermopolis Magna as the canonical Roman type of the Corinthian capitals, with relation to the Temple of Deified Trajan in Pergamon – see Figure 219.

In discussion of the type of the Asiatic Corinthian capitals from Hermopolis Magna, it was intentional to separate them from the rest of capitals found in Alexandria and its nearby sites. Pensabene had labeled them in his book separately, where capitals from the site are of limestone, not imported marble, and have three common features of separate acanthi leaves, thin cauliculi, and calyces' leaves with thick or swollen rims.⁴¹¹

⁴⁰⁸ Pensabene 1993: 400; cat. no. 402–404.

⁴⁰⁹ Pensabene 1993: 155, 394–397; cat. no. 381–393; Empereur 1998: 156; McKenzie 2007:193, 194.

⁴¹⁰ McKenzie 2007: 194.

⁴¹¹ Pensabene 1993: 154, 394.

The focal point of Hermopolis Magna is the area intersecting the Dromos of Hermes with the Antonine Street. Several important monuments were erected there throughout the imperial period; the Komasterion, the Sphinx Gate and its temple, the Great Tetrastylon, and the Nymphaeion (Figure 283).

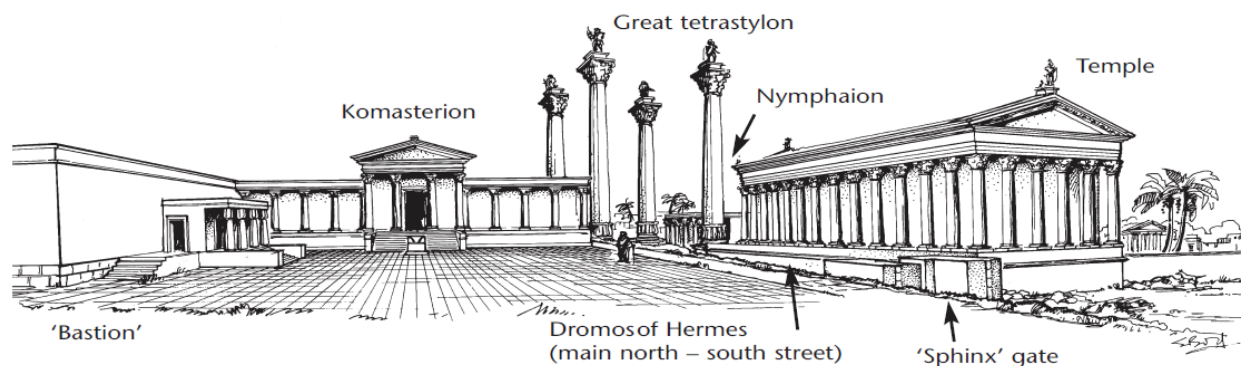

Figure 283. A reconstruction of the Corinthian monuments by the NS main road at Hermopolis Magna (Bird)

The Komasterion (Figure 283), by and connected to the Antonine Street, was a Roman procession house. The Komasterion is dated to the Antonine Period, c. middle of the 2nd century AD, and it survived until the 5th century AD. The capitals from the Komasterion were dated to the middle of the 2nd century AD, carved using local limestone with Antonine period designs.⁴¹²

Figures 284A-B: Both capitals are decorated with thorny acanthi, where the leaves of the lower collar are of normal size. However, those of the first capital have their upper collar's leaves elongated. The cauliculi of the first capital are presented narrow, elongated, while those of the second are of the normal design; both have swollen rims. Both volutes and helices of the first capital are reduced, in addition to the extreme reduction of the helices and the invisibility of their stems. Those of the second capital have only reduced helices, while the volutes are developed. The stem of the fleuron is wavy, emerging from the acanthus collar and passing between the helices. Both capitals have similarities to Figure 263 from the Auditorium of Kom El-Dekka; however with thinner leaves. There is also resemblance to the capitals from the Trajanium in Pergamum and the Hadrianic library in Athens – see Figure 214.⁴¹³

The Great Tetrastylon (Figure 283) was, like and Unlike the Quad-arch of Lepcis Magna, decorating the crossroads between the Dromos of Hermes and the Antonine Street. It was a set of four honorific (tetrastylon) columns, crowned with Corinthian capitals and over them stood four statues of Roman emperors; not a quad-arch like the Severan Tetrastylon of Lepcis Magna. The Tetrastylon was probably reconstructed in the Antonine period, as mentioned in the describing papyri. It mentioned that the capitals presented in the Antonine period differed from the ones found by the Dromos of Hermes.⁴¹⁴

Figure 285: A reused capital from the Basilica, but originally is one of the capitals of the Great Tetrastylon; dated to the late Antonine period. The capital is decorated with a double acanthi collar, where the leaves of the lower collar are extremely close by the lower leaflets, forming geometric figures. The sinuses are almond-

⁴¹² Bagnall and Rathbone (eds.) 2004: 164; Bailey 2012: 281, 282; Pensabene 1993: 247, 252, 392–395.

⁴¹³ Pensabene 1993: p. 394, 395; cat. no. 381, 382;

Also see cat. no. 383 and 384 from the same catalogue by Pensabene for an identical capital to cat. no. 382, but with deeper shadowed background, thicker helices, and a more flattened capital surface, presenting the capital in a more square rather than cylindrical manner; probably a capital of a semi-column against the walls of the Komasteion, not a free-standing column from the façade. Cat. no 392 from the same category comes at the later decades of the 2nd century AD, but still executed in the same manner of the previous capitals from the middle of the 2nd century AD.

⁴¹⁴ Pensabene 1993: 247; Bagnall and Rathbone (eds.) 2004: 164; McKenzie 2007: 160; Bailey 2012: 283.

shaped with deep shadows. The cauliculi are presented in a conical shape. The capital follows the same typology of the two capitals from the Komasteion, especially Figure 284 in regards of the acanthi motifs.⁴¹⁵



Figures 284A, 284B and 285. Corinthian capitals from the NS main road; Komasteion and Tetrastylon (Pensabene)

The Sphinx Gate (Figure 283) of the temple was a two 2nd century AD construction by the crossing of the Dromos of Hermes and the Antonine Street. The Sphinx gate, although originally a thirtieth-Dynasty monument, it was rebuilt in the Roman period in hexastyle. It served as the monumental gate for the city's Capitolium. The gate was executed using the Corinthian order and limestone for the capitals; a local capital production rather than an imported Asiatic marble.⁴¹⁶

Therefore, we can conclude that "Tipo 4" presented by Pensabene can be considered as a subdivision or a copy from Figure 279 found at Kom El-Dekka, and its similar capitals. They share the separated acanthi motif and the lyriform or reduced helices. Along with the common motifs, the use of local limestone to reflect the Asiatic design reflects the continuation of the Alexandrian practice, even if it was abandoned in Alexandria itself.

As a result of analyzing the variations of the Corinthian capital designs in the Roman World – a period stretching from c. 3rd century AD until the beginning of the 4th century AD – we can conclude the following:

- The Italo-Corinthian capitals as an extension to the Greek culture and architecture in Southern Italy and Sicily. Also, the general design of the specimen followed the Epidauran capital, which in turn refers to the Type I Alexandrian Corinthian capitals as a probable replacing source.
- The adaptation and representation of Alexandrian architecture throughout the Pompeian Second Style Wall-Painting. It, confirms, first, the previous point about the influence of Alexandrian architecture – the Alexandrian Corinthian capitals – and, second, the adaptation of the Type IV Alexandrian Corinthian capitals in creating a new specimen, labeled as the Proto-Composite capitals – a theory originally discussed by Ronczewski.
- The Triumphal period of the 2nd century BC and how the victories of the Roman generals and the bringing of their *spoila* from the Eastern Mediterranean had transported the Hellenistic architecture of the fallen kingdoms into Rome. It also discusses and strengthens the theory about the adaptation of the Corinthian capital design from Samothrace as a prototype.
- Discussing the origin of the capital design of the Jupiter Capitolium and providing evidence by revisiting ancient sources and re-translating them properly. Also, a comparison between Sulla's sack of Athens and the first civil war in Rome, which the latter resulted in the burning of the Capitolium. The theory supports Catulla as the founder and in Doric rather than Corinthian for the second phase; a very-recent theory originally discussed by Christopher Siwicki in 2020.

⁴¹⁵ Pensabene 1993: 397; cat. no. 393.

⁴¹⁶ McKenzie 2007: 160; Bailey 2012: 281.

- The rise of Augustus and the canonization of the Corinthian capital on the bases presented by Vitruvius. The canonization varied between the eastern and western provinces, resulting in the appearance of several subcategories, mainly revolving around the adaptation of Hellenistic/Alexandrian capitals, as follows:
 - ▶ The adaptation of the Italo-Corinthian style in the north and north-east parts of the Italian Peninsula.
 - ▶ The appearance of a type of Floral capitals in the Iberian Peninsula, mostly based on the Nabataean versions of the Floral capitals adapted from the Alexandrian ones.
 - ▶ The continuation of the usage of the four Alexandrian types of Corinthian capitals in Alexandria and Egypt, leading to a period of confusion for archeologists; 1st century BC – 1st century AD capitals.
 - ▶ The adaptation of the Nabataean Blocked-Out capitals – originally were based on the Alexandrian ones – in Upper Egypt.
 - ▶ The canonization of the Corinthian capitals by Agrippa in the East, highly proposed to be modeled after the Samothracian capital.
- The appearance of three new types of capitals in Egypt centered on the Type I Alexandrian Corinthian capitals of the Hellenistic age.
- The rise of the Asiatic types of Corinthian capitals and their adaptation by Hadrian in Rome, and later their spread in Egypt and the rest of the provinces, replacing the canonical type.
- The gradual degradation in both imported and locally-produced Asiatic capitals, which paved way for the rise of Byzantine capitals – see Chapter III.

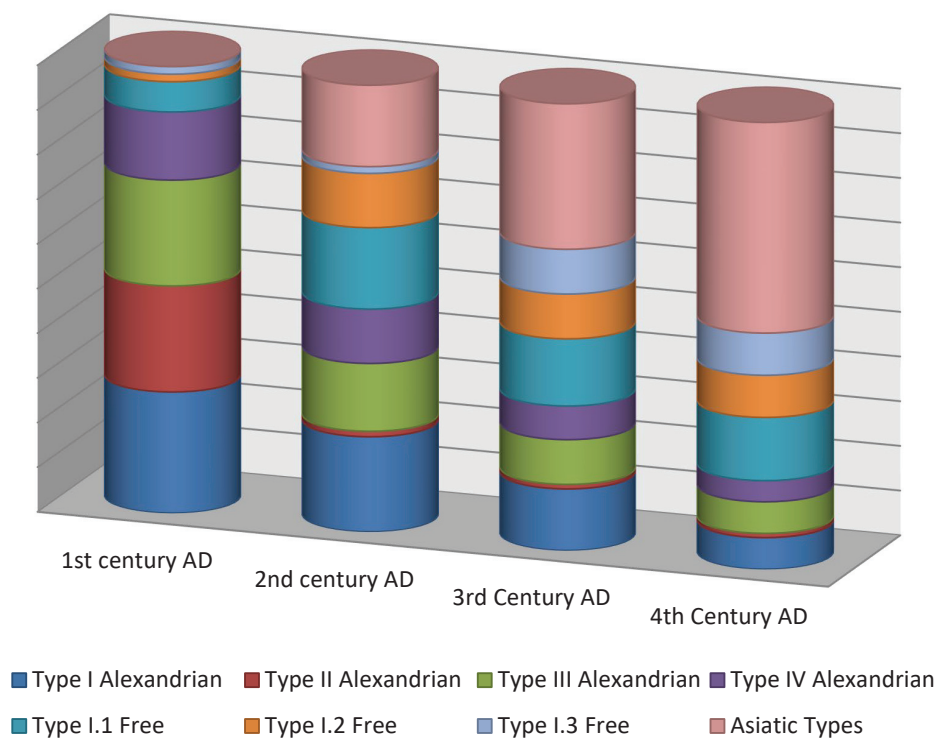

A chart showing the approximate usage of the four types of the Corinthian(-ized) capital in the Roman Period (1st century-4th century AD) in Alexandria and Egypt

Chapter III

Late Antique Corinthian Capitals from Alexandria and the Byzantine World

The period starting with the coronation of Constantine the Great in AD 330 until the Arab conquest of Egypt marks the Late Antique period of Egypt. This period swings between the two terms of Coptic and Byzantine; where the first is related to art and architecture, while the second is related to the imperial domination from the newly-built city of Constantinople; both politically and architecturally. However, in order to discuss both terms in relation to architecture, one must delve deep into historical, religious and general architectural contexts, which I shall try to refer to, briefly. The difference between both terms, architecturally speaking, would require a wider comparison that does not revolve only around Corinthian and Corinthian-related capitals. Therefore, I shall be using the English term of Late Antiquity more often than the French and German terms of Byzantine and Coptic, save for few exceptions that require further descriptions.⁴¹⁷ However, in order to give a very brief distinguishing element, based on the headlines by Pensabene, Byzantine capitals is a wide expression of using both local stones and imported marble, while Coptic capitals are of local stones only – described later in details.

This chapter revolves around three main ideas:

- i. The relation between the unearthed remains (capitals) of churches in Alexandria and their relation to the still-standing churches and their capital designs in the rest of Egypt, especially Upper Egypt.
- ii. The architectural relation between Alexandria and Egypt, on the one hand, and Constantinople and the rest of the Byzantine Empire territories, on the other hand.
- iii. The role of Alexandria as a source of influence rather than Constantinople.

McKenzie proposes that researchers had assumed that Alexandrian architecture had no influence over the rest of Egypt. The other point is that other researchers assume that the Egyptian versions of Corinthian capitals were based on the Constantinopolitan models, since the capital/imperial city had always been the source of influence; also an assumption built around the splitting of the Church of Alexandria from the Church of Constantinople, partially, after the Council of Chalcedon in AD 451 and, officially, in AD 558. Throughout written evidences and the level of mathematical supremacy and high educational level, McKenzie mentions that ecclesiastical architecture appeared in Egypt starting with the 4th century AD, while in Constantinople by the 6th century AD, in light of being referred to as Byzantine rather than Roman. Thus, McKenzie highlights how Alexandria had the upper hand in architecture influence, same as its dominance in the Ptolemaic period.⁴¹⁸ Therefore, in light of McKenzie's theory, I shall attempt to apply the same in regards of the evolution of the Late Antique Corinthian capitals from Alexandria as a source of influence over Constantinople.

As in the first chapter, Alexandria becomes once more a major architectural center for the Early Byzantine period. Architectural elements will be discussed via two stages:

- The architectural remains and reused capitals in Alexandria and Cairo – in regards of analysis, grouping, regrouping, labeling and categorization.
- The churches and monasteries of Egypt, and their relation to Alexandria.

⁴¹⁷ Pensabene 1993: 173; McKenzie 2007: 230, 231.

⁴¹⁸ McKenzie 2007: 231–233.

Therefore, I decided to discuss Alexandria and Egypt in the first section of this chapter, rather than starting with the rest of the empire, as in the previous chapter, since Alexandria acts as a primary architectural producer, and influencer to the rest of the empire. The question presented by McKenzie about the role of Alexandria in the development of Byzantine architecture and how it is reflected throughout the rest of Egypt's churches and monasteries will be the main guideline of this chapter.

Corinthian, Corinthianized, and Corinthian-related Capitals in Late Antique Alexandria and Egypt

Although Christianity was introduced in Alexandria by the middle of the 1st century AD by St Mark, it did not hold its ground until the last decades of the 3rd century or early decades of the 4th century AD. Several churches and buildings were erected in Alexandria. Unfortunately, none of them survived; save for the Auditorium of Kom El-Dekka. Several architectural capitals from Alexandria and the surrounding region were dismantled by the Arabs for the construction of mosques.⁴¹⁹

The history of church building goes back to the Church of Theonas which was built in AD 300–311; the first church established in Alexandria, in c. 351 at the site of the Sarapeion. Early Christian churches, like the ones from Rome, were constructed in the manner of a pagan temple. Under Patriarch Athanasius, about twelve churches were erected by 375 AD. The period between the 4th century AD and early 5th century AD was a period of great focus, where churches were constructed on a large scale. Most notably, the pagan sites, like those of the Sarapeion and Caesarium, were converted to or held churches within their premises. Finally, by the end of the 4th century AD, paganism was banned under Emperor Theodosius I, and it was marked in Alexandria by the burning of the Sarapeion in AD 391.⁴²⁰

Both ecclesiastic and monastic architecture had dominated several areas across Egypt. The most famous of them are the Basilica of Hermopolis Magna, the church within the Temple of Hathor in Dandara, the two churches of Bawit and Saqqara, Oxyrhynchus, and the White and Red Monasteries of Sohag. Interestingly, these buildings were highly influenced by Egyptian, Ptolemaic and Imperial Roman architecture – buildings adapting the Coptic art⁴²¹ (see cat. no. 132-218).

Church architecture tendency towards local and Alexandrian styles was more of commercial and transportation problems. It appears for some reason that by the 3rd and 4th centuries AD, marble importation from Asia Minor was difficult in regards of transportation to Upper Egypt. This forced local workshops to reuse local quarries of limestone and sandstone, and sometimes granite. These local workshops were still in practice of the local Alexandrian architectural styles.

It is assumable that the lacking of Asiatic crafted capitals as well as the presence of foreign artists created a time gap that allowed the local artists to revive the traditional and local styles, which was still somehow in practice; basically the Late Hellenistic traditions of the Alexandrian workshops.

However, the Asiatic style did not completely wither. Firstly, the importation of Proconnesian capitals from Asia Minor was not cut off directly. By the late 4th century AD, finished and semi-finished capitals were still imported; the latter was dominant and was finished within the Alexandrian workshops. These imported capitals had moved past the Imperial Asiatic designs and adapted the Byzantine ones. The design of these types of capitals was imitated by local artists, by also using local limestone.⁴²²

Although the capitals were produced in an Alexandrian manner, artists drifted from the Alexandrian norm, tilting the scale in favor of remaking the Asiatic types of capitals, which were known by that time as Byzantine or Constantinopolitan capitals. By the 4th century AD and most of the 5th century AD, acanthi were adorned

⁴¹⁹ McKenzie 2007: 231.

⁴²⁰ Pensabene 1993: 168; McKenzie 2007: 231, 240, 261.

⁴²¹ McKenzie 2007: 232, 233, 261.

⁴²² Pensabene 1993: 157.

with "midribs, long and narrow leaves, and with shorter and wider leaves."⁴²³ However, during the 5th century AD, thorny acanthi were officially replaced by shorter leaves with rounder and wider leaflet endings. By the end of the 5th century AD and the beginning of the 6th century AD, eyelet sinuses were more common, in relation to the disappearance of large dental-shaped ones.⁴²⁴

A point not mentioned by Pensabene is that certain types of Asiatic-based capitals imitated the capitals from Samothrace's Propylon and Rotunda – which are Ptolemaic, Hellenistic and Alexandrian in their essence – and other Ptolemaic/Alexandrian capitals. This will be discussed later in details; see p. 141ff.

The Historical Background and Categorization of Late Antique Corinthian and Corinthian-Related Capitals in Alexandria and Egypt

Asiatic-Based Corinthian Capitals

This type of capitals is the oldest to appear within the Late Antique period, generally, dated between the middle/end of the 4th century AD and, extending until the middle or, the second half of the 5th century AD, with very few examples of low probability being products of the early decades of the 6th century AD.

These capitals are dated according to their material. Limestone capitals are dated between early/middle of the 4th century AD and middle of the 5th century AD, while marble/imported capitals are dated between the second half of the 4th century AD and the 5th century AD.⁴²⁵ Based on the dating by McKenzie upon the excavation by Strzygowski, we can conclude that limestone or locally-produced capitals had adapted this style of capitals prior to its appearance in Constantinople and its crafting and exporting from Asia Minor.

These capitals were divided based either on the absence and presence of the calyces, or absence and rare presence of the helices, or the shapes and numbers of the acanthus leaves used per capital, or the shapes of the sinuses.⁴²⁶ This group of capitals is the closest to the Asiatic types; the standard type of capitals used in Constantinople.

The acanthi leaves are thorny, with elongated sinuses. Midribs and sideribs of the acanthi are visible. The upper collar acanthi are developed. Both cauliculi and calyces are presented. Generally, this group is almost identical to the Asiatic types; however, all their helices are removed. However, under Theodosius I, there was reduction in the calyces and cauliculi in favor of elongating the double acanthus collar to cover most of the kalathos. This type of capitals is divided as follows: The first category has all cauliculi, calyces and helices omitted. The acanthi are presented in a shallower form than previous examples, reduced into five-tooth leaves, elongated and the double collar is extended upwards to cover almost three quarters (3/4) of the kalathos. From the upper collar the corner volutes emerge directly. The second category has the acanthi presented in a dental form, with "eyelet" sinuses; the latter is divided into two subgroups.

Derived from the previous group is a more simplified group and of a better quality; reused in the decoration of the mosques of Cairo. This group is identical to the previous one; however, the elongation of the acanthus collars forced the omission of both the cauliculi and helices, presenting a type of capitals where the volutes

⁴²³ Pensabene 1993: 174, 175;

"rielaborazione del modello dell'acanto spinoso, sia a lunghe e strette foglietti, sia a fogliette meno lunghe e piu larghe."

⁴²⁴ Pensabene 1993: 174, 177.

⁴²⁵ See Pensabene 1993: 414; cat. no. 460; McKenzie 2007: 264

Pensabene suggested that these types of capitals appeared by the end of the 4th century AD; however, McKenzie proposed, based on a capital from Herakliopolis Magna (already the capital was discussed by Pensabene) that it goes back to the middle/beginning of the second half of the 4th century AD, c. 350– AD 425.

⁴²⁶ Pensabene 1993: 169.

emerge directly from the acanthus collar. This type of capitals was used in decorating the colonnaded streets of Alexandria; an Alexandrian product in its essence.⁴²⁷

It can be considered as a transactional bridge between the early Constantinian architectural and later Byzantine models, including their Coptic counterparts. It is the clearest type to show how the Asiatic types were gradually replaced with Constantinopolitan motifs; how certain motifs – mainly referring to the omission and/or rare usage of the cauliculi, calyces and helices. Also, as described by Pensabene, from the time of Constantine onwards, there was a general favoring regarding elongating and enlarging the leaves of the acanthus collar in favor of the upper motifs. This elongation resulted that the acanthus collar, instead of following the Vitruvian proportions of covering one third (1/3) of the kalathos, it extended to cover three quarters (3/4) of it. Therefore, we can find how the acanthus collar started extending vertically, squeezing the upper motifs between the abacus and the leaves of the upper acanthus row.

This vast category is basically the reflection and regrouping of the three types of Byzantine Corinthian capitals (Figures 286–302) presented by Pensabene. Based on Pensabene, had analyzed them as follows:⁴²⁸

Type I Asiatic-Based Corinthian capitals – volutes emerging from calyces

Capitals (Figures 286–290) dated between middle/late 4th century and the 5th century AD. Generally, they have double collar of thorny acanthi with flattened, enlarged leaves; volutes emerge from the opposite calyces leaves and omitted helices in most cases. The calyces have swollen external leaves and small, thin ones. However, they differ from the Asiatic types by being very reduced, rather than intersecting with the upper central acanthus leaf. Capitals vary in regards of the abacus' central motif design, ranging between a vegetal branch, a cross or a four-petal fleuron.

Capital exceptions lie with observing the following: figure 287 has the wreath circling the cross on the abacus with two lower ribbons that form a helices-like motif. Figure 290 is an exception regarding its inner calyx leaves, where they intersect with the acanthus collar, following the Asiatic design. Figures 288 and 289 have swollen acanthus leaves, clearly visible by the curving leaves of the upper collars.

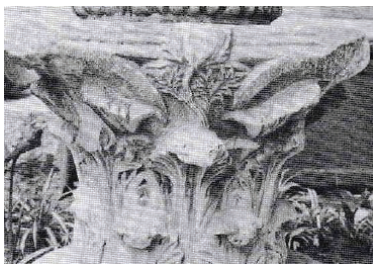

Figures 286 & 288. (left and right) Type I Asiatic-Based Corinthian capital, Graeco-Roman Museum, Alexandria (Pensabene)

Figures 287. (middle) Type I Asiatic-Based Corinthian capital, Coptic Museum, Cairo (Pensabene)

⁴²⁷ Pensabene 1993: 169, 170.

⁴²⁸ Pensabene 1993: 158–160, 162, 168 –172, 175; 411–416; cat. no. 451–568.



Figure 289. (left) *Type I Asiatic-Based Corinthian capital, Graeco-Roman Museum, Alexandria (Pensabene)*

Figure 290. (right) *Type I Asiatic-Based Corinthian capital, St. Mina (Pensabene)*

Type II Asiatic-Based Corinthian capitals – volutes emerging from calyces

Capitals (Figures 291–295) dated between the late 4th century and the early 6th century AD, where the majority of them are dated to the 5th century AD. Capitals are presented with flattened, thorny and/or enlarged leaves. The acanthus collar is presented in both singular and double forms, and the leaves are connected. Volutes emerge directly from the acanthus collar without any disorganized relation between the capital motifs. Helices and calyces are totally omitted. Also, all capitals have an arch-like motif in the background, connecting both volutes. The top of the acanthus leaves are swollen, where in some cases – i.e. Figure 293, the leaves of the upper collar are very smooth and form calyx-like motifs, where the volutes emerge. Also, the abacus motifs vary among ribbon-circled crosses, normal crosses and fleuron.⁴²⁹



Figures 291-2. (left and middle) *Type II Asiatic-Based Corinthian capitals, Graeco-Roman Museum, Alexandria (Pensabene)*

Figure 293. (right) *Type II Asiatic-Based Corinthian capital, St. Mina (Pensabene)*



Figure 294. (left) *Type II Asiatic-Based Corinthian capital, Graeco-Roman Museum, Alexandria (Pensabene)*

Figure 295. (right) *Type II Asiatic-Based Corinthian capital, St. Mina (Pensabene)*

Type III Asiatic-Based Corinthian Capitals – volutes emerging directly from the acanthus collar

Capitals (Figures 296–300) dated to the second half of the 5th century to the early decades of the 6th century AD. They are identical to Type II, where only differ in their design of acanthus leaves, being large and thorny

⁴²⁹ For more capital analysis, see: Pensabene 1993: 162, 416–421; cat. no. 469–488.

with very wide sinuses; a peculiar adaptation, since Type III Byzantine appears at a later date; however adapting the Asiatic type of acanthi. Capitals with omitted helices have their volutes elongated, sometimes bent, as in figure 297, which resemble a capital from the first phase of Hagia Sofia in Constantinople – see below Figure 377. Also, figures 298 and 299 have their helices presented.⁴³⁰

A subgroup of the same type of capitals (Figures 298, 300), dated to the 5th century AD, is considered a derivation of the Type III Asiatic-Based. It is unique for its dental-shaped, carved leaves with eyelet sinuses – see above figs 299–300. Also, the volutes of this group have its stems extremely carved downwards. This group did not favor the elongation of the acanthus collar, and also preserved the canonical Type I Alexandrian helices and the wavy fleuron's stem from the Imperial period. It also served as a model for both the disoriented types of volutes – which I will be discussing in the following point – and the V-shaped volutes, since the dislocation of the volutes from the center of the calyx shows the elongated stems of the volutes, of which, if the rest of the upper motifs were removed, could easily intersect at the middle of the kalathos like the **V-shaped volutes** from the Four-Corner-Acanthus capitals – see p. 137ff.

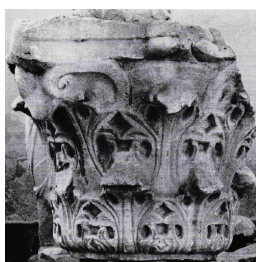

Figure 296. (left) Type III Asiatic-Based Corinthian capital, St. Mina (Pensabene)

Figure 297. (middle) Type III Asiatic-Based Corinthian capital, Graeco-Roman Museum, Alexandria (Pensabene)

Figure 298. (right) Type II Asiatic-Based Corinthian capital, reused at the Mosque of El-Nasser ibn Qalawon, Cairo (Pensabene)



Figures 299-300. (left and right) Type III Asiatic-Based Corinthian capital and lower fragment, St. Mina (Pensabene)

It is obvious that Constantinopolitan models would be based upon the Asiatic types. Also, omission of helices, for example, is a trait traceable back to the early Hellenistic models from Asia Minor. Thus, like the Coptic adaptation of Ancient Egyptian and Ptolemaic models, the Constantinopolitan models were subjugated to the same methods of evolution. Also, according to McKenzie's proposition of the predating of Alexandrian capitals to those from Constantinople, we can conclude that this gradual change throughout the Asiatic types of capitals appeared in Alexandria, then it was later adapted in Constantinople.

In Alexandria and Abo Mina, we find the two previously-mentioned categories are closely-related. The first (Type II) category has all cauliculi, calyces and helices omitted. The acanthi are presented in a shallower form than previous examples, reduced into five-tooth leaves, elongated and the double collar is extended upwards

⁴³⁰ For more capital analysis, see: Pensabene 1993: 171, 172, 421, 422; cat. no. 489–494.

to cover almost three quarters (3/4) of the kalathos. From the upper collar the corner volutes emerge directly. The second category (Type III) has acanthi presented in a dental form, with "eyelet" sinuses – see Figures 298, 300.

Capitals with disorganized proportions between the volutes and calyces

Regarding another locally-produced type of Asiatic-based capitals (Figures 301, 302), they were presented throughout several types by Pensabene, under different subgroups, with disorganized volutes and omitted helices; a Late Hellenistic feature. These capitals belong to the period between the late 4th century AD and early 5th century AD, then reappearing from the late 5th century AD until the early decades of the 6th century AD. They resembled the Asiatic-Based models, but rather with more thorny leaves, leaning more into being actual thorns rather than leaves, extreme reduction in the cauliculi and presenting developed but rather thin volutes. One capital is presented with thorny and short acanthi, while the other one has both straight and curved leaves. In figure 301, the leaves are thorny, but not as sharp as those of figure 302. Also, in figure 301, we can see how the helices imitate the Type III Alexandrian in emerging back-to-back, with their stems separated. They also replace the abacus fleuron.⁴³¹

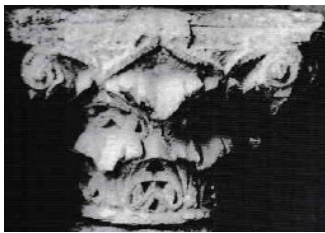

Figures 301-2. *Locally produced Asiatic-Based Corinthian capital and lower fragment, Graeco-Roman Museum/Louvre Museum (Pensabene)*

Four-Corner-Acanthus (Four-Leaf) Corinthian Capitals

This classification was originally provided by Pensabene;⁴³² however, I shall be focusing only on the main points of comparison and grouping in regards of their motifs. Pensabene had already divided them into Corinthian and Corinthianized categories; a method I try to avoid, since Corinthianized capitals have more differences in regards of their motifs – see p. 94ff, Corinthianized capitals within the Italian Peninsula. Therefore, I prefer to label the Corinthianized capitals as Reduced Corinthian capitals, since their motifs are indeed reduced and/or sometimes omitted. Also, I will be regrouping them differently. This grouping will help, by the next section, in grouping, categorizing and labeling these capitals in a more organized manner.

This category of reduced capitals appeared mainly in the 5th century AD, extending towards the early period of the 6th century AD. It revolves mostly around the designs of two main motifs. Firstly, there are always four leaves by the corners of the kalathos. Mainly, they are acanthi, but in few examples are replaced with water plant leaves. Secondly, the volutes, in case of representation, neither emerge from disorientated from a calyx nor directly from the acanthus leaves – save for two examples, regarding the latter. They are presented as V-shaped volutes in most cases. Thirdly, which was not mentioned, is that there is in most cases a diamond-shaped motif replacing the abacus' fleuron.

This category of capitals consists of four out of the five types of reduced capitals presented by Pensabene. Generally, they are divided into two subcategories based on the width of the capital. This category of capitals appeared through both Byzantine and Coptic architecture, where the latter is extremely reduced in regards of the design of the capitals.

⁴³¹ For more capital analysis, see Pensabene 1993: 176, 436, 443, 444; cat. no. 553, 580.

⁴³² Pensabene 1993: 158–160.

Pensabene had divided them into the following:⁴³³

Type I and Type II Reduced Corinthian capitals are dated to the 5th century AD. Capitals have four acanthus leaves by the corners and V-shaped volutes. Both groups have a frontal/central water plant leaf at each side of the capital. The only difference between both types is that in Type I, we have all capitals extremely reduced, where the acanthi cover the kalathos entirely; while in Type II, we see that the capitals are also reduced but not extremely reduced, giving space between the leaves themselves and another space between the leaves and the abacus.

Type III Reduced Corinthian capitals (have a wide span of dating, from the late 4th century AD until the 6th century AD, where most capitals loosely belong within 5th century AD. They are exactly like the previous two groups in regards of the corner acanthi and the V-shaped volutes. However, there is no frontal/central leaf on the faces of the capitals. Also, the corner acanthi themselves are sometimes replaced with water plant leaves. Basically, Type III Reduced Byzantine is itself a simplified or reduced version – regarding number of acanthi motifs – of the previous two types; a reduction of a reduction.

Type IV Reduced Corinthian capitals are a more simplified version of the previous type; a reduction of a reduction, like the relation between the reduced forms Types I and II to Type III – the relation between Type IV, and Types I and II is a reduction of a reduction of a reduction; triple removed. Certain group of capitals has extremely and barely visible V-shaped motifs, while another group has only the four corner acanthi.

Although all capitals are presented in an inverted trapezoid form, we can simplify them by naming them as wide-shaped and narrow-shaped capitals, which somehow resemble the rectangular and square geometric shapes respectively. The Coptic models are very close to the Narrow-Trapezoid capitals; however, they tend to take a more cylindrical form, rather than having curved edges. We can regroup them as follows:

Wide Trapezoid-Shaped Capitals

Wide-Trapezoid form of capitals is a regrouping of the Type I Reduced Byzantine Corinthian presented by Pensabene. Two exceptional capitals from Types III and IV follow the same wide form; however, these types fall under the narrow-trapezoid form of capitals.

- Wide-Trapezoid capitals with four acanthi at the four corners of the capitals and one central water-plant leaf at each face (Figure 303).
- Wide-Trapezoid capitals with four corner acanthi only from Types II and III of the Reduced Byzantine Capitals. The Type III capital is decorated with a Christogram/Chi-Rho symbol (ΧΡΙΣΤΟΣ) motif (Figure 304) or a tri-leaf fleuron (Figure 305).



Figures 303-5. Four-Leaf capitals in wide trapezoidal form, Graeco-Roman Museum, Alexandria (Pensabene)

Narrow Trapezoid-Shaped Capitals

The majority of the Reduced Corinthian capitals are presented within the narrow-trapezoid formation of capitals. So, we can say that the wide-trapezoid formation of capitals is a subcategory of the reduced capitals,

⁴³³ Pensabene 1993: 159, 171, 176, 185.

of which all the rest is presented here. This includes Type II of Reduced Byzantine capitals, which is almost identical to Type I of the same general category, in regards of the acanthi formation and volute design.

Also, V-shaped volutes do recall certain capital designs of the Type IV Alexandrian Corinthian capitals and the Proto-Composite capitals from South Italy, where there are also four supporting acanthus leaves by the corners of the capital. However, instead of having two coiling endings of each volute, they simply intersect by the center of the kalathos, either form with or without coiling endings – See Type IV Alexandrian Corinthian Capitals, p. 41ff, and Proto-Composite capital, p. 70ff, for comparisons. This is both an indirect and simplified/reduced version of the Ptolemaic version of these capitals. Based on the classification by Pensabene,⁴³⁴ we can analyze them as follows:

- Narrow-Trapezoid capitals presented with corner volutes at the four corner acanthi and a central leaf; Type II Reduced capitals, where all acanthi are more detailed and developed (Figure 306).
- Narrow-Trapezoid capitals presented with four corner acanthi and V-shaped volutes with coiling endings in two forms: firstly, volutes emerging from the corner acanthi and the V-shaped stems are moulded into the kalathos and barely visible (Figure 309); secondly, capitals with a prominent V-shaped volutes (Figure 310). These capitals are exceptions from the Type II Reduced Byzantine Corinthian capitals.
- Narrow-Trapezoid capitals with four corner acanthi only (Figures 311–314). These capitals are the majority of Type III and all of Type IV of the Reduced Byzantine Corinthian capitals. It is also notable that the acanthi of Type IV Reduced capitals have large, enclosed sinuses.



Figures 306-8. (left to right) Four-Leaf capitals in narrow trapezoidal form, Coptic Museum, Qalawon Complex and Graeco-Roman Museum (Pensabene)



Figures 309-11. Four-Leaf capitals in narrow trapezoidal form, Graeco-Roman Museum (left & right) and Coptic Museum (middle) (Pensabene)

⁴³⁴ Pensabene 1993: 158, 159, 160, 171.



Figures 312-14. Four-Leaf capitals in narrow trapezoidal form, Graeco-Roman Museum (left & right) and Wadi El-Natron (middle) (Pensabene)

Simplified Narrow Trapezoid-Shaped and/or Cylindrical-Shaped Capitals with Normal or Smooth Acanthi (Locally-Produced)

- Narrow-Trapezoid capitals with four corner acanthi and a central cauliculus holding a V-shaped infused calyx (Figures 315–317).
- Cylindrical-shaped capitals with four plain leaves at the corners of the capitals, with a central leaf in the middle of each side of the capital (Figure 319, 320).
- Cylindrical-shaped capitals with one row of smooth acanthi and very simplified carved V-shaped volutes without coiling endings (Figure 320).
- Simplified cylindrical-shaped capitals with outlined corner acanthi sometimes pinched with shallow sinuses. Their volutes, unlike the previous examples, are presented with a central cauliculus. The volutes and cauliculi are presented either in a prominent form (Figures 318, 321), or in a deeply carved form (Figures 322, 323).

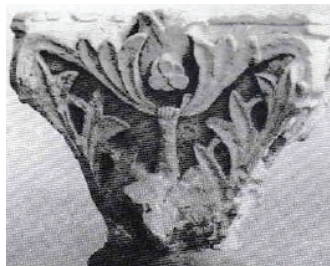

Figures 315-17. (left to right) Four-Leaf capitals in simplified trapezoidal form, Bawit/Louvre, Bawit/Graeco-Roman Museum and Saqqara/Coptic Museum (Pensabene)



Figures 318-20. (left to right) Four-Leaf capitals in cylindrical form, Bawit/Coptic Museum, Graeco-Roman Museum and Apa Geremais Monastery, Saqqara (Pensabene)



Figures 321-23. (left to right) *Four-Leaf capitals in cylindrical form, Kom Ombo Basilica, Apa Geremais Monastery, Saqqara and Temple of Hathor, Dandara (Pensabene)*

Ptolemaic- and Roman-Influenced (Alexandrian) Corinthian Capitals

This group consists of several unique capitals with a very close resemblance of the Ptolemaic Alexandrian capitals, the Corinthian capitals from the Samothrace and the late Roman Imperial capitals from the period of the Tetrarchy. Also, another related category that reflected previous designs from the Coptic was mainly characterized by having smooth or incomplete leaves. Also, certain models are presented in a very simplified manner, showing only corner volutes and the outline of the upper parts of the acanthi of both rows. Each row has its leaves connected in a wavy motif.⁴³⁵

- The earliest-recorded Late Antique example would be the capital from the Column of Diocletian at the Alexandrian Sarapeion, dated to AD 298. However, figure 324 predates that of Diocletian's Column, back to the 2nd century AD, showing how this design was originally a product of the Roman Imperial period. It is decorated with its smooth acanthi motifs; however, the entire motifs of the capital are smooth in their production, not only the acanthi – see Diocletian's Column, p. 126 for analysis and comparison.
- A group of two capitals (Figures 325, 326) have great resemblance to the capitals of the Proylon of Ptolemy II and the Rotunda of Arsinoe at Samothrace. They are dated between the late 5th century AD and the early 6th century AD. We can see how the double acanthus collar is presented, with its upper curved parts. Fully developed cauliculi emerge from the collar. Both volutes and helices presented in the concave and convex manners, adapted from the Type I Alexandrian Corinthian, without exaggeration or reduction in the size of either. However, we can notice that figure 325 has one calyx leaf, parallel to a second and a lesser cauliculus, of which the volutes and helices emerge. However, figure 326 has a normal calyx surmounting the upper rim of the Cauliculus, with its double leaves.
- Capitals belonging to the Type IV Reduced Corinthian capitals; dated between the second half of the 4th century AD and the early 5th century AD. They could be considered as a hybrid type of capitals between simplified imitations of Types I and IV Alexandrian Corinthian capitals and the Four-Leaf capitals (Figures 327, 328). Also, it could be considered two capitals with V-shaped volutes and corner acanthi attached and moulded together. The capitals have a single collar of separated acanthus leaves instead of the traditional double collar from the Ptolemaic period. Among the leaves emerge a singular stem that is divided into a V-shaped motif, forming volutes and helices. The volutes and helices imitate the Type I Alexandrian Corinthian designs of being in concave and convex motifs – see Type I Alexandrian, p. 32ff Corinthian in Chapter I for comparisons and analysis.

Figure 328 was labeled as a Corinthianized pilaster by Pensabene. However, this pilaster representation is the closest and most direct imitation to the Type I Alexandrian Corinthian capitals from the Ptolemaic period in the form of an outline. Such accuracy of imitation did not appear since the Augustan period. The pilaster is decorated with a single row of acanthus leaves, where the background gives an impression of the double collar. The acanthi, however, are represented in a dental and thorny form, adapting the Asiatic types of acanthi. Both volutes and helices emerge directly from the acanthus collar, where the helices' stems emerge directly from behind the volutes' stems. Regarding Figure 329, and by observing this

⁴³⁵ Pensabene 1993: 161, 427 & 428, 434, 447; cat. no. 518–520, 589, 590.

fragment, we can see that half of the Type IV Reduced Byzantine imitates the capitals with V-shaped volutes and coiling endings – see Figures 309-310.

- Capitals presented with smooth acanthi and volutes, where only the outline and the upper curved parts of the leaves are presented (Figures 329, 330); dated between the end of the 4th century AD and first half of the 5th century AD. Sometimes, the volutes are omitted, giving us capitals with smooth outlined acanthi, connected in a wavy-like motion.



Figures 324-26. (left to right) *Alexandrian-influenced capitals, Sultan Hassan’s Madrasah, Bawit and Saqqara (Pensabene)*



Figures 327-29. (left – middle right) *Alexandrian-influenced capitals, Graeco-Roman Museum (Pensabene)*

Figure 330. (right) *Alexandrian-influenced capitals, Coptic Museum (Pensabene)*

Moreover, by observing the previous two types of capitals (Figures 319–323; 329, 330), we notice a type of smooth or unfinished acanthi. These capitals were locally produced within the workshops of Alexandria and Abo Mina in the 4th century AD and towards the 7th century AD. They were directly related to church, monastic and funerary architecture.

All-Acanthus Corinthian Capitals

By the second third of the 4th century AD, Asiatic designs were abandoned gradually and capital designs started to take another turn by the Constantinian period. In other words, the Asiatic type was renamed as the Constantinopolitan type, with new and reused designs originally made in Constantinople or metaphorically imported and later applied. It was adapted directly in Constantinople. The thorny acanthi motives were abandoned in favor of larger, wider, round-leaf acanthi motives. Also, helices and volutes were omitted from the capitals in most cases, where it began with removing the helices entirely, followed by the omission of volutes, which was partially then fully abandoned. The design of capital of omitted helices and volutes, we find that calyces extending partially-horizontal, covering the upper part of the kalathos towards the bottom lip of the abacus, directly underneath it.⁴³⁶

Similar examples had appeared in Egypt, dated to the first half of the 5th century AD. Capitals from the White and Red Monasteries show similar designs with volutes or sometimes both volutes and helices. Corinthian capitals are presented with long acanthus leaves and volutes, where all of them are infused or almost infused together. These capitals are close to the Asiatic types, that their acanthi can be defined as thorny; a type of

⁴³⁶ Pensabene 1993: 169, 174, 175

capitals that was still known in Alexandria. However, according to McKenzie, it is probable that these models had firstly appeared in Alexandria.

These types of capitals abandon the thorny acanthus motifs. The capitals form these types, generally, follow the Asiatic designs; however, the entire capitals are covered in acanthi motifs. Leaves of the lower collar are always separated, or very close by the low most leaves. The midribs of the upper collars' leaves are always prominent. We notice how the lower acanthus row remains standard, while the upper leaves are elongated. Volutes are infused within the leaves of the calyces; sometimes presented in standard size (Figure 331) or a reduced one (Figure 300), but mostly replaced by the calyces leaves, which themselves are elongated towards the bottom of the abacus (Figures 334–339). Helices are completely removed and replaced by the inner leaves of the calyces, regarding examples at hand. Calyces are presented with V-shaped leaves; sometimes in straight (Figures 332, 333) or wavy (Figures 331, 338), or curved (Figures 336, 339) outlines. Figure 338 shows each of the calyces decorated with an embedded vine leaf. Cauliculi are presented in an acanthized manner, like those of the acanthus collar (Figure 334) or in a spiral, screw-like motif (Figures 332, 333) – see Red Monastery, p. 147ff, or an anthropomorphic motif of human arms (Figure 337). Figure 335 has its upper collar acanthi swollen, enlarged by the corners and center of the kalathos, while the calyces are reduced, presented in barely visible, thin lines, and omitted cauliculi.⁴³⁷



Figures 331-33. *All-Acanthus capitals, Hermopolis Magna (Pensabene)*



Figures 334-36. *(left to right) All-Acanthus capitals, Hermopolis Magna, Coptic Museum and Bahnasa/Graeco-Roman Museum (Pensabene)*

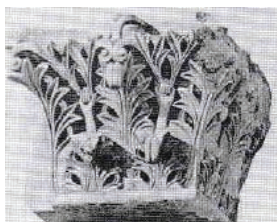

Figures 337-39. *(left - middle right) All-Acanthus capitals, Graeco-Roman Museum (Pensabene)*

⁴³⁷ For more analysis and similar capitals; see Pensabene 1993: 162, 437, 438, 445, 446; cat. no. 557–569, 584–586.

Impost Blocks and Capitals

The Impost architectural element was presented both as capitals and as capital elevators that support columns and are attached over the abacus of the lower capitals, acting as a second and lesser form of capital; for example, the interior arches, like the case with Hagia Sophia. Imposts are presented in a very simplified, inverted trapezoid form, with one central motif, usually a cross, and sharp corners (Figure 340). I shall be discussing other impost blocks within other context; i.e. in Ravenna's Basilica – see Figures 392-394. Pensabene dates these capitals to the second half of the 6th century AD.

Impost capitals also resemble an inverted trapezoid with a narrow lower base and a wide upper one. Their corners, unlike elevating impost, are very rounded, forming a smooth transition of motifs from one side to another. Impost capitals (Figures 341–343) are entirely covered with a web of intertwining motifs. However, we can notice that most examples at hand have a central rectangular motif surrounding a central palmette motif, where in figure 341, the motif covers most of the capital's face; while in figure 342, the central palmette motif is reduced.⁴³⁸ Similar, if not identical, examples are found at the Church of Hagia Sofia in Constantinople and the Church of St. Vitae in Ravenna – see Figures 391, 396.

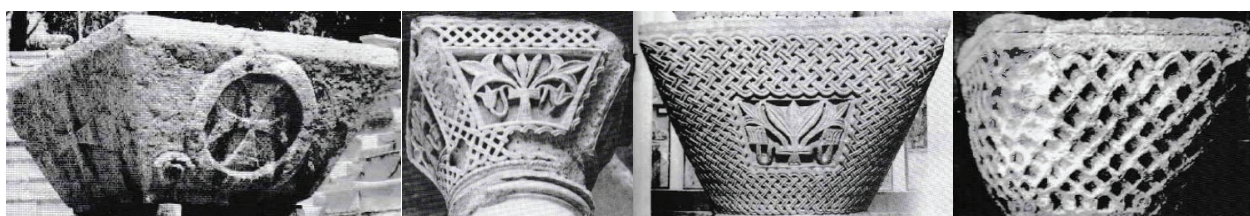

Figures 340-43 (left to right) *Impost capitals, Kom El-Dikka, Mosque of El-Nasser ibn Qalawon, Graeco-Roman Museum, and Coptic Museum (Pensabene)*

Basket and Melon Capitals

Basket capitals are another form of impost capitals, but rather all rounded. The entire capitals are covered with acanthus leaves. Acanthus motifs are presented as climbing, saw-like leaves, known as fold-capital – see Bawit below, or climbing acanthi fixed on one stem with dental-shaped leaves and round sinuses (Figure 345), or four collars of triangular-bent acanthi, known as leaf-capital – see Bawit, figs 162-163. Other types of Basket Capitals were discovered at the two churches from Bawit and Saqqara; capitals are on display at the Coptic Museum in Cairo. The capitals are dated to the middle of the 6th century AD.

From the same category of Basket Capitals comes a subcategory, where the capitals are not completely round. Each face of the capital appears in an irregular or wavy motion (Figure 345). A similar capital appears at Little Hagia Sofia, known as the Melon Capital – see Figure 401.



Figures 344-45. *A Basket capital, Louvre (left) and a Melon capital, Coptic Museum (right) (Pensabene)*

⁴³⁸ Pensabene 1993: 164.

Bizaonal Capitals

A category of Byzantine-influenced capitals had appeared by the second quarter of the 6th century AD, where the lower part is a basket and the upper has zoomorphic like the ram-head motifs (Figures 346, 347), or anthropomorphic representations for volutes, and a central motif in place of the abacus flower, where anthropomorphic motifs are infused with acanthus motifs in place of human facial hair (Figure 350), or acanthized cauliculi and calyces motifs (Figure 348). A subversion of the bizonal capitals has acanthi collars instead of the lower basket (Figures 347, 350).⁴³⁹ Similar examples are found in Constantinople and Thessaloniki – see Figures 406-411.

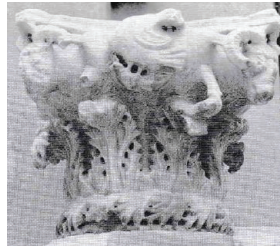
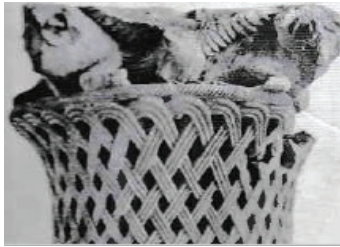

Figures 346-48. Two Bizonal Zoomorphic capitals, Graeco-Roman Museum (left) and a Bizonal Vegetal capital, Coptic Museum (right) (Pensabene)

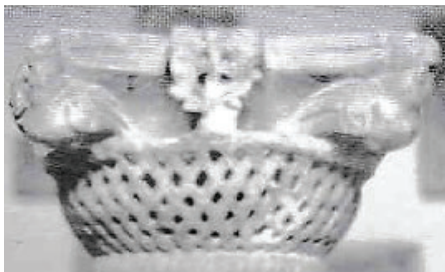

Figures 349-50. Two Bizonal Zoomorphic capitals, Coptic Museum (left) and Graeco-Roman Museum (right) (Pensabene)

Palm-Leaf Capitals

The design of such capitals goes back to Ancient Egypt, where capitals were decorated with a lower collar of papyri and lotus plants covering the rest of the capital. This practice remained throughout the Ptolemaic, Late Roman Republican and Roman Imperial periods. Most notable examples are the Tower of Winds in Athens and the interior arch with the Medusa-head motifs from the Severan Baths at Lepcis Magna – see Figure 244. Most notably is the interior of the Greek Church/Monastery of St. Sabas in Alexandria (Figure 353). The practice remained throughout Late Antique Egypt, as far as the 7th century AD – i.e. the Church of the Monastery of St. Sabas in Alexandria (Figure 353), where water plants were replaced with palm leaves. Also, like capitals from the Imperial period, they were presented as with (Figure 351) or without an acanthus collar (Figures 352, 353).⁴⁴⁰

⁴³⁹ Pensabene 1993: 171.

⁴⁴⁰ Pensabene 1993: 165, 171.



Figures 351-53. *Plam-Leaf capitals; with acanthus collar (Graeco-Roman Museum), simplified (Wadi El-Natrun), and standard (St. Sabas Church, Alexandria) (Pensabene)*

Wind-Blown Capitals

A type of Corinthian capitals, where the kalathos is covered with acanthi rows. Each row moves in an opposite direction from the rows above and/or below it, as if moved by the wind.⁴⁴¹ Unfortunately, only one capital (Figure 354) has been discovered in Egypt so far; a capital belonging to the Monastery of Apa Jeremias in Saqqara, dated to the 6th century AD. The capital is on display at the Coptic Museum in Cairo.⁴⁴² One side of the capital (Figure 355) shows the usage of volutes and the connection on both stems by the central cross motif. An identical capital can be found at the Church of St. Demetrius in Thessaloniki – see Figure 387.

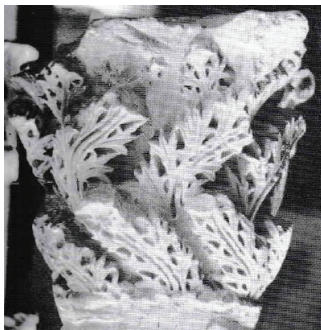

Figures 354-55. *Wind-Blown capital, Coptic Museum (Pensabene/Gabra)*

Corinthian Capitals within Context of Monastic Architecture in Late Antique Egypt

White Monastery (Deir Al-Anba Shenuda)

The White Monastery near Sohag lies near the Antique village of Atripe, in the region of Akhmim. It was built c. 440, on the site of an older, smaller church as a triconch.⁴⁴³ Christianity existed within the region before Shenuda; however, by the mid-4th century and 5th century AD, the monastic community had grown under his leadership. The name of the monastery was adapted from use of limestone in its construction.⁴⁴⁴

The monastery had witnessed a great destruction under the Sassanid invasion. By observing figure 356, we can notice and distinguish both original and reused capitals at the lower order of the eastern apse. The original capitals (to the right) are simplified, three-leaf or V-shaped and Four-Leaf capitals, while most of the wall of the apse is rebuilt, noticeable by observing the wall itself and the reused capitals.⁴⁴⁵ Same capitals were

⁴⁴¹ Pensabene 1993: 164.

⁴⁴² Gabra & Eaton-Krauss 2007: 83; Figure 39.

⁴⁴³ A triconch is the three, equated apses at the end of the church's nave, in our case.

⁴⁴⁴ Gabra 2002: 94, 95; McKenzie 2007: 272, 275.

⁴⁴⁵ I would like to hint that I will not be discussing the whole architecture of the monastery, only the capitals.

used in decorating the limestone slab representing the abbot (Figure 357).⁴⁴⁶ Also, the upper order is decorated with two types of Corinthian capitals; those supporting the upper frieze (Figure 356), and reduced capitals on the sides of the niches (Figure 358) with only two acanthi; a resemblance of the Four-Leaf capitals.⁴⁴⁷



Figure 356. (left) A wall section of the White Monastery – Blue-marked part resembles reconstructed part of the wall with reused capitals, while the red-marked part shows both the original wall and capitals (Coptic-Wiki)*

Figure 357. (middle) Stele of Apa Shenoute, depicting the original capitals presented in fig. 356 within the red-marked area. Stele on display at The Metropolitan Museum (Egypttoday.com)**

Figure 358. (right) A niche decorated with two simplified Corinthian capitals at the upper level – seen at Figure 356 (McKenzie)

Red Monastery (Deir Al-Anba Bishoi)

The Red Monastery lies few kilometers away from the White Monastery, within the same region, in the village of Nag'a Abo Azizah. The entire monastery was destroyed, except for the church and the keep of the tower; the church will be the focus of this section. The church proper is dated between the middle of the 5th century AD and the middle third of the 6th century AD. It follows the same architectural plan of the White Monastery, but about two-thirds of its size; a triconch church, with simplified motif representations. The architectural decorations of the church are the most preserved in situ from Late Antique Egypt. Although the church lied within a monastic complex, its artistic decorations were executed by professional artisans, not by monks.⁴⁴⁸

In case of the Corinthian capitals used at the Red Monastery's church, they were discussed thoroughly by Severin. Therefore, I shall be mentioning few examples, briefly, in regards of their typology and similarities/differences. Severin had divided the Corinthian capitals and pilasters as follows:⁴⁴⁹

⁴⁴⁶ The stele is accredited to: Stiftung Preußischer Kulturbesitz, Staatliche Museen zu Berlin—Skulpturensammlung und Museum für Byzantinische Kunst, Berlin (4475).

⁴⁴⁷ Gabra 2002: 99; McKenzie 2007: 275, 276.

* https://coptic-wiki.org/wp-content/uploads/2020/03/The_White_Monastery_28SOHAG29-the-white-monastery-sohag-143.jpg

** <https://www.egypttoday.com/Article/4/15667/'Christians-of-the-East'-exhibition-to-kickoff-in-September>

⁴⁴⁸ Gabra 2007: 101, 102; McKenzie 2007: 279; Severin 2008: 75–77.

⁴⁴⁹ For detailed analysis of each type of the Corinthian capitals and pilasters, and their distribution, see Severin 2008: 78–95; section A.2.

Capitals and Pilasters from the Triconch

Corinthian capitals used at the triconch of the church were divided into lower and upper orders. Lower order capitals have their kalathos broadened by the upper part of the capitals. Upper order capitals were presented in simplified motifs.

- All lower order capitals (Figures 359–361) have six leaves for their lower acanthus collar.
- All capitals from both upper and lower orders (Figures 359–362) have "soft acanthus."
- Figure 362 has seven leaves for the upper acanthus collar, while figures 360 and 361 have only five leaves.
- Figures 359 and 360 have their volutes and helices removed, while figures 361–363 have reduced volutes, infused with the calyces.
- Figures 359 and 360 have their cauliculi in a corkscrew-like motif, while figure 361 has its cauliculi presented in a stem-like motif for the calyces.
- Upper order capitals (Figure 362) have a "single pattern," with elongated lower acanthus row leaves, four leaves by the corners, omitted helices, and reduced, V-shaped calyces.
- Pilasters are decorated with two lower acanthi and three elongated acanthi; two supporting the volutes and one central leaf.
- Figure 363 is a reduced version of the pilasters from the triconch, where only three elongated leaves represent the acanthus collar, with the central leaf having a bead-like midrib. Calyces are reduced, thus showing larger-than-usual volutes.



Figures 359-60 (upper) & 361-63 (lower). *Several Corinthian capitals from the Triconch of the Red Monastery, Sohag (Severin)*

Capitals and Pilasters from the Façade

The façade is decorated with several types of capitals for its triumphal arch⁴⁵⁰ and...

- The lower acanthus row has six leaves on three sides (Figures 364–368).
- The upper acanthus row has three elongated acanthi; two on sides in place of the volutes, and one central leaf, extending towards the abacus (Figures 364–367).

⁴⁵⁰ Same capital was discussed in McKenzie 2007: 279; Figure 465.

- Cauliculi are presented in a corkscrew-like motif (Figures 364, 365, 367).
- Calyces are presented with a central cross for each calyx.
- The acanthi are presented as "soft acanthus" with the midribs of the upper collar leaves having "a row of beads" (Figures 364, 366, 367).
- The lower acanthi of figure 366 are presented as trefoil, with a central, inverted heart-shaped area, surrounding a thorny leaf with five leaflets.
- The central leaf from the upper collar (Figure 366) has bead-like motifs for its central ribs.
- Figure 367 has beads for central leaf midrib and cauliculi. Also, reduced central helices are presented and infused within the calyces along with the volutes.
- Figure 368 shows a niche from the triumphal arch of the façade, with a Four-Leaf capital, with V-shaped, coiled volutes. Similar capitals are found at the triconch niches.



Figures 364-66 (upper) & 367-68 (lower). Several Corinthian capitals and pilasters from the Façade of the Red Monastery, Sohag (Severin)

Capitals from the Naos

The capitals used for the Naos of the church were divided into two groups, based on their positioning in either the northern (Figure 369) or southern⁴⁵¹ (Figure 370) area of the naos.

- Both versions of capitals have eight acanthi for their upper and lower collars each.
- Acanthi follow the "soft acanthus" motif.
- Volutes and helices are omitted in both versions.
- Both versions have central motifs for the calyces, presenting rosettes inside a circle.
- Cauliculi and calyces are infused, forming a scale-like motif in covering the stem of the cauliculus, regarding the "North version" (Figure 369), while the cauliculi are visible, mounted by decorated calyces regarding the "South version" (Figure 370).

⁴⁵¹ The capital of the "Southern version" was also discussed in McKenzie 2007: 279; Figure 466.



Figures 369-70. Two Corinthian capitals from the Naos of the Red Monastery, Sohag (Severin)

Therefore, by observing the capitals from the church of the Red Monastery, we can conclude that all capitals from both the upper and lower orders, distributed throughout the triconch, the naos, and the façade follow the type of capitals of infused and acanthized motifs – see All-Acanthus Capitals p. 142ff. The niches, although reduced and painted, they fall under the category of Four-Leaf capitals, where, supposedly, the capitals are covered with only four acanthi, each at one corner. Examples at hand show volutes, intersecting at the center of the capital in a V-like motif.

Monastery of Apa Apollo, Bawit

The Monastery of Apa Apollo lies south-west of Hermopolis Magna, within the Libyan Desert. It was built c. end of the 4th century AD, and was in use until the second half of the 12th century AD. The monastery included two churches; North Church and South Church. In this case of study, the South Church concerns us the most. Also, since most of the discoveries were done under French missions, the Small Church was re-erected inside the Louvre Museum in Paris, with its capitals on display.⁴⁵²

Capitals used at the Small Church are divided into two groups of Basket Capitals, which we had already discussed above: Fold and Leaf Basket Capitals:⁴⁵³

Figure 371: A Fold-Capital, dated to the 6th century AD, and on display at the re-erected Small Church in the Louvre, Paris. It decorated with eight vertically-intertwined plant leaves, and two serpentine motifs, forming five circular motifs. The central circular motif is decorated with a cross, regarding the corners. Central serpentine motifs have their circular ones decorated with several motifs, like the fleur-de-lis at the top one, a fleur-de-lis mixed with an acanthus at the middle one, and a rosette at the lower one. The leaves are decorated with narrow teeth-like leaflets. Leaf endings join together, forming geometric figures.⁴⁵⁴

Figure 372: A Leaf-Capital, dated to the middle of the 6th century AD; on display at Louvre, Paris. The capital is wrapped with four superimposed rows of narrow acanthi, increasing gradually in size from bottom to top. Acanthus leaves are decorated with four central, drill-holed, circular sinuses each. The abacus is decorated with a slab; the slab is carved with two acanthi on both sides of a cross.⁴⁵⁵

⁴⁵² Bagnall & Rathbone (eds.) 2004: 175; McKenzie 2007: 295, 296.

⁴⁵³ Terminologies were presented in McKenzie 2007: 301; Figures 500, 501.

⁴⁵⁴ Pensabene 1993: 464; cat. no. 665; Gabra & Eaton-Krauss 2007: 82; Figure 38.

⁴⁵⁵ Pensabene 1993: 464, 465; cat. no. 667.



Figures 371-72. A Basket capital and a Melon capital from the Monastery of Apa Apollo, Bawit/Louvre (McKenzie)

Monastery of Apa Jeremiah, Saqqara

The Monastery of Apa Jeremiah was built c. 5th century AD, and was abandoned or destroyed somewhat between the 9th and middle of the 10th centuries AD. What concerns us is the Main Church within the area of the monastery; built at the same time and rebuilt after the Arab Conquest in the 7th century AD.⁴⁵⁶

Two types of capitals were found during the excavations at the Main Church. These types are divided into both Basket and Palm-Leaf Capitals, in which each of them is divided into two subcategories. All capitals, which will be mentioned, are on display at the Coptic Museum in Cairo. Both types of capitals are dated to c. second quarter of the 6th century AD.⁴⁵⁷

Figures 373-374: Two types of Basket capitals with hanging and inverted vine leaves. Figure 342 shows vine leaves with seven leaflets, neatly carved with details of its ribs and leaf divisions. Each leaf is surrounded with a heart-shape-like boarder. Smaller versions of the inverted vines are presented over the abacus in place of the fleuron. However, figure 374 has interlocking, serpentine motifs at the center and corner, like those from the Monastery at Bawit. However, they form six oval and circular motifs, unlike the five circular motifs from Bawit, and the central motif has a seventh oval motif over the abacus, in place of the fleuron. The capital shows its vine leaves with five leaflets, and without or almost-faded ribs. We can also notice two diamond-like leaflets on both sides of the vines by the low-most leaflet.⁴⁵⁸



Figures 373-74. Two Basket capitals from the Monastery of Apa Jeremiah, Saqqara/Coptic Museum (McKenzie)

⁴⁵⁶ Bagnall & Rathbone (eds.) 2004: 105; McKenzie 2007: 306.

⁴⁵⁷ McKenzie 2007: 311; based on the two cross-dating by Severin and Grossmann.

⁴⁵⁸ McKenzie 2007: 309, 311.

Figures 375-6: Two types of Palm-Leaf capitals. Both capitals have their leaves painted, with only the external outline and midribs carved. Figure 375 is shown with a single row of acanthus row; leaves are attached forming geometric figures. Figure 376 is shown without any acanthus collars, only the palm leaves.⁴⁵⁹

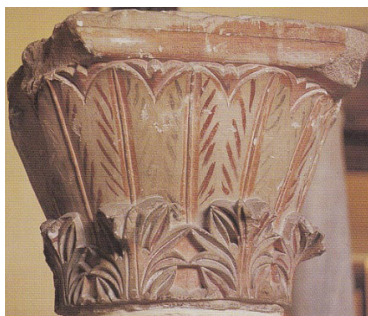

Figures 375-6. *Two Palm-Leaf capitals from the Monastery of Apa Jeremiah, Saqqara/ Coptic Museum (McKenzie)*

Therefore, after discussing the great variety of capitals that appeared in Alexandria and their reflections throughout other territories in Egypt, the following section will trace their appearance in the Byzantine. I will try and represent the masterpieces of Byzantine architecture throughout Constantinople and other important Byzantine centers.

The Alexandrian Corinthian Capitals in Byzantine Architecture

Although Pensabene had attributed the rise of earlier Late Antiquity Corinthian capital models from Constantinople to the 4th and 5th centuries AD, we see that McKenzie reversed his theory. McKenzie presented Alexandrian architecture to be prior to that of Constantinople; dated as 4th and 5th centuries AD in Alexandria and 6th century AD for the earliest surviving Constantinopolitan architecture.⁴⁶⁰

Also, very few examples remain from the early period of Constantinople from the 4th and 5th centuries AD. It seems that the period of Constantine the Great was a transitional period between the widely spread Asiatic types and the newly rising Constantinopolitan models. Constantine I paved the way for the rise of the Early Byzantine architecture rather than being an actual factor. Churches like the Lateran in Rome, which was previously discussed in regards of certain capitals dating to the Augustan period – i.e. see Figure 179, were about reusing older blocks from previous temples and of mixing various orders randomly. For Constantine I, constructions in Rome were mainly about reusing blocks rather than applying new styles, in contrast to the case of Constantinople; a case which was considered transactional.⁴⁶¹

The Historical Background of Certain Examples from the Early Byzantine Church Architecture

Usually, when I present certain examples, they are presented alongside the historical background of the monument itself. However, in case of Early Byzantine architecture, as I shall be discussing below, a monument could be presented with different types and versions of Corinthian capitals. Therefore, it is important to briefly introduce the important monuments with a large variety of capitals first. Other monuments with one or two versions of capitals will be introduced later in the next section.

⁴⁵⁹ Gabra & Eaton-Krauss 2007: 82; Figure 37. McKenzie 2007: 311.

⁴⁶⁰ McKenzie 2007: 329.

⁴⁶¹ Ousterhout 2019: 14, 17.

Hagia Sophia, Constantinople

The Church of Holy Wisdom was built in two phases; the second phase is the one witnessed today. The first phase of Hagia Sophia, known as "the pre-Justinianic Hagia Sophia," was built c. 340 under Constantine I. It was consumed by fire in c. 400, and then rebuilt in AD 415 under Emperor Theodosius II. The first phase remained until it was destroyed in the Nika Riots in the reign of Justinian. It was later rebuilt by the same emperor in AD 532–537. It was considered the epitome of Early Byzantine architecture. Examples from both phases will be discussed below, with relation to certain Late Antique Egyptian versions of the Corinthian design.⁴⁶²

Church of Theotokos Kyriotissa, Constantinople

Another example comes from the Church of Theotokos Kyriotissa in Constantinople. The exact dating of the capital is unknown. The earliest construction is dated to the 4th–5th centuries AD but, the current building is dated partially to the 6th–7th and 12th centuries AD; mainly a Middle Byzantine church. However, its capitals follow the same type of Asiatic-Based design from both Constantinople and Alexandria. The church provides two types of capitals; the Asiatic-Based and Melon/Fold capitals.⁴⁶³

Basilica of Bishop Philip, Stobi, Republic of Northern Macedonia

The city, currently in the Republic of Northern Macedonia, held a strategic position by the Romans as a nerve-hub of roads in the Balkans for both commercial and military importance. Very few are known about the city's religious life, except for few things, including the existence of bishops between the 4th and 7th centuries AD. From inscriptions, it is known that the largest basilica existed in the 5th century AD. The basilica was Hellenistic in its architectural construction; hence its decorations, including capitals. The capitals are from the nave and galleries, combining both Late Roman and Early Byzantine types of Corinthian pilasters – see Figures 412, 417–419.⁴⁶⁴

Church of St. Demetrius, Thessaloniki, Greece

The Basilica of Saint Demetrius was built in Thessaloniki in c. AD 412–413, during the reign of Theodosius II. It was originally built over the site of a small martyrium. During Heraclius' reign, between AD 610 and 641, the church was destroyed by fire and rebuilt, then again in 1917. Several Corinthian capital designs are used across the basilica, mainly the tribelon, the narthex and the nave. All capitals are dated to the 5th and 6th centuries AD.⁴⁶⁵ Examples at hand are mostly from the bay of the nave, according to the sketches by Texier.⁴⁶⁶ Since I was not able to acquire recent pictures of the capitals, I shall be using the sketches provided by Texier – i.e. see Figure 410.

Basilica of San Vitale, Ravenna, Italy

One of the most notably-decorated basilicas with Impost capitals is the Basilica of St. Vitale in Ravenna, Italy. The church was erected by Bishop Ecclesius in the reign of Amalasuintha, daughter of Theodric the Great, king of the Ostrogoths. The church was built on the site of a smaller church, when the bishop decided to improve it in the 520s, and consecrated on the 19th of April, AD 547.⁴⁶⁷ The church is decorated with highly decorated, four designs of Impost blocks and capitals, and one design of Melon capitals – see Figures 392–394, 402.

⁴⁶² McKenzie 2007: 329, 330, 334.

⁴⁶³ Theotokos Kyriotissa, *The Byzantine Legacy*, 4 May 2021, <https://www.thebyzantinelegacy.com/kyriotissa>

⁴⁶⁴ Hoddinott 1963: 161–163, 166

⁴⁶⁵ Hoddinott 1963: 125, 128, 130.

⁴⁶⁶ Texier 1864: 128.

⁴⁶⁷ Deliyannis 2010: 223–225.

Basilica of Sant'Apollinare Nuovo, Ravenna, Italy

The church was erected by Theodric the Great, king of the Ostrogoths, in the early 6th century AD. It was originally named Church of St. Martin the Confessor until the 9th century AD, when it acquired its current name. The interior of the church is decorated with columns, capitals and bases; all from Proconnesus marble. The capitals and impost blocks are all dated to the early 6th century AD. The capitals are marked with Greek letters from workshops identical to ones found in Constantinople; hence the architectural influence of Constantinople over Ravenna and exportation of marble.⁴⁶⁸ The nave provides us with various designs of Corinthian capitals – see Figure 381.

Constantinopolitan Corinthian Capitals within Byzantine Ecclesiastic Architecture in Relation to their Alexandrian Counterparts

In regards of the Early Byzantine art and architecture, it seems that researchers lean on discussing them from religious perspectives. Unlike the Hellenistic and Roman periods, Byzantine architecture resides around the functions and purposes of each section of the church or monastery, for instance. Therefore, I shall be taking the liberty of discussing the capitals thoroughly in terms of both date and their relation or similarities to capital designs in both Alexandria and Egypt, without discussing any motif from a religious perspective.

There is a misconception I would like to clarify before discussing Christian architecture. Christianity itself had existed throughout three stages within the Roman Empire; firstly from the crucifixion of Jesus until Diocletian, which was more or less a period of religious persecution; secondly, under Constantine, it became a religion of the empire; and finally, under Theodosius I, it became the sole religion of the empire. The difference between the two periods of Constantine and Theodosius is that under Constantine, Christianity co-existed alongside paganism, which Constantine did not fully eradicate. However, from the reign of Theodosius onwards, paganism was prohibited and Christianity took over entirely. A similar conception could be applicable in case of the gradual architectural changes – i.e. Corinthian capitals and their derivatives, in case of this study.

By the time of Constantine I onwards, architecture took a different path from the previous ones seen throughout the Hellenistic and Roman periods. As seen in the previous chapter, the Arch of Constantine, for example, was originally erected using *spoila* capitals; a reason for the reusing of the canonical capitals. However, with the expansion of Byzantium and renaming it into Constantinople, we witness a new form of architecture, mixing both eastern and western styles – i.e. see Figure 390 found in both Alexandria and Ravenna.⁴⁶⁹

It had come to my attention that churches, from the Early Byzantine period until Justinian I, follow two main decorative elements in regards of their versions of the Corinthian capitals.

First, like the case of Egyptian monasteries, churches are built using different versions of the Corinthian capitals. I would like to assume that this was probably an adaptation from the tradition of reusing capitals of different orders. Therefore, it was later arranged and capitals distributed across the church – i.e. the naves and aisles – differ accordingly.

Second, capitals used across Byzantine territories are more likely to be presented in the Composite version of capitals, rather than the original versions from Egypt or Syria. Several examples of capitals, which I shall be discussing below, have the main design adorned with two Ionic volutes. Although I have avoided discussing Composite capitals from both Hellenistic and Roman periods, there was no escaping them in the Early Byzantine period; probably a favorite of the period.

⁴⁶⁸ Deliyannis 2010: 146–148, 150.

⁴⁶⁹ Ousterhout 2019: 102.

Asiatic-Based Corinthian Capitals

In regards of the Asiatic-Based types of Corinthian capitals, we can categorize them into three subgroups, based on both the volute and calyx designs:

Capitals with volutes emerging from calyces

The first phase of Hagia Sophia in Constantinople had provided us with an Asiatic-based capital (Figure 377) from the early 5th century AD. The capital belongs to the Porch of Theodosius II. The capital is an identical of a Type III Byzantine capital from Alexandria. Both capitals have the same intersecting lower acanthus collar, the fleur-de-lis leaflets with four midrib sinuses and the horizontal stems of volutes. Helices are totally omitted.⁴⁷⁰

The Column of Marcian in Constantinople was erected in honor of Emperor Marcian between AD 450 and 452. The Corinthian capital (Figure 378) decorating the column is in a very bad condition, tied with metal chains to keep it intact. The remaining visible motifs of the capital show the double acanthus collar and two calyces emerging directly from the collar without cauliculi. Helices are removed, and the volutes emerge with disorientation in relation of the calyces; both features are found in Alexandria.⁴⁷¹

The Column of Aelia Eudoxia was erected in AD 403, honor of Emperor Acradius' wife. The column stands near Hagia Sophia in Constantinople. Most of the few historical sources about the column focus around the base and the inscription on it. However, by observing the capital (Figure 379), we can notice that it follows the same Asiatic-based design of Capitals from both the first phase of Hagia Sophia and the Column of Marcian. The double acanthus collar has intersecting leaves, forming geometric figures. The volutes have disoriented relation with the calyces, which mount two cauliculi. The partial presence of cauliculi is a rare trait in the 5th century AD.⁴⁷²



Figure 377. (left) *Asiatic-Based Corinthian capital, garden of Hagia Sophia (McKenzie)*

Figure 378. (middle) *Reconstruction of the Asiatic-Based capital of the Column of Marcian (Wikipedia)**

Figure 379. (right) *The Asiatic-Based capital of the Column of Aelia Eudoxia (Fliker)***

It appears that this type of capitals with omitted helices and vertical volute stems is originally an Alexandrian design. This is proven by the previously-discussed Alexandrian limestone models, which predate both

⁴⁷⁰ Pensabene 1993: 422; McKenzie 2007: 330.

⁴⁷¹ Column of Marcian, *The Byzantine Legacy*, 4 May 2021, <https://www.thebyzantinelegacy.com/marcian-column>.

*

https://upload.wikimedia.org/wikipedia/commons/2/20/A_history_of_architecture_in_Italy_from_the_time_of_Constantine_to_the_dawn_of_the_renaissance_%281901%29_%2814597482728%29.jpg

** <https://www.flickr.com/photos/byzants/38308176116>

⁴⁷² Column of Aelia Eudoxia, *The Byzantine Legacy*, 6 May 2021, <https://www.thebyzantinelegacy.com/eudoxia-column>.

Constantinopolitan and Alexandrian marble versions in Alexandria by few decades, and the Constantinopolitan versions from Constantinople by nearly half a century.

Capitals with volutes emerging directly from the acanthus collar

The capital from the Church of Theotokos Kyriotissa in Constantinople (Figure 380) resembles that from the first phase of Hagia Sophia; 4th–5th or 6th–7th centuries AD. It is decorated with a double acanthus collar, where its thorny leaves intersect, forming geometric figures. Cauliculi, calyces and helices are omitted, while the volutes are crushed between the acanthus leaves of the upper collar and the lower lip of the abacus.

Basilica A in Philippi, Macedonia, Greece is dated to the end of the 5th century AD. However, in regards of its Corinthian capitals (Figure 381), it is believed that the capitals are dated to an earlier date. They are identical to the capitals from the Basilica of Bishop Philip in Stobi. Therefore, Hoddinott concludes that the capitals are either an imitation of Constantinopolitan models by expert artists or reused from an earlier period of Late Antiquity.⁴⁷³ Identical capitals can be found at the so-called Sultan Cistern in Constantinople, dated to the 6th or 7th centuries AD (Figure 382).⁴⁷⁴



Figure 380. (left) *An Asiatic-Based capital from the Church of Theotokos Kyriotissa (Byzantinelegacy.com)*

Figure 381. (middle) *An Asiatic-Based capital from Basilica A, Macedonia, Greece (Wikipedia)*

Figure 382. (right) *An Asiatic-Based capital of the so-called Sultan Cistern (Byzantinelegacy.com)*

Based on the dating of both the Church of Theotokos Kyriotissa and Basilica A, they hardly predate the Alexandrian models of this type of Corinthian capitals used in the decoration of these churches. Since Alexandrian models go back to the late of the 4th century AD, there is a probability of about one century difference, where the Alexandrian models could be considered as a source of influence regarding this type.

Four-Leaf type of capitals, adorned with one acanthus collar and V- or U-shaped volutes

Another capital on display at the Garden of Hagia Sophia (Figure 383) is dated to the 5th–6th centuries AD. The capital is decorated with a single collar of acanthi – intersecting leaves form geometric figures, four corner leaves and U-shaped volutes. This type resembles both the Asiatic-based type and Four-Leaf capitals with V-shaped volutes, but rather as a modified version. A similar capital appears at the Basilica of Sant'Apollinare Nuovo in Ravenna from the 6th century AD (Figure 384). However, the capital seems to be a failed attempt, since there is a lack of symmetrical patterns. The carving of the acanthi is shift towards the right, instead of being vertically underneath and perpendicular with the abacus fleuron and the central interaction point of the volutes' stems.

⁴⁷³ Hoddinott 1963: 169, 173.

⁴⁷⁴ Sultan Cistern, *The Byzantine Legacy*, 6 May 2021, <https://www.thebyzantinelegacy.com/sultan-cistern>.

From the "triple window of the narthex" of the Basilica of St. Demetrius in Thessaloniki, we find a type of capitals, labeled by Hodinott as "Acanthus capital," dated to the 5th century AD (Figure 385).⁴⁷⁵ This capital is a developed version of the Four-Leaf capitals. The lower acanthus collar has four acanthi at the center of each side of the capital, with their leaflets intersecting by the corners, forming geometric figures. The upper part of the collar is the part resembling the Four-Leaf capitals, where each corner is decorated with one acanthus leaf. The center of the capital is decorated with V-shaped volutes, identical to the Reduced Byzantine versions from Egypt – see Four-Leaf capitals, p. 139-140.



Figure 383. (left) A Four-Leaf capital from the garden of Hagia Sophia (Byzantinelegacy.com)

Figure 384. (middle) A Four-Leaf capital from Basilica of Sant'Apollinare Nuovo, Ravenna (Byzantinelegacy.com)

Figure 385. (right) A Four-Leaf capital of the Basilica of St. Demetrius, Thessaloniki (Byzantinelegacy.com)

It is difficult to identify which of the two models predates the other, since both models lie within the same period; 2nd half of the 5th century AD – 6th century AD. However, based on the theory presented by McKenzie and the relation between this type and the Hellenistic Type IV Alexandrian Corinthian capital, in addition to the wide variety of Alexandrian models within the Four-Leaf models, we could conclude that the Alexandrian models predate the Constantinopolitan ones.

Wind-Blown Capitals

This design of capitals was previously discussed, found at the Monastery of Apa Jeremias in Saqqara, dating to the 6th century AD – see Figure 355. It appears that this type of capitals was not originally an Alexandrian/Egyptian invention. Similar designs appear at the Church of St. Demetrius in Thessaloniki – see Figure 387. Also, within Northern Mediterranean Byzantine territories, this wind-blown motif was introduced as part of the Composite capitals, unlike in Alexandria and Syria. Therefore, we can conclude these types of capitals had no canonical design, but rather carved from the artists' point of view.

In Syria, near Antioch, the Church of St. Symone Stylites, dated c. 480–490 has a similar design of capitals (Figure 386). By observing the capital, we can notice two rows of acanthi, moving to the right, in the same direction. Both rows follow the same direction in regards of their orientation; unlike Alexandria, which shows both rows blowing in opposite directions. Also, both volutes and central cross motifs were added to the Alexandrian model.⁴⁷⁶ The capital is decorated with two cork-screw-like cauliculi with calyces; an Alexandrian feature.

⁴⁷⁵ Hodinott 1963: pl. 28a.

⁴⁷⁶ Ousterhout 2019: 65

Another example, probably the most known example of Wind-Blown capitals is the capital from the nave of the Basilica of St. Demetrius in Thessaloniki (Figure 387). Like the model from Saqqara, the two acanthi rows blow in different directions. However, the type of acanthi used is smoother than that from Egypt, which is thorny. Researchers tend to categorize this capital as Composite capital; however, by observing the upper part of the kalathos and the acanthi motif decorating the area between the volutes, it is difficult to determine whether the stems of volutes are horizontal or growing from behind the mid-upper rim. The capital is more open to interpretations.

Another capital is a reused capital from Hagia Sophia in Thessaloniki (Figure 388). Based on the relation of the capitals of the nave within the cathedral, it appears that certain wind-blown capitals were reused. Although the cathedral was built in the 8th century AD, such capitals may be dated to an earlier church, which was destroyed in c. 625.⁴⁷⁷ By observing the capital, we can conclude that the leaves are opposite to the capital from St. Demetrius. However, both volutes are small in size and emerging from two calyces; an indication of being Corinthian rather than the common Composite design, which was more popular in Byzantine territories.

Another capital is found at the Church of Sant'Apollinare in Classe, dated to the second half of the 5th century AD (Figure 389).⁴⁷⁸ By observing the capital, we can notice that the wind-blown acanthi from this capital are unique. Usually, leaves of each row tend to follow the same direction of wind. However, regarding this capital, each of the four faces has two acanthi blowing in opposite directions and both emerge from the same stem and midrib.



Figures 386-89. (left to right) Wind-Blown capitals from Antioch, Thessaloniki (2 capitals), and Classe (Oberhout)

Most recent discoveries available at hand show that the Syrian model predates both the Alexandrian and Constantinopolitan ones. However, it is not a fair comparison, since only one capital had been discovered in Egypt so far, which could be contemporary to the Syrian models, only a couple of decades afterwards. Therefore, it is difficult to conclude the origin of this type of capitals; least we can say is that the model itself is not Constantinopolitan, either Syrian, so far, or Egyptian.

Impost Capitals

The Church of St. Poleuktos in Constantinople was a contemporary to and immediately built before Hagia Sophia, c. 524–527. One of the several capital designs used was the Lotus-Panel capitals; a form of Impost capitals. Identical capitals were uncovered in Alexandria. In this Constantinopolitan model (Figure 390), the lotus panel is always presented large in size, covering most of the capital's face. The surface is covered with a narrow web of intertwining motif. Since the previously mentioned examples from Egypt are locally made and belong to the 6th century AD, we can assume that these types of capitals had direct influence from Alexandria.⁴⁷⁹ Forth Crusade *spoila* capitals taken from the same church are found the Basilica San Marco in

⁴⁷⁷ Geymonat 2012: 54.

⁴⁷⁸ Ousterhout 2019: 105.

⁴⁷⁹ McKenzie 2007: 332, 334 & 339.

Venice. Also, 6th century capitals with the same lotus panel from the Basilica of St. Vitale (Figure 391) are identical to the capitals from both St. Pouleuktos and Alexandria.



Figures 390-91. *Two identical Impost capitals from Alexandria (left) and Ravenna (right) (Oberhout)*

The Basilica of St. Vitale in Ravenna has more than one design of Impost capitals. We can find two designs of Impost capitals for the lower order, and one design for the upper one. Capitals from the lower order (Figures 392 & 393) are decorated with wavy, serpentine motif in shape of a frame. Within the frame is a panel of randomly intersecting acanthi leaves and leaf stems. The difference between the two designs is that the first one has a central cruciform-like motif of five circles, each containing a gilded leaf. The other capital has the same motif, in addition to two other semi-circular gilded motifs at the bottom of the central panel. Also, by observing the upper impost blocks, we can notice that the first design of capitals has an impost block of two horses face each other, with a giant, gilded cross in the middle. The other design has its impost block decorated with two birds, probably peacocks, facing each other, with a vase or amphora between them. The capital design for the upper order (Figure 394) is much simplified than that of the lower one. All capitals consist of a frame of a continuous palm leaf on three sides. The central panel, like the lower order, has acanthi leaves and stems intersecting randomly. However, the center of the panel has one blank circular motif. Probably, the capital is either left incomplete – a central panel for a cross, or was intended to appear in a simplified manner.

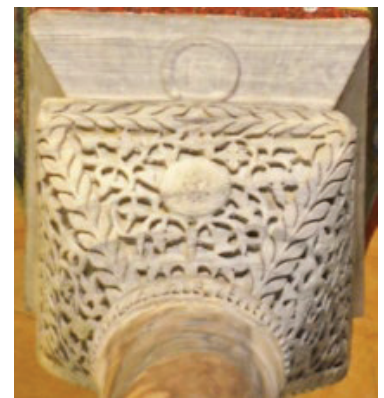

Figures 392-94. *Impost capitals with impost blocks from the Basilica of St. Vitale, Ravenna (Oberhout)*

It is clear that Alexandrian model of Impost capitals predates the Constantinopolitan ones. The Alexandrian model is dated to the second quarter of the 4th century AD, while its identical counterparts from Constantinople and Ravenna are dated to the 6th century AD; two centuries of difference, yet the model was preserved in an identical manner, in addition to other varieties and developed models.

Basket & Melon Capitals

Regarding the second phase of Hagia Sophia – c. 530s, the capitals (Figures 395 & 396) decorating the church are presented in two forms: capitals and pilasters; they all share the same body motif of having two sides covered with two elongated and sharp acanthi with a central monogram motif, while the other two sides are

covered with five rows of winged-like acanthi emerging from the central serpentine motif. Capitals and some of the pilasters are presented with Ionic volutes in the form of Composite capitals. Other pilasters are presented without the Ionic volutes in the form of standard, square-shaped Basket capitals.⁴⁸⁰

In Philippi, Basilica B, an unfinished 6th century church, was decorated with Basket capitals that reflected the Constantinopolitan influence. The capital (Figure 397) is identical to the nave capitals from Hagia Sophia in Constantinople with their two large thorny acanthi on each side, save for the Ionic volutes and central monogram.⁴⁸¹

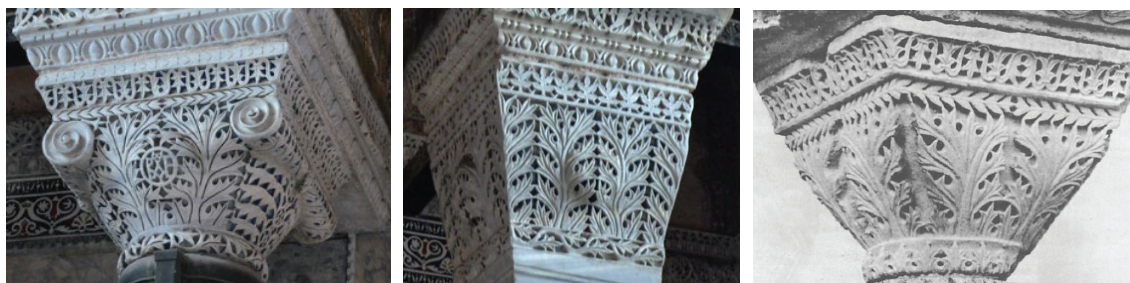

Figures 395-97. Basket capitals from Hagia Sophia, Constantinople (left and middle), and Basilica B, Philippi (right) (McKenzie/Hoddinott)

Little Hagia Sofia, or the Church of Saints Sergios and Bacchus, in Constantinople was built c. 530 in the reign of Justinian I. The lower order of capitals is known as fold-capitals or Melon Capitals. The capital is composed of "eight-lobe horizontal section" adapted from Egyptian architecture – i.e. the Birth House in Dandara. The surface of the capital is decorated with sharp acanthi emerging from a central point. These capitals (Figure 398) have resemblance to the Basket Capitals from both the monasteries of Saqqara and Bawit regarding the full-covered surface with acanthi and the central interlocking, serpentine motif.⁴⁸²

Several other Melon capitals can be found across other Byzantine territories and monuments. Mainly, all Melon capitals are covered with serpentine motifs; two at the center of each face, and one by each corner. Number of circular motifs formed by the intersection of the serpentine motifs could vary, based on the size of both or either the capital and/or diameter of the circular motifs. Most notable examples are:

- Also, another capital, probably still on display outside Hagia Sophia within the court or garden premises, is a Melon capital (Figure 399). The capital follows the same design of leaves and serpentine motifs from the Egyptian capital.
- A Melon capital, from the Church of Theotokos Kyriotissa, embedded in a wall, supporting part of an arch with frescoes (Figure 400). The capital is dated to the 4th–5th centuries AD. The capital, generally, is small in size, with large acanthus leaves.
- A Melon capital from the nave of the Basilica of St. Demetrius in Thessaloniki (Figure 400); early 6th century AD. Acanthus leaves are small and thorny.⁴⁸³
- A Melon capital from Little Hagia Sophia; c. 530s (Figure 401). The capital is decorated with sharp and small acanthi all over the capital and within the circular motifs.
- Aside from the Impost capitals of the Church of St. Vitale in Ravenna is a Melon capital belonging to the lower order (Figure 402). The capital is dated to the mid. 6th century AD. It is small and size, probably smaller than that from the Church of Theotokos Kyriotissa.

⁴⁸⁰ Cruickshank 1996: 306; McKenzie 2007: 344.

⁴⁸¹ Hoddinott 1963:190, 191.

⁴⁸² Pensabene 1993: 462 & 463; McKenzie 2007: 341, 343.

⁴⁸³ Same capital was sketched by Texier, but rather as a round Basket, and not as a Melon or Fold capital.

However, all eight sides of the capital are covered with triple circles from the serpentine motif, rather than triplets and quadrats. Also, the upmost and low-most corner circle motif surrounds a Roman-type acanthus, not just thorny motifs.



Figures 398-402. *Several Melon capitals from Constantinople, Thessaloniki and Ravenna (McKenzie/Wikipedia)*

The Alexandria model is less developed than the Constantinopolitan models. However the Alexandrian capital, although more of a Basket than a Melon, it predates them, back to the second quarter of the 4th century AD; the dating is for both the Basket and Melon capitals.

Four-Leaf Capitals

Several capitals from the Balkan regions were recognized as parallels to the Four-Leaf capitals from Alexandria. Models included capitals both with and without volutes. Not all capitals were discussed in details; mostly were just hinted as simplified Corinthian capitals. Therefore, I shall be analyzing these capitals from my point of view.⁴⁸⁴

- A capital (Figure 403) from the Basilica at Suvodol, Serbia; dated to the first half of the 6th century AD. The capital Four-leaf with only acanthi by the corners. The abacus' fleuron is represented as an inverted triangle. Leaflets intersect, forming geometric figures.
- A capital (Figure 404) from the Cruciform Church in Caričin Grad, also known as Justiniana Prima in Serbia; dated to the 6th century AD. The capital is trapezoid, with four leaves by the corners. The leaves are simple, with "highly formalized acanthus leaves." Leaflets intersect, forming four triangular motifs in the middle of the capital's side. The capital belongs to the chancel screen.
- A capital (Figure 405) from the Domed Church in Konjuh, Republic of North Macedonia; dated to the 6th century AD. The capital is decorated with four leaves by the corners and V-shaped volutes intersecting at the center of the capital's base. The capital belongs to the chancel screen.



Figures 403-5. *Reconstruction of three Four-Leaf capitals from the Balkans (Hoddinott)*

These Four-Leaf capitals could be considered as a simplified version of the Alexandrian models. Since the Alexandrian models are dated as far as the 4th century AD, while these capitals are dated to the 6th century AD, it is obvious that they are modeled after the Alexandrian ones. Also, by observing the Alexandrian models, we can conclude that these Constantinopolitan models follow the Type IV Reduced Corinthian capitals, which themselves are a reduced subgroup of the Four-Leaf models – see p. 137-141.

⁴⁸⁴ Hoddinott 1963: 203, 204, 220, 221.

Bizonal Capitals

Bizonal capitals from Constantinople and other Byzantine territories were not presented in a great variety like in Egypt. Unlike the anthropomorphic and zoomorphic representations from Egypt, other Byzantine Bizonal capitals stuck to certain motif, mostly eagle-like motifs. Most of the notable examples are:

- A Bizonal capital appears at Hagia Sophia, Constantinople (Figure 406). Most of the capital is damaged; however, we can notice that the lower part of the capital is covered with a narrow net-like collar-motif, similar to the net motifs covering Impost capitals. The upper half has four eagles, one at each corner in place of the volutes. There appears to be a central motif but badly damaged and unclear. By deeply observing it and by comparing this capitals to the capitals from the Basilica of St. Demetrius from Thessaloniki – see Figure 409-411, we could deduce that it is a Cornucopia motif. The exact date was not mentioned by the available source; therefore, it might belong to the second phase, 5th–6th centuries AD.
- A Bizonal capital, assumed to be from the Hippodrome of Constantinople; c. 6th century AD (Figure 407). It is decorated with a single acanthi collar with drilled sinuses. About two thirds (2/3) of the kalathos is covered with winged Pegasus motifs in place of the volutes. The capital is on display at the Istanbul Archeological Museum.
- A Bizonal capital with anthropomorphic motifs by the corners and a central cornucopia by each side. The capital is known as the "Green Man" and it is on display at the Istanbul Archeological Museum (Figure 408). A capital with similar features is found in Egypt.⁴⁸⁵ Exact date was not mentioned.
- Three Bizonal capitals from the Basilica of St. Demetrius in Thessaloniki are found at the nave, having their upper halves decorated with zoomorphic motifs (Figures 409–411). The basilica is dated to the 5th century AD. One capital is dated to the 5th century AD, where the corners of the capitals have ram heads in place of the volutes. The central motif at the upper part of the capital is an eagle on one side. The other two capitals from the 6th century AD have eagle motif in the corners, in place of the volutes. Both capitals have a central Cornucopia-like motif. One capital has the lower part wrapped with a basket-like motif, decorated with acanthi. The other capital has the lower part of the kalathos wrapped with a single collar of acanthus leaves. Both capitals with single rows of acanthi collars have counterparts similar from Egypt – see Figure 347 for a close match from Egypt.
- One Bizonal capital from the nave of the Basilica of Bishop Philip in Stobi, Republic of North Macedonia (Figure 412), dated to the 5th century AD.⁴⁸⁶
- A Bizonal capital decorated with griffin motifs in place of the volutes and two central, intersecting cornucopias (Figure 413). The capital is one of four, decorate the Ciborium of the Euphrasian Basilica in Poreč, Croatia, built in the 15th century AD, but the columns and capitals belong to the original Ciborium from the 5th–6th century AD.⁴⁸⁷



Figures 406-9. Three Bizonal capitals from Constantinople and one from Thessaloniki (Fletcher, *Byzantinelegacy & Outerhout*)

⁴⁸⁵ Hagia Sophia, *My World of Byzantium*, 8 May 2021, <https://www.pallasweb.com/deesis/columns-and-capitals-of-hagia-sophia.html>

⁴⁸⁶ Hoddinott 1963: 166

⁴⁸⁷ Ousterhout 2019: 105; Episcopal Complex of the Euphrasian Basilica in the Historic Centre of Poreč, *UNESCO*, 8 May 2021, <https://whc.unesco.org/en/list/809/>



Figures 410-13. *Three Bizonal capitals from Thessaloniki and one from Poreč (Texier, Hoddinott & Outerhout)*

Alexandrian-Based Corinthian Capitals

There is a variety of mentioned and/or unconsidered capitals that are related to Alexandria. These capitals were mentioned, in other cases were neglected, as part of a church or monastic construction, without being related to its origin. Therefore, I took the liberty of analyzing these capitals from my own point of view.

- A pilaster from the chancel of the Basilica of St. Vitale in Ravenna (Figure 414). Although the capital was not previously discussed, at least within the sources at hand, it came to my attention its Alexandrian design. The pilaster is decorated with two volutes coiling towards the center of the kalathos. The pilaster is decorated with a reduced acanthus collar of three leaves. Generally, it resembles the Hellenistic Type IV Alexandrian capitals – see p. 41ff, and the Proto-Corinthian models from Pompeii – see p. 70ff.
- A capital dated to the 5th century AD from Basilica A in Philippi (Figure 415). The capital is almost an identical imitation of the Type I Alexandrian Corinthian capitals. The capital is decorated with both volutes and helices, emerging from two calyces. The calyces are infused within the upper row of the acanthus collar, making it unnoticeable without accurate observation. The double acanthus collar has standard Greek acanthi. A normal fleuron decorated the abacus.
- A pilaster from the rotunda of the Myrelion Church, Constantinople; 5th century AD. The capital is on display at Istanbul Archeological Museum (Figure 416). The capital is an identical imitation of figures 328 and 329 from the Late Antique period of Egypt, similar pilasters unearthed in Alexandria.
- A set of capitals from the crypt underneath the Basilica of Bishop Philip in Stobi. The capitals (Figures 417-419) imitate the previous example from the Myrelion Church, but in rather various designs. The exact date is unknown, probably 5th century AD, since the crypt was originally a Roman bathhouse, later converted to be a crypt.⁴⁸⁸



Figures 414-16. *Three pilasters with similarities to Types I and IV of the Alexandrian Corinthian Capitals (Wikipedia, Hoddinott & byzantinelegacy)*

⁴⁸⁸ Hoddinott 1963: 164.



Figures 417-19. Three pilasters with similarities to Type I of the Alexandrian Corinthian Capitals (Hoddinott)

Mostly, Byzantine models based on Alexandrian models revolve around the Type I Alexandrian. We can see how both volutes and helices, regarding the design of the helices, are projected from the same cauliculi and/or calyx. We can see the return of the central fleuron with the standard fleuron designs. The exception from Ravenna by reintroducing pilasters based on the Type IV Alexandrian is unique to this period of time, which reflects the revisiting of older designs and applying them to their contemporary art.

Palm-Leaf Capitals

Unlike the case in Egypt, Palm-Leaf capitals were not very common in the other Byzantine territories; at least as far as current excavations, researches and references at hand are concerned. A notable example is found at the Basilica of St. Demetrius in Thessaloniki. A type of capitals (Figure 420), decorated with two rows of palm leaves and bird-like motifs by the corners in place of the volutes, was used in decorating the external of the building; one of many capital designs used. Although the capital was not academically discussed, I assume that it was indirectly influenced by previous both Egyptian/Alexandrian⁴⁸⁹ and Roman lookalike capitals from previous eras. There is a Composite capital presented by Pensabene from Alexandria, which applies the same design of acanthi, but only for the lower row. Probably, it could be a starting point for another researcher to follow the steps of development within the Composite capitals.

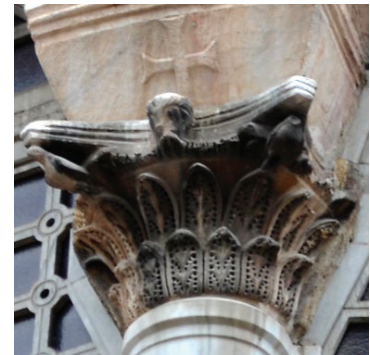

Figure 420. A double-row Palm-Leaf capital from Thessaloniki (Wikipedia)

Therefore, by discussing the variations of the Corinthian and Corinthian-related capitals within Alexandria and Egypt, and comparing them to their Constantinopolitan counterparts, we can conclude and prove that Alexandria had the superior hand and was the main source of influence as follows:

- Alexandrian models of the Asiatic Corinthian capitals from the Imperial period paved way into the making of a new type of capitals based on the Asiatic designs. Mostly, these models revolved around omitting the central helices. They appeared between the late 4th century AD and the 6th century AD.
 - ▶ Limestone capitals are dated to the early/middle of the 4th century AD and middle of the 5th century AD.
 - ▶ Marble capitals came about half a century later; dated to the second half of the 4th century AD and the 5th century AD.
- A distorted locally-produced version of the Asiatic-based capitals appeared. The acanthi were very thorny and the volutes were in a disoriented relation with the calyces.

⁴⁸⁹ McKenzie 2007: 234.

- Constantinopolitan models of the Corinthian capitals based on the Asiatic models were adapted from Alexandria after nearly half a decade; early 5th century AD. Data available did not present other capitals afterwards, starting from the middle 5th century AD.
- A reduced form of capitals, related to the Type IV Alexandrian capitals, appeared with two motifs, mainly; dated 4th century AD. Capitals were decorated with four leaves by the corners, and sometimes with a central one, as well as a fleuron, mostly in a diamond-like motif. These capitals had counterparts within the Balkans, but rather in a more simplified version. The Byzantine counterparts were presented later; 6th century AD.
- Some Constantinopolitan models were designed based of the Four-Leaf capitals, in addition to a lower acanthus collar, which was added to the capitals, giving them a unique design; generally like both Types I and IV Alexandrian infused.
- A more simplified version of the Four-Leaf capitals was locally produced, with smooth acanthi and either prominent or carved-in V-shaped volutes.
- The adaptation of the Type I Alexandrian Corinthian capital throughout several designs, including the capital from the Column of Diocletian.
- Capitals completely covered in acanthi – with replacement of volutes and helices with the acanthized calyces – had no counterpart within the Constantinopolitan models; probably treated as a local production, since they mostly belong the parts of Upper Egypt, which had difficulty of acquiring marble productions.
- Corinthian-related capitals appeared, in the beginning, in Egypt, c. 4th century AD:
 - ▶ Impost capitals with lotus panels from Alexandria were adapted in Constantinople and Ravenna without any changes in the motifs.
 - ▶ Basket capitals were adapted in Constantinople; however, decorated with two acanthi per side only. Both Alexandrian and Constantinopolitan models are contemporary; middle of the 6th century AD.
 - ▶ Melon capitals appeared in Constantinople after they were based on a Fold capital from Egypt; both models are contemporary; middle of the 6th century AD.
 - ▶ Bizonal capitals with both anthropomorphic and zoomorphic motifs appeared in Constantinople, but rather in a wider variety of models than those from Egypt; first half of the 6th century. However, there are earlier models from the 4th century AD in Constantinople.
 - ▶ Palm-Leaf capitals were in production in both Alexandria and Constantinople, based on the original models from the Ptolemaic and Roman Imperial periods.
 - ▶ Wind-Blown capitals are probably Alexandrian. Although data at hand are in favor of them being Syrian, both models are contemporary.

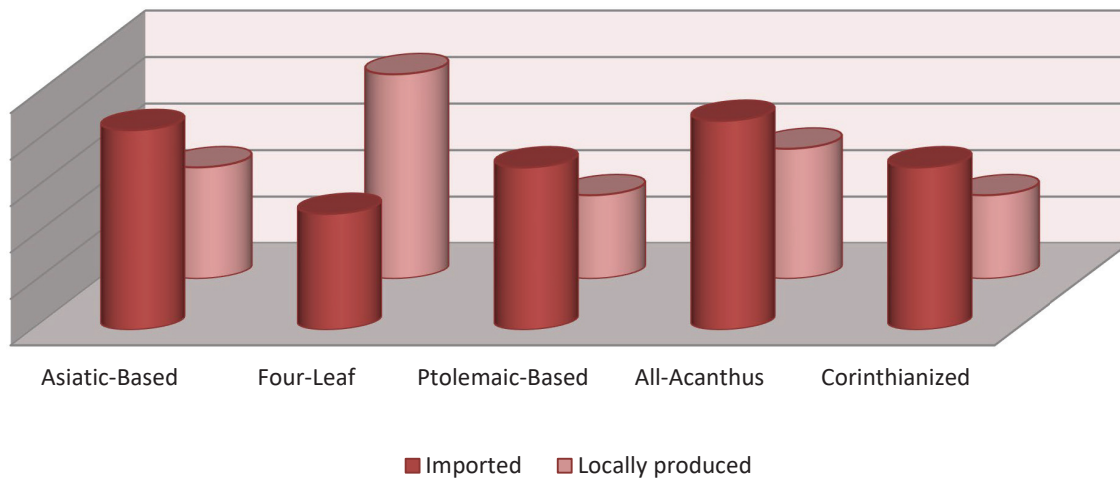

A chart showing the approximate usage of the various types of Corinthian capitals throughout Egypt in regards of their design and origin

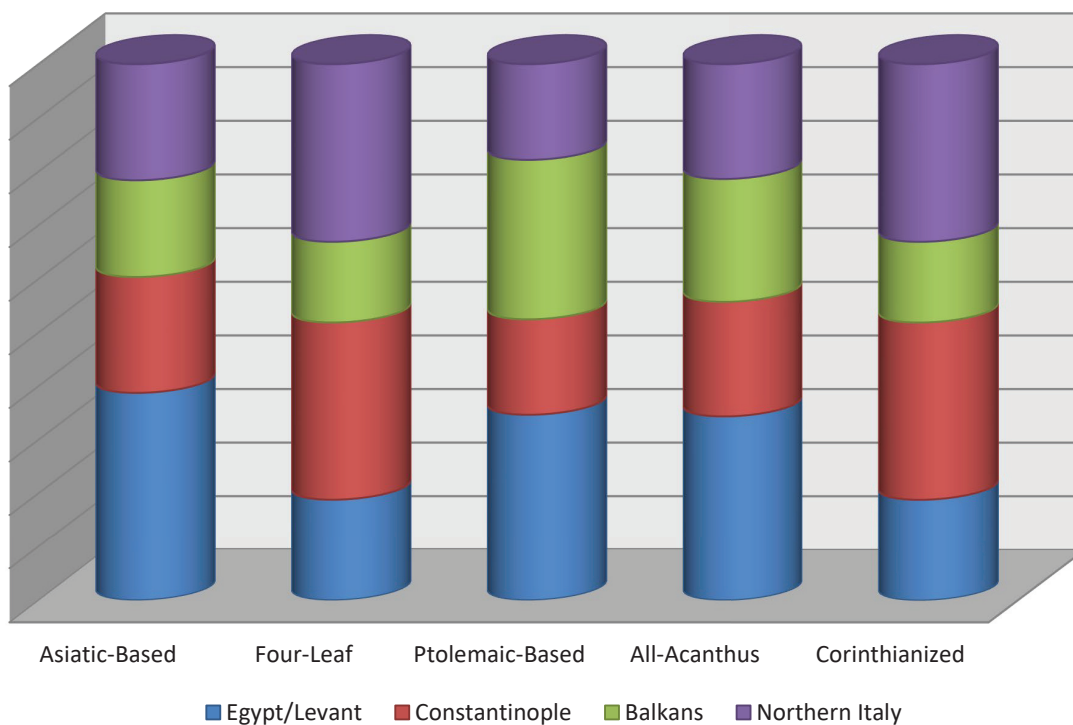

A chart showing the approximate usage of the various designs of Corinthian capitals inspired by those from Egypt in regards of their counterparts in Constantinople and the other Byzantine territories

Conclusion

After discussing the evolution of the Corinthian capital order throughout a period of 10 centuries, it is now possible to break down all its steps of evolution and rearrange them in terms of Alexandrian architecture. The Alexandrian Hellenistic architecture was mostly being shunned out from archeological books or referred to in a quick manner. The role of any architectural evolution in antiquity had always been attributed to Greece and Rome. The presence of Alexandria and its revolutionary styles had been neglected and replaced by the lesser Greek art from the same period. One cannot deny the supremacy of Greece in the Classical period but, in the Hellenistic period, the beacon had been snatched by Alexandria and even dominated the Hellenic lands themselves. Alexandrian architectural influence had stretched to the Byzantine period and even beyond the period discussed.

Starting with the Classical period, it is without doubt that the Corinthian capital is a product of Mainland Greece, followed by other examples from Asia Minor. The Corinthian capital was a sacred architectural order that was used for the interior decorations of temples, like that from the Temple of Apollo at Bassae, except for the Athenian Monument of Lysicrates. It was then used for the interior decorations of tholoi, like in Delphi, Epidaurus and Macedonia. The appearance of cauliculi and calyces began with the temples of Athena Alea and Nemean Zeus, and the Philippeion Monument. In the Hellenistic and early Roman imperial period, we can notice how Vitruvius had concluded a fixed ratio from the Epidauran capital, and other Hellenistic examples from the same period, for the canonization of the Corinthian capital.

In the first chapter about the Hellenistic period, two Classical prototypes were adapted in Hellenistic Alexandria; the Epidauran and the Double-Volute capitals. From the Epidauran emerged three types of capital, while the fourth was adapted from the Double-Volute one. For each of these Alexandrian, Egyptianized and Alexandrian-influenced Egyptian types, motifs had varied in design, size and source of influence; i.e. the acanthus leaves presented in several designs like the standard acanthi, vine leaves, and papyri.

Following the Ptolemaic marvel, other territories were influenced by Alexandrian architecture; both neighboring countries, and territories that eventually fell to the Ptolemaic dominance. This architectural influence had spread across a massive scale in regards of the Mediterranean Sea. The Alexandrian influence had been diverted into four paths across the Mediterranean: first, the Nabataean Kingdom had adapted two or three types from the Alexandrian capitals and developed their own version of Corinthian capitals. Such designs were used at the famous Khazneh Monument at Petra and simplified versions at El-Hijr. Second, territories like Ptolemais had developed a type of Corinthian capitals that focuses on the enlargement of the volutes and central fleuron, which eventually will influence Sicily, leading to the emergence of the Italo-Corinthian capitals. Third, the political marriage of Ptolemy II and his adaptation of the Arsinoeion capital at Samothrace for his Propylon had affected the Roman Capitoline; originally based on the capital of the Laodike Monument. Last, we can notice a two-way influence with the Egyptian culture itself, since we have Egyptianized version of the Corinthian capital and a Corinthianized version of the Composite Egyptian capital.

Regarding Nabataea, it is noticeable that by the Augustan period that "Floral capital" designs were adapted in Rome and Iberia. Regarding Samothrace, it was not a direct adaptation, since similar designs were evolved in Hermopolis Magna.

Another important point is raised. This question was named the "Antiochean Question." It discusses the territories of the East Mediterranean and what drove the architects of Antiochus IV in creating a new type of capitals for the Olympeion. As discussed, it should be clear by now that the capitals of the Olympeion are more than Hellenic, due to the presence of Seleucid, Indo-Hellenistic and Ptolemaic influences, circling around the Sanctuary of the Gods at Samothrace and the exquisite model of capitals at both the Rotunda of Arsinoe and the Propylon of Ptolemy II. This attributes the temple indirectly to Hellenistic Alexandria rather than Hellenic

Greece. However, the Antiochean Question does not end in the Hellenistic period, as it has another point of discussion related to the Late Republican period in Rome.

The second chapter covers a large period of time, part of which is contemporary to Hellenistic Alexandria, followed by the Roman Empire from Augustus until Constantine I. The first section focuses on the architectural development of the Corinthian capital in Southern Italy. The adaptation takes two forms, of which the first is the appearance of the Italo-Corinthian or Siculo-Corinthian capitals, probably based on the capitals from Ptolemais, while the second is about the pectoral adaptation of entire scenes from Alexandria throughout the Pompeian styles of wall painting. This will pave way to the appearance of the Proto-Composite capital and the adaptation of the Alexandrian styles in a more Romanized way.

The following section focuses on the military expansions of the Roman Republic throughout the Eastern Mediterranean region. Several territories in Greece and Asia Minor were conquered by 2nd century BC Roman generals. These generals had brought back spoils of wars, including architectural fragments. Also, they had monuments built in celebrations of these triumphs. These monuments were built in design of other monuments from the East witnessed by the generals during their expeditions. In other words, we can consider an indirect architectural invasion of the Hellenistic culture into the heart of the Roman Republic.

This brings us to the second part of the Antiochean Question, now related to General Regillius and the Temple of Lars Permarini or the Sanctuary of the Great Gods. This temple was built in imitation of the Hellenistic Sanctuary of the Gods at Samothrace. The Regillian Question breaks a hundred-year-old theory about the origin of the second phase of the Capitolium.

For almost a century, researchers had attributed the rebuilding of the Capitolium to the Sack of Athens under Sulla (87–86 BC). As discussed in Chapter II, the sacking happened three years prior to the destruction of the temple. Also, by reinterpreting ancient sources, we concluded that the Capitolium was built under the influence of the Hellenistic-based monuments in Rome from the 2nd century BC and its relation to the Sanctuary of the Great Gods – Lares Permarini (190 BC) was even built prior to the Antiochean construction of the Athenian Olympeion (174 BC). This theory attributes the Capitolium to Hellenistic Samothrace; hence Alexandrian Corinthian designs.

By the fall of the Roman Republic and the coronation of Augustus as the sole ruler of a new-born empire, the Italo-Corinthian, Floral Corinthian and Proto-Canonical capitals were present within the mentality of the Roman architect and artist. The period of Augustus was more of a stable period for both Alexandrian and Roman architecture; however, the Canonical/Orthodox Corinthian capital was introduced.

In Egypt, it was difficult to distinguish the Alexandrian capitals from the Late Ptolemaic and Augustan periods. This period was a transitional period of which the artists started to gradually abandon certain designs, modify other and introduce new or altered motifs. It was also the same period that witnessed the wide spread of the Floral capitals adapted from Nabataea in Rome and Iberia. Moreover, the Italo-Hellenistic capitals had found their way to Northern Italy and eventually in Rome as well but, it was on a much narrower scale in Rome.

However, in the Eastern provinces, another model had appeared. Although it was a mirror reflection of the newly-introduced Orthodox Corinthian capital from Rome, the Athenian capital model from the Odeion of Agrippa was closer in design to the capitals previously introduced throughout the Hellenistic period. This model will later pave way to the Asiatic types. Also, this model of Orientalized version of the Orthodox Corinthian capitals was used in Baalbek, Palmyra and Upper Egypt, like Hermopolis Magna. The usage of sharp acanthi was a feature of Eastern Mediterranean architecture; hence, Alexandria.

It was not until the 3rd century AD that different types of capitals were introduced throughout the empire and other from Egypt. With the reign of Hadrian, the Asiatic types of Corinthian capitals, probably from Aphrodisias, were widely used in Asia Minor and Greece. These capitals were originally recognized from their thorny acanthi. Later, features like crushed helices and elongated calyces will be added.

Throughout his tour in the Eastern Mediterranean, Hadrian had ordered the construction of several monuments, which eventually used the newly introduced Asiatic capitals. These Asiatic models had found their way into Rome, Egypt and Lepcis Magna. It was common that these capitals were imported either fully carved or partially, since they were marble capitals. Local artists were trained by Anatolian artists, passing the practice down to these local artists.

In Egypt, local artists had produced their own types of locally-carved capitals. These capitals were based on the Type I Alexandrian Corinthian from the Ptolemaic period. Three models were used across Alexandria and the rest of Egypt, along with rare usage of Types II and III. However, Asiatic types were widely spread in Egypt, resulting in the appearance of about 18 models, compared to the twenty one models that appeared in Rome, based on the imported Asiatic types. These Egyptian versions of the Asiatic capital were used as primary designs in cities like Hermopolis Magna, and buildings like the Bath House at Kom El-Dekka in Alexandria. These models will pave way to more capital designs that will appear in the Late Roman period.

In the third chapter, Alexandria and Constantinople were two reckoning forces in the field of architecture. Each city was both having the upper hand and under the influence of the other. The religious strife between both churches had found its roots deep within the artistic taste of both cities as well. This was reflected throughout both the materials used and the parallel designs produced from both cities. However, we can conclude that due to the wider range of models produced in Egypt that Egypt was the main source of influence in regards of architecture; hence, Corinthian and Corinthian-related capitals.

The earliest of these types was a type of capitals related to the Asiatic types that appeared under Hadrian and remained used until the age of Diocletian and Constantine the Great. These capitals were produced in marble from the Island of Proconnesus near Constantinople, replacing the Aphrodisian models and renaming them as Byzantine models. These models were imported in Egypt in either carved or semi-carved versions, like the Asiatic types. In Egypt, similar designs that already predated the marble ones were produced using limestone.

These Asiatic-based capitals were produced with specific features that facilitated their division into three subgroups: capitals with volutes emerging from calyces, capitals with volutes emerging directly from the acanthus collar, and capitals with volutes in a disorganized manner. The later was only produced in Egypt.

Another type of capitals was carved in a reduced form. These capitals focused around having four leaves by the lower corners of the capitals. They were usually produced in a trapezoid shape. They were either carved with V-shaped volutes or without; both cases recall the design of the Type IV Alexandrian Corinthian capital from the Hellenistic period. This type of capitals had appeared in the Balkans at a very late period; c. 6th century AD.

Certain capitals had adapted the Proto-Orthodox Corinthian capitals, like the capitals from Samothrace or a simplified version of the canonical capitals, like the capital from the Column of Diocletian. This could be considered an independent movement from the local artists to revive the Ptolemaic/Hellenistic types of capitals, but within the concept of Coptic art and the wide-spread designs of the reduced capitals.

Excessive use of acanthi was found in Upper Egypt. A type of capitals was known for the acanthization of all its motifs. Not only was the collar acanthus, but also the leaves of the calyx and their elongation to replace the volutes and helices, all the way towards the bottom of the abacus. There are no parallel examples for this type in Constantinople, mainly Coptic, like those from the Red Monastery in Sohag.

Several designs originated in Egypt were used across the Byzantine Empire. Impost, Basket, Melon, Bizonal, Palm-Leaf and Wind-Blown capitals were found throughout monasteries in Egypt, like Bawit and Saqqarah. Other capitals from Alexandria were used in Constantinople and Ravenna, like the Impost capitals. Melon capitals were adapted in Constantinople. Wind-Blown capitals were adapted in Thessaloniki, etc... This leads to the conclusion of the wide spread of Alexandrian capitals across the territories of the Byzantine Empire.

Therefore, we can conclude that Alexandrian Hellenistic art had a firm footing in the Mediterranean, including two Roman capitals, until the end of the 6th century AD, in regards of Antiquity. From Alexandria, Arab, Hellenic, Anatolian, Latin and Ostrogoth empires and kingdoms had adapted the Alexandrian art and its Corinthian variations. Developed capitals in South Italy, Balkans, South Jordon, Greece, Asia Minor, and even Rome and Constantinople themselves were under the Alexandrian dominance in regards of the Corinthian order and its evolution. Even in later centuries, models that were abandoned in Egypt and Alexandria were adapted and/or modified in other Roman and Byzantine territories. Both fully developed and simplified versions were in use across the Mediterranean for centuries. We can finally consider Alexandria as the source of influence for the evolution of the Corinthian capital across three periods of time and the Mediterranean Sea and beyond as well.

Bibliography

Sources

- Athenaeus, *Deipnosophistae*, Book V.
- Dio, Cassius, *Roman History*, Book LVI.
- Dionysius of Halicarnasus, *Roman Antiquities*, Book IV.
- Palladio, Andrea, *The Four Books of Architecture*, Book IV.
- Pliny, *Natural History*, Book XXXVI.
- Plutarch, *Life of Publicola*, Book XV.
- Vitruvius, *On Architecture*, Book IV.

References

- Abramson, H. "The Olympieion in Athens and its Connections with Rome." *California Studies in Classical Antiquity*, 7, University of California Press, 1974, pp. 1 – 25.
- Adriani, A. *Annuaire du Musee Gréco-Romain (1935-1939)*. Imprimerie de la Société de Publications Égyptiennes, 1940.
- Adriani, A. "Scavi e scoperte alessandrine." *Bulletin de la Société Archéologique d'Alexandrie* 41, Société de publications égyptiennes, 1949 - 1952, pp. 1-48.
- Adriani, A. *Repertorio d'arte dell'Egitto greco-romano, Serie C: Topografia e Architettura, I, II*. Fondazione Ignazio Mormino del Banco di Sicilia, 1966.
- Adriani, A. *Lezioni sull'arte alessandrina*. Libreria scientifica editrice, 1972.
- Al-Hijr Archeological Site (Madain Saleh): Nomination Document for the Inscription on the UNESCO World Heritage List*, n.p., 2007.
- Anderson, B. "Imperial Legacies, Local Identities: References to Achaemenid Persian Iconography on Crenelated Nabataean Tombs." *Ars Orientalis* 32, Freer Gallery of Art, The Smithsonian Institution and Department of the History of Art, University of Michigan, 2002, pp. 163 – 207.
- Anderson Jr., J. C. *Roman Architecture in Provence*. Cambridge University Press, 2013.
- Bagnall, R. & Rathbone, D. (eds.) *Egypt from Alexander to the Early Christians: an Archeological and historical Guide*. American University in Cairo Press, 2004.
- Baily, D. M. *Excavations at El-Ashmunein IV: Hermopolis Magna: Buildings of the Roman Period*. British Museum Press, 1991.
- Baily, D. M. "Classical Architecture." Riggs, C. (ed.) *The Oxford Handbook of Roman Egypt*. Oxford University Press, 2012.
- Behemerid, M. A. G. "Sobre la Sistematizacion del Capitel Corintio en la Peninsula Iberica." *Boletin del Seminario de Estudios de Arte y Arqueologia* 49, Ediciones Universidad de Valladolid, 1983a, pp. 25 – 44.

- Behemerid, M. A. G. "El Capitel Corintizante. Su Difusion en la Peninsula Iberica", *Boletin del Seminario de Estudios de Arte y Arqueologia* 49, Ediciones Universidad de Valladolid, 1983b, pp. 73 – 104.
- Behemerid, M. A. G. "Capiteles Romanos de la Provincia de Alicante", *Boletin del Seminario de Estudios de Arte y Arqueologia* 51, Ediciones Universidad de Valladolid, 1985, pp. 93 – 106.
- Behemerid, M. A. G. "Capiteles Romanos de la Peninsula Iberica", *Boletin del Seminario de Estudios de Arte y Arqueologia* 52, Ediciones Universidad de Valladolid, 1986, pp. 83 – 141.
- Bernard P. "Chapiteaux corinthiens hellénistiques d'Asie centrale découverts à Aï Khanoum." *Syria* 45.1-2, Institut Francais du Proche-Orient, 1968. pp. 111-151.
- Bernard, S. G. "The Two-Piece Corinthian Capital and the Working Practice of Greek and Roman Masons." Ousterhaut, R., Holod, R. and Haselberger L. (eds.) *Architecture and Construction in the Pre-Modern World*. Center for Ancient Studies/University of Pennsylvania, 2012.
- Bégule, L & Berthaud, E. "Les chapiteaux byzantins à figures d'animaux ; à propos de quatre chapiteaux découverts à Lyon" *Bulletin Monumental* 75, A. Picard Libraire, 1911, pp. 199 – 211.
- Boardman, J. *Greek Art*. Thames and Hudson, 1989.
- Boehm, R., Master, D. M. and Le Blanc, R. "The Basilia, Bouleuterion, and Civic Center of Ashkelon." *American Journal of Study* 120.2, Archeological Institute of America, 2016, pp. 271 – 324.
- Böethius, A. *Etruscan and Early Roman Architecture*. Yale University Press/Pelican History of Art, 1978.
- Botti, G. *Catalogue des monuments exposés au musée gréco-romain d'Alexandrie*. Imprimerie Générale A. Mourés, 1901.
- Boyd, M. J. "The Porticoes of Metellus and Octavia and their Two Temples." *Papers of the British School at Rome* 21, British School at Rome, 1953, pp. 152 – 159.
- Boube, J. "Chapiteaux de l'antique tardive et du haut moyen age dans le comminges et le Toulousain", *Pallas Hors-série*, Universités de Toulouse Le Mirail, 1986, pp. 413 – 456.
- Carroll, M. & Godden, D. "The Sanctuary of Apollo at Pompeii: Reconsidering Chronologies and Excavation History." *Archaeological Institute of America* 104.4, American Journal of Archaeology, 2000, pp. 743 – 754.
- Chitham, R. *The Classical Orders of Architecture*. Architectural Press, 2005.
- Cockerell, C. *The Temples of Jupiter Panhellenius at Aegina and of Apollo Epicurius at Bassae near Phigaleia in Arcadia*. John Weale, 1860.
- Coletta, A. "Analisi della lavorazione degli elementi architettonici del tempio di Apollo Sosiano." *Bulletino della Commissione Archeologica Comunale di Roma* 112, L'Erma di Bretschneider, 2011, pp. 179 – 190.
- Cormack, R. *Byzantine Art*. Oxford University Press, 2018.
- Cruikshank, D. *Sir Banister Fletcher's A History of Architecture: the 20th Edition*. Architectural Press, 1996.
- D'Espouy, H. *Greek and Roman Architecture in Classic Drawings*. Dover Publications, 1999.
- Dally, O. "Die Architekturfragmente aus Terrakotta und Kalkstein." *Institut für Klassische Archäologie Heidelberg/Sammlung Antiker Kleinkunst Sammlung Antiker Kleinkunst* 7, Philipp von Zabern Publishing House, 2006.

- Dalton, O. M. *Byzantine Art and Archeology*. Clarendon Press, 1911.
- Daszewski, W. A. "Nouvelles découvertes dans le quartier de Basileia en Alexandrie." *Études et Travaux: Centre d'archéologie méditerranéenne de l'Académie polonaise des sciences* 11, Institut français d'archéologie orientale, 1979, pp. 91–105.
- De Maria, S. "Aspetti e Problemi della Decorazione Architettonica Romana in Romauna eta Tardo-Repubblicana e Auüustea." *Studi Romagnoli* 28, Società di Studi Romagnoli, 1977, pp. 565 – 616.
- De Maria, S. "Il Problema del corinzio-italico in Italia settentrionale: A proposito di un capitello non finite di Rimini." *Melanges de l'Ecole française de Rome* 93.2, n.p. 1981, pp. 565 – 616.
- De Stefano, F. "Porticus Metelli-Porticus Octaviae. Sota di un Monumento Trionfale nel cuore della Rome di oggi." *Forma Urbis* 10, n.p. 2015, pp. 40 – 50.
- Densmore, C. "Roman Monumental Arches." *Supplementary Papers of the American School of Classical Studies in Rome* 2, University of Michigan Press/the American Academy in Rome 1908, pp. 26 – 83.
- Deliyannis, D. M. *Ravenna in Late Antiquity*. Cambridge University Press, 2010.
- Dinsmoor, W. "The Temple of Apollo at Bassae." *Metropolitan Museum Studies* 4, The Metropolitan Museum of Art, 1933, pp. 204 – 227.
- Dinsmoor, W. *The Architecture of Ancient Greece*, B. T. Batsford LTD, 1950.
- Dwyer, E. "The Unified Plan of the House of the Faun." *Journal of the Society of Archeological Historians* 60.3, University of California Press/Society of Architectural Historians, 2001, p. 328 – 329.
- Donovan, M. "House of the Faun, Pompeii." *Agni* 76, Agni, 2012, pp. 26 – 33.
- Empereur, J.-Y. *Alexandria Rediscovered*. British Museum Press, 1998.
- Fedak, J. *Monumental Tombs of the Hellenistic Age*. University of Toronto Press, 1990.
- Fiasco, A. "Praeneste, Fortuna Primigenia e il suo santurio a piu di settant'anni della sua (ri)scoperta." Merz, J. *M. Il Santuario della Fortuna in Palestrina*, Massimo Guerrini Editore, 2016, pp. 81 – 95.
- Fletcher, B. *History of Architecture*. B. T. Batsford LRD, 1905.
- Fragaki, H. & Guimer-Sorbets, A.-M. "Un édifice inachevé du quartier royale á Alexandrie: Études suivie d'un fragment de cornice peinte hellénistique á Alexandrie." *Études Alexandrines* 31, Centres d'études alexandrines, 2013.
- Fraser, A. D. "The Age of Extant Columns of the Olympieum at Athens." *The Art Bulletin* 4, College Art Association, 1921, pp. 5 – 18.
- Landucci, F. "THE SANCTUARY OF THE GREAT GODS AT SAMOTHRACE AND THE RULERS OF THE EARLY HELLENISM." *Aevum* 89.1, Vita e Pensiero – Pubblicazioni dell'Università Cattolica del Sacro Cuore, 2015, pp. 67 – 82.
- Fyfe, T. *Hellenistic Architecture*. Cambridge University Press, 1936.
- Gabra, G. *Coptic Monasteries: Egypt's Monastic Art and Architecture*. American University Press in Cairo, 2002.
- Gabra, G. & Eaton-Krauss, M. *The Illustrated Guide to the Coptic Museum and Churches of Old Cairo*. American University Press, 2007.

- Gans, U.-W. "Rezension zu: Heide Lauter-Bufe, Die Geschichte des sikeliotisch-korinthischen Kapitells. Der sogenannte italisch-republikanische Typus." *Bonner Jahrbucher* 90, n.p. 1990, p. 691 & 692.
- Gans, U.-W. "Hellenistische Architekturteile aus Hartgestein in Alexandria". *Archäologischer Anzeiger*, n.p. 1994, pp. 433 – 453, Abb. 1 – 19.
- Geymonat, L. V. "The Syntax of *Spoila* in Byzantine Thessaloniki", *Approaches to Byzantine Architecture and its Decoration: Studies in Honor of Slobodan Ćurčić*, Routledge, 2012, pp. 47 – 66.
- Gütschow, M. "Untersuchungen zum korinthischen Kapitell." *Jahrbuch Deutschen Archäologischen Instituts* 21, Walter de Gruyer & Co., 1921, pp. 44 – 83.
- Gorrie, C. "The Restoration of the Porticus Octaviae and Severan Imperial Policy." *Greece & Rome: Second Series* 54.1, Cambridge University Press/The Classical Association, 2007, pp. 1 – 17.
- Grossman, P. "Early Christian architecture in Egypt and its relationship to the architecture of the Byzantine World." Bagnall, R. (ed.) *Egypt in the Byzantine World, 300-700*, Cambridge University Press, 2010.
- Handler, S. "Architecture on the Roman Coins of Alexandria." *American Journal of Archeology* 75.1, Archeological Institute of America, 1971, pp. 57 – 74.
- Hammoud, P. C. "The Capitals from 'The Temple of the Winged Lions' in Petra." *Bulletin of the American Schools of Oriental Research* 226, The University of Chicago/The American Schools of Oriental Research, 1977, pp. 47 – 51.
- Hoddinott, R. F. *Early Byzantine Churches in Macedonia and Southern Serbia: A Study of the Origins and Initial Development of East Christian Art*. Palgrave Macmillan, 1963.
- Howe, T. N. "Hellenistic Architecture in Italy: *Consuetudo Italica*", *A Companion to Greek Architecture*. Wiley Blackwell, 2016, pp. 470 – 486.
- Jackson, T. G. *Byzantine and Romanesque Architecture I*. Chicago University Press, 1913.
- Jacobelli, L. & Pensabene, P. "La decorazione architettonica del Tempio di Venere a Pompei: contributo allo studio e alla ricostruzione del santuario." *Rivista di Studi Pompeiani* 7, 1995-96, L'Erma di Bretschneider, pp. 45 – 75.
- Jones, O. "Roman Ornament." *The Grammar of Ornament: Visual Reference of Form and Colour in Architecture and the Decorative Arts*. Princeton University Press, 2016, pp. 124 – 135.
- Jones, M. W. "Designing the Roman Corinthian Capital." *Papers of the British School at Rome* 59, British School at Rome, 1991, pp. 89 – 150.
- Jones, M. W. "Genesis and Mimesis: The Design of the Arch of Constantine in Rome." *Journal of the Society of Architectural Historians* 59.1, University of California Press/Society of Architectural Historians, 2000, pp. 50 – 77.
- Joukowsky, M. S. "The Petra Temple: A Nabataean Architectural Miracle." *Near East Archeology* 65.4, University of Chicago Press/American Schools of Oriental Research, 2002, pp. 235 – 248.
- Kennedy, A. "The Rocks and Monuments of Petra." *The Geographical Journal* 63.4, The Royal Geographical Society (with the Institute of British Geographers), 1924, pp. 273 – 295.
- Kahwagi-Janho, H. "Chapiteaux corinthiens d'époque romaine à Tyr." *Institut Francais du Porche-Orient* 91, Syria, pp. 319 – 350.

- Kimball, F. and G.H. Edgell. *A History of Architecture*. Harper & Row, 1972.
- Kolataj, W. *Alexandrie VI: Imperial Baths at Kom El-Dikka*, Archeobooks, 1992.
- Kostenec, J. & Dark, K. *Hagia Sophia in Context: An Archeological Re-Examination of the Cathedral of Byzantine Constantinople*. Oxbow books, 2019.
- Kostof, S. *A History of Architecture: Settings and Rituals*. Oxford University Press, 1995.
- Krautheimer, R. *Early Christian and Byzantine Architecture*. Yale University Press, 1965.
- Kubiak, W. "Les Fouilles Polonaises à Kôm El Dick". *Bulletin de la Société Archéologique d'Alexandrie* 42, Institut français d'archéologie orientale 1967, pp. 47 – 80.
- Landucci, F. "The Sanctuary of the Great Gods at Samothrace and the Rulers of the Early Hellenism." *Aevum* 89.1, Vita e Pensiero – Pubblicazioni dell'Universita Cattolica del Sacro Cuore, 2015, pp. 67 – 82.
- Lauter, H. "Porticus Metelli - Porticus Octaviae: Die baulichen Reste." *Bullettino della Commissione Archeologica Comunale di Roma* 87, L'Erma di Bretschneider, 1980-1, pp. 37 – 46.
- Lawrence, A. *Greek Architecture*. Yale University Press, 1983.
- Lusnia, S. S. "Urban Planning and Sculptural Display in Severan Rome: Reconstructing the Septizodium and its Role in Dynastic Politics", *American Journal of Archeology* 108.4, Archaeological Institute of America, 2004, pp. 517 – 544.
- MacDonald, W. *Early Christian & Byzantine Architecture*. George Braziller Publication, 1979.
- Mango, C. *Byzantine Architecture*. Electra Editrice, 1978.
- Maniatis, Y., et al, " the Sanctuary of the Great Gods on Samothrace, Greece: an extended marble provenance study, Interdisciplinary studies on Ancient Stone", *Documenta* 23, Institut Català d'Arqueologia Clàssica, 2012, pp. 263 – 278.
- Martinez-Sève, L. The Spatial Organization of Ai Khanoum, a Greek City in Afghanistan." *American Journal of Archaeology* 118.2, Archeological Institute of America, 2014, pp. 267 – 283.
- Marquand, A. "A Capital from the Temple of Jupiter Capitolinus in Rome." *American Journal of Archeology*, 2.1/2.2, Archeological Institute of America, 1898, pp. 19 – 25.
- Màrquez, C. "Capiteles Corintizantes en la villa de Adriano en Tívoli. Tipologías y talleres" *Revista del Seminario de Arqueologia de la Universidad Pablo de Olavide de Sevilla*, Romvla 14, 2015, pp. 187 – 220.
- Majcherek, G. "Crumbs from the Table: Archaeological Remains of Hellenistic Alexandria." Zerefos, C. S. & Vardinoyannis, M. V. (eds.) *Hellenistic Alexandria: Celebrating 24 Centuries, Proceedings of the conference held on December 13-15 2017 at the Acropolis Museum, Athens*. Archaeopress Archeology, 2018, pp. 71 – 85.
- Mau, A. *Pompeii: Its Life and Art*. MacMillan & Co. LTD, 1899.
- McKenzie, J. *The Architecture of Petra*. Oxford University Press, 1990.
- McKenzie, J. "Alexandria and the Origins of Baroque Architecture." *Alexandria and Alexandrianism*. The J. Paul Getty Museum, 1993, pp. 109 – 125.

- McKenzie, J. "Keys from Egypt and the East: Observations on Nabataean Culture in the Light of Recent Discoveries". *Bulletin of the American School of Oriental Research*, 324, The University of Chicago Press/The American Schools of Oriental Research, 2001, pp. 97 – 112.
- McKenzie, J. Gibon, S. & Reyes, A. T. "Reconstructing the Serapeum in Alexandria from the Archeological Evidence", *The Journal of Roman Studies* 94, 2004, pp. 73 – 121.
- McKenzie, J. *Architecture of Alexandria and Egypt: 300 BC – AD 700*. Yale University Press, 2007.
- Meinardus, O. F. A. *Two Thousand Years of Coptic Christianity*. American University in Cairo Press, 2002.
- Milburn, R. *Early Christian Art and Architecture*. University of California Press, 1988.
- Nassar, M. "Corinthian Capitals with Interlocked Helices from Roman Period, Jordan: A Comparative Study." *Mediterranean Archeology and Archaeometry* 14.1, The University of the Aegean, 2013, pp. 167 – 179.
- Negipoğlu, N. (ed.) "Byzantine Constantinople: Monuments, Topography and Everyday Life." Kennedy, H. et al (eds.) *The Medieval Mediterranean: Peoples, Economics and Cultures, 400-1453* 33, Brill, 2001.
- Norman, N. "The Temple of Athena Alea at Tegea." *American Journal of Archeology* 88.2, Archeological Institute of America, 1984, pp. 169 – 194.
- Ousterhout, R G. *Eastern Medieval Architecture: the Building Traditions of Byzantium and Neighboring Lands*, Oxford University Press, 2019.
- Papalexandrou, A. "Polis/Arsinoë: A Cypriot Town and its Sacred Sites", *Approaches to Byzantine Architecture and its Decorations: Studies in Honor of Slobodan Ćurčić*. Routledge, 2012, pp. 27 – 46.
- Peleg-Barkat, O. "Fit for a King: Architectural Decor in Judaea and Herod as Trendsetter." *Bulletin of the American Schools of Oriental Research* 371, The University of Chicago Press/The American Schools of Oriental Research, 2014, pp. 141 – 161.
- Pensabene, P. "La decorazione architettonica, l'impiego del marmo e l'importazione di manufatti orientali a Roma, in Italia e in Africa (II-VI d.c.)." *Società romana e impero tardoantico III*, Editori Laterza, 1986, pp. 285 – 429.
- Pensabene, P. "Architettura imperial in Egitto", *Roma e l'Egitto nell'antichità classica: Cairo, 6-9 Febbraio 1989*, Istituto Poligrafico e Zecca dello Stato/Libreria dello Stato, 1992, pp. 273 – 198.
- Pensabene, P. "Reportorio d'arte dell'Egitto Greco-Romano." *Elementi architettonici di Alessandria e di altri siti egiziani*. Serie C: 3, L'Erma di Bretschneider, 1993.
- Pensabene, P. "Programmi decorativi e architettura del tempio di Antonino e Faustina al Foro Romano", *Studi Miscellanei* 29, L'Erma di Bretschneider, 1996, pp. 239 – 269.
- Pensabene, P. "Pentelico e proconnesio in Tripolitania: coordinamento o concorrenza nella distribuzione?" *Archeologica Classica* 52, L'Erma di Bretschneider, 2018, pp. 63 – 127.
- Pensabene, P. "Villa A di Oplontis: elementi della decorazione architettonica in marmo." *Rivista di Studi Pompeiani* 29, L'Erma di Bretschneider, 2018a, pp. 45 – 86.
- Pensabene, P. "Tradizioni architettoniche alessandrine nell'Egitto Romano", *Sicilia Antiqua: an International Journal of Archeology* XV, Fabrizio Serra Editore, 2018b, 407 – 422.
- Petras, P. *Delphi: Monuments and Museum*. Krene Editions, 1981.

- Pfrommer, M. "Roots and Contacts: Aspects of Alexandrian Craftsmanship." *Alexandria and Alexandrianism*. The J. Paul Getty Museum, 1993, pp. 171 – 189.
- Pfrommer, M. *Alexandria. Im Schatten der Pyramiden*. Zabern, 1999.
- Pollitt, J. J. *Art in the Hellenistic Age*. Cambridge University Press, 1896.
- Popkin, M. L. "Samothracian Influences at Rome: Cultic and Architectural Exchange in the Second Century B.C.E." *American Journal of Archeology* 119.3, Archeological Institute of America, 2015a, pp. 343 – 373.
- Popkin, M. L. "Decorum and the Meanings of Materials in Triumphal Architecture of Republican Rome." *Journal of the Society of Architectural Historians* 74.3, University of California Press/the Society of Architectural Historians, 2015b, pp. 289 – 311.
- Pralong, A. "La Typologie des Chapiteaux Corinthiens Tardifs en Marbre de Proconnese et la Production d'Alexandrie." *Revue Archéologique Nouvelle Série* 1, Presses Universitaires de France, 2001, pp. 81 – 101.
- Quinn, J. C. & Wilson, A., "Capitolina", *Journal of Roman Studies* 103, Cambridge University Press, 2013, pp. 117 – 173.
- Riad, H. "Vestiges d'un édifice ptolémaïque en bordure de la voie canopique à Alexandrie". *Bulletin de la Société Archéologique d'Alexandrie* 42, IFAO, 1967 pp. 85 – 88.
- Richardson Jr., L. "The Evolution of Porticus Octaviae." *American Journal of Archeology* 80.1, Archeological Institute of America, 1976, pp. 57 – 64.
- Richter, G. *A handbook of Greek Art*. The Phaidon Press, 1982.
- Rhodes, E. F. "Early Corinthian Order and the Origins of the Doric Order". *American Journal of Archaeology* 91.3, Archeological Institute of America, 1987, pp. 477-480.
- Robertson, D. *A Handbook of Greek and Roman Architecture*. Cambridge University Press, 1929.
- Rodziewicz, M. and Abdel Fattah, Ahmed. "Recent Discoveries in the Royal Quarter of Alexandria". *Bulletin de la Société Archéologique d'Alexandrie*, 44, n.p., 1991, pp. 131 – 150.
- Rodziewicz, M. and Abdel Fattah, Ahmed. "A Brief Record of the Excavations at Kom-el-Dikka in Alexandria from 1960 to 1980". *Bulletin de la Société Archéologique d'Alexandrie*, 44, n.p. 1991, pp. 1 – 70.
- Rodziewicz, M. and Abdel Fattah, Ahmed. "Eco-Archaeology of Ancient Alexandria and Mareotis". Hussein, A.A.A. et al. (eds.), *Proceedings of the Egyptian – Italian Seminar on Geosciences and Archaeology in the Mediterranean Countries*, Geological Survey of Egypt Publishing, 1993, pp. 135 – 146.
- Rekowska, M. "In Search of Ptolemaic Palaces..." *Ex Oriente Lux. Studies in Honour of Jolanta Młynarczyk*, Warsaw University Press, 2020.
- Ronczewski, K. "Variantes des Chapiteaux Romains: Matériaux pour l'Etude de l'Art Decoratif." *Annales de l'Université de Latvie* 8, 1923.
- Ronczewski, K. "Description des Chapiteaux Corinthiens et Variés." *Bulletin de la Société Archéologique d'Alexandrie*, 22, Société de publications égyptiennes, 1927.
- Sabottka, M. "Das Serapeum in Alexandria: Untersuchungen zur Aechitektur und Baugeschichte des Heiligtums von der frühen ptolemäischen Zeit bis zur Zerstörung 391 n. Chr.". *Etudes alexandrines*, 15, Institut français d'archéologie orientale, 2008.

- Schlumberger, D. "Les Formes Anciennes du Capiteau Corinthien en Syrie, en Palastine et en Arabie", *Syria* 14.3, Institut Francais du Proche-Orient, 1933, 283 – 317.
- Schmid, S. G. et al., "The Palaces of the Nabataean kings at Petra", *Proceedings of the Seminar for Arabian Studies* 42, Archeopress, 2012, pp. 73 – 98.
- Schreiber, T. "Expedition Ernst Sieglin: Ausgrabungen in Alexandria." *Die Nekropole von Kom-esch-Schukafa*, Giesecke und Devrient, 1908.
- Sear, F. *Roman Architecture*. First ed., Routledge Press, 1982.
- Sear, F. *Roman Architecture*. Second ed., Routledge Press, 2021.
- Severin, H.-G. "On the Architectural Decoration and Dating of the Church of Dayr Anba Bisuy ("Red Monastery") near Suhag in Upper Egypt", *Dumbarton Oaks Papers* 62, Dumbarton Oaks, Trustees for Harvard University, 2008, pp. 75 – 112.
- Siwicki, C. *Architectural Restoration and Heritage in Imperial Rome*, Oxford University Press, 2020.
- Stamper, J. *The Architecture of Roman Temples*. Cambridge University Press, 2005.
- Stamper, J. "Urban Sanctuaries: The Early Republic to Augustus", Miles, M. M. (ed.) *A Companion of Roman Architecture*. Pondicherry, Blackwell Publishing, 2014, pp. 207 – 227.
- Staviskij, B. J. "The Capitals of Ancient Bactria." *East and West*, 23, No. 3/4, Istituto Italiano per l'Africa e l'Oriente, 1973, pp. 265 – 277.
- Strong, D. E., & Ward-Perkins, J. B. "The Round Temple in the Forum Boarium." *Papers of the British School at Rome*, 28, British School at Rome, 1960, pp. 7 – 32.
- Strong, D. E., & Ward-Perkins, J. B. "The Temple of Castor in Forum Romanum." *Papers of the British School at Rome*, 30, British School at Rome, 1962, pp. 1 – 30.
- Strong, D. E. "(Some) Observations on Early Corinthian Capital." *The Journal of Roman Studies*, 53.1 & 53.2, Society for the Promotion of Roman Studies, 1963, pp. 73 – 84.
- Texier, C. *Byzantine Architecture: Examples of Edifices Erected in the East during the Earliest Ages of Christianity*, Day & Son, 1864.
- Thomas, E. *Monumentality and the Roman Empire*. Oxford University Press, 2007.
- Tkaczow, B. *The Topography of Ancient Alexandria: An Archaeological Map*. Travaux du Centre d'Archéologie Méditerranéenne de L'Academie Polonaise des Sciences. Tome 32, Varsovie, 1993.
- Tkaczow, B. *Alexandrie VIII: Architectural Styles of Ancient Alexandria. Elements of Architectural Decoration from Polish Excavations at Kom el-Dikka (1960-1993)*. Centre d'Archéologie Méditerranéenne de l'Academie Polonaise des Sciences, Alexandrie VIII, Varsovie, 2008.
- Tourtet, F. and Weigel, F. "Tayma in the Nabataean Kingdom and in Provincia Arabia." *Proceedings of the Seminar for Arabian Studies* 45, Archeopress, 2015, 165 – 182.
- Wace, A. J. B., Megaw, A. H. S., and Skeat, T. C., with Shenouda, S. *Hermopolis Magna, Ashmunein: The Ptolemaic Sanctuary and the Basilica*. Alexandria University Press, 1959.
- Williams, C. "The Corinthian Temple of Zeus Olbios at Uzuncaburc: A Reconstruction of the Date." *American Journal of Archeology* 78.4, Archeological Institute of America, 1974, pp. 405 – 414.

- Ward-Perkins, J. B. "Severan Art & Architecture at Lepcis Magna", *The Journal of Roman Studies* 38.1-2, Society for the Promotion of Roman Studies, 1948, pp. 1948.
- Ward-Perkins, J. B. "Art and Architecture at Lepcis Magna." *The Journal of Roman Studies* 38.1 & 38.2, Society for the Promotion of Roman Studies, 1958, pp. 59 – 80.
- Ward-Perkins, J. B. "An Early Augustan Capital in the Forum Romanum." *Papers of the British School at Rome*, 35, British School of Rome, 1967, pp. 23 – 28.
- Ward-Perkins, J. B. *Roman Imperial Architecture*. Yale University Press, 1981.
- Weitzmann, K. W. *Age of Spirituality: Late Antique and Early Christian Art, Third to Seventh Century (Catalogue of the exhibition at the Metropolitan Museum of Art, November 19, 1977 through February 12, 1978)*. The Metropolitan Museum of Art/Princeton University Press, 1979.
- Winter, F. *Studies in Hellenistic Architecture*. University of Toronto Press, 2005.
- Yegül, F & Favro, D. *Roman Architecture and Urbanism: From the Origins to Late Antiquity*, Cambridge University Press, 2019.
- Zink, S. "Reconstructing the Palatine Temple of Apollo: A Case Study in Early Augustan Temple Design." *Journal of Roman Archeology* 21, Cambridge University Press, 2008, pp. 47 – 63.

Websites:

- Column of Aelia Eudoxia. *The Byzantine Legacy*, 6 May 2021, thebyzantinelegacy.com/eudoxia-column
- Column of Marcian. *The Byzantine Legacy*, 4 May 2021, thebyzantinelegacy.com/marcian-column
- Episcopal Complex of the Euphrasian Basilica in the Historic Centre of Poreč. UNESCO, 8 May 2021, whc.unesco.org/en/list/809/
- Hagia Sophia. *My World of Byzantium*, 8 May 2021, pallasweb.com/deesis/columns-and-capitals-of-hagia-sophia.html
- Theotokos Kyriotissa. *The Byzantine Legacy*, 4 May 2021, thebyzantinelegacy.com/kyriotissa
- Sultan Cistern. *The Byzantine Legacy*, 6 May 2021, thebyzantinelegacy.com/sultan-cistern

